

# **SIMPLIFIED METHOD FOR PLATE DEFLECTION CALCULATION**

**Mohammed S. Al-Ansari**

Assistant Professor, Department of Civil Engineering  
University of Qatar, Doha, Qatar.

## **ABSTRACT**

This paper presents a simplified method for the calculation of thin-plate deflections. The method, which deals with uniformly loaded plates, uses the stiffness method to obtain plate deflection equations for specified boundary conditions. A case study was presented in order to demonstrate the use of the proposed method and to illustrate its capabilities. The results obtained were in close agreement with those obtained analytically and with those obtained using the finite element methods. Finally, a user-friendly program for plate deflection calculations based on the proposed method was developed using the mathematical package MATHCAD.

**Keywords:** Plate, Deflection, Stiffness, MATHCAD

## **INTRODUCTION**

A flat plate is a structural element whose thickness is relatively small compared to its in-plane dimensions. A number of analytical methods, such as the equilibrium and energy methods, have been developed for the calculation of plate deflections. However, these methods are not always possible and one must resort to numerical methods such as the finite difference and the finite-element methods.

The finite difference method requires the solution of a set of simultaneous equations while the finite element method requires a mesh generation and a solution for a large stiffness matrix. Even though they are accurate and widely used, these numerical methods are costly since they require longer solution time and can only be implemented by qualified technical people. The high cost of these numerical solutions is not always justified especially in preliminary design cases where low accuracy results are still acceptable. For these cases, a less costly simplified method is usually more than adequate.

This paper presents a simplified method for plate deflection calculation. The proposed method uses the concept of the stiffness method to calculate the deflection of a plate with specified boundary conditions and subjected to a uniformly distributed load [Wang 1984 and Hsieh 1988]. A case study is presented to demonstrate the use of the simplified method and to show its capabilities. Finally, a program for plate deflection calculation was developed using the mathematical package MATHCAD.

### PROPOSED METHOD

Figure 1 shows a rectangular plate with in-plane dimensions  $a \times b$ . The plate, which has a specified boundary conditions, is subjected to a uniformly distributed load  $w(x,y)$ . The plate deflection equation is derived using the stiffness method. Fig. 2 shows the point  $n1$  where the plate deflection is sought. Fig. 3 shows the plate structural model. Based on the plates boundary conditions, the following cases of analysis are considered:

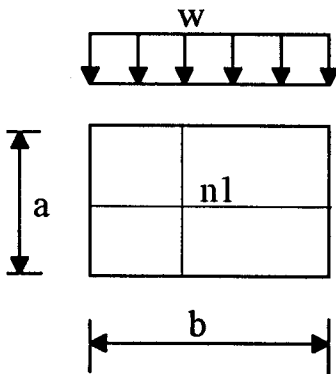

Fig. 1 Rectangular plate with in-plane dimensions  $axb$

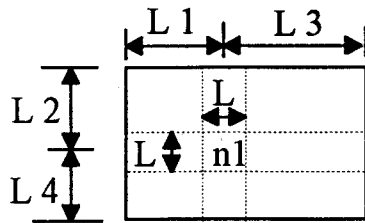

Fig. 2. Nodal point location

### Simplified Method for Plate Deflection Calculation

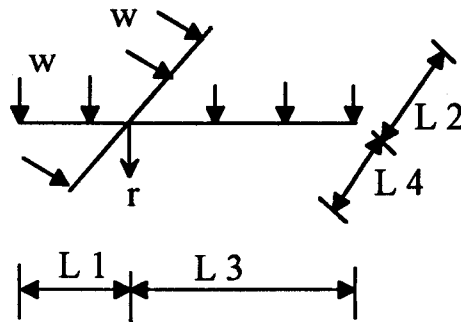

Fig. 3. Plate structural model

### Fixed Boundaries

Fig. 4 shows the structural model of the plate while Fig. 5 shows the internal element forces. The displacement matrix [a] is computed using the following equations:

$$[q] = [a] [r] \quad (1)$$

$$\begin{bmatrix} q_1 & q_2 & q_3 & q_4 & q_5 & q_6 & q_7 & q_8 \end{bmatrix}^T = \begin{bmatrix} -1 & -1 & -1 & -1 & -1 & -1 & -1 & -1 \\ L_1 & L_1 & L_3 & L_3 & L_4 & L_4 & L_2 & L_2 \end{bmatrix}^T [r] \quad (2)$$

The element stiffness matrix [k] is equal to:

$$[k] = \frac{D}{L} \begin{bmatrix} 4 & 2 & 0 & 0 & 0 & 0 & 0 & 0 \\ 2 & 4 & 0 & 0 & 0 & 0 & 0 & 0 \\ 0 & 0 & 4 & 2 & 0 & 0 & 0 & 0 \\ 0 & 0 & 2 & 4 & 0 & 0 & 0 & 0 \\ 0 & 0 & 0 & 0 & 4 & 2 & 0 & 0 \\ 0 & 0 & 0 & 0 & 2 & 4 & 0 & 0 \\ 0 & 0 & 0 & 0 & 0 & 0 & 4 & 2 \\ 0 & 0 & 0 & 0 & 0 & 0 & 2 & 4 \end{bmatrix} \quad (3)$$

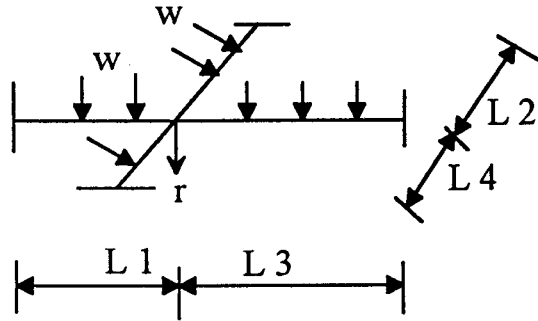

**Fig. 4 Plate structural model for fixed boundaries**

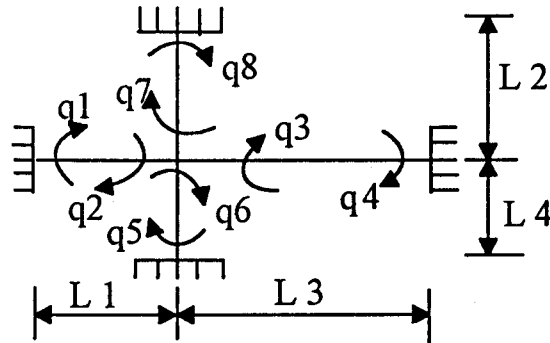

**Fig. 5. Plate internal element forces for fixed boundaries**

The flexural rigidity \$D\$ is given by the following equation:

$$D = \frac{E t^3}{12 (1 - \nu)} \quad (4)$$

where \$t\$ is the plate thickness, \$E\$ is the modulus of elasticity, \$\nu\$ is the Poisson's ratio, and \$L\$ is the member length. In our case \$L\$ is taken equal to unity (\$L=1\$).

The structure stiffness matrix \$[K]\$ is assembled using the following equation:

$$[K] = [a]^T [k] [a] \quad (5)$$

The load matrix [R] is given by the following equation:

$$[R] = \frac{w}{2}(L_1 + L_2 + L_3 + L_4) \quad (6)$$

Finally, the required displacement matrix [r] is obtained as follows:

$$[r] = [K]^{-1}[R] \quad (7)$$

$$[r] = \frac{L_1^2 L_2^2 L_3^2 L_4^2 w (L_1 + L_2 + L_3 + L_4)}{[24[D(L_3^2 L_4^2 L_2^2 + L_1^2 L_4^2 L_2^2 + L_1^2 L_3^2 L_2^2 + L_1^2 L_3^2 L_4^2)]]} \quad (8)$$

### Simply-Supported Boundaries

Figure 6 shows the structural model while Fig.7 shows the internal element forces. The required displacement matrix [r<sub>1</sub>] is given by the following equations:

$$[r_1] = [K]^{-1}[R] \quad (9)$$

$$[r_1] = \frac{L_1^2 L_2^2 L_3^2 L_4^2 w (L_1 + L_2 + L_3 + L_4)}{[6[D(L_3^2 L_4^2 L_2^2 + L_1^2 L_4^2 L_2^2 + L_1^2 L_3^2 L_2^2 + L_1^2 L_3^2 L_4^2)]]} \quad (10)$$

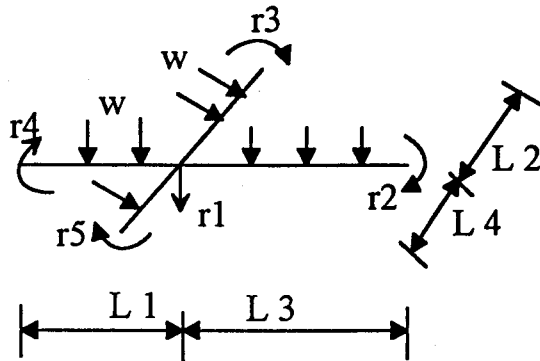
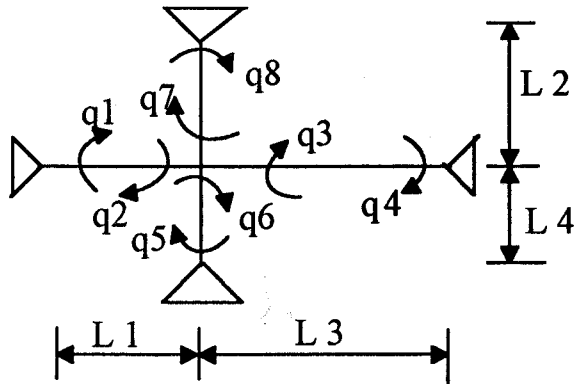

Fig.6. Plate structural model for simply-supported boundaries



**Fig.7. Plate structural model for simply-supported boundaries**

**Other Boundaries**

Table 1 summarizes the displacement matrices for a number of boundary conditions.

**Plates with Holes**

Figure 8 shows the structural model of a plate with a central hole. Only the plates with fixed boundaries and having holes in the center or very close to the center were considered herein. Table 2 summarizes the displacement matrices for the plates considered.

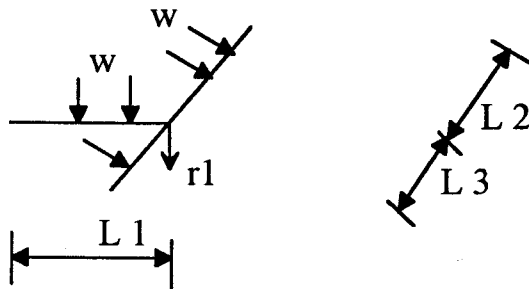

**Fig. 8. Structural model for a plate with a central hole**

Simplified Method for Plate Deflection Calculation

Table 1. Displacement Matrices for Regular Plates

No.	Case S => Simple F => Fixed	Vertical Displacement at any point ( $r$ )
1		$r = \frac{L1^2 \cdot L2^2 \cdot L3^2 \cdot L4^2 \cdot w \cdot (L1 + L2 + L3 + L4)}{24 \left[ D \cdot (L3^2 \cdot L4^2 \cdot L2^2 + L1^2 \cdot L4^2 \cdot L2^2 + L1^2 \cdot L3^2 \cdot L2^2 + L1^2 \cdot L3^2 \cdot L4^2) \right]}$
2		$r = \frac{L1^2 \cdot L2^2 \cdot L3^2 \cdot L4^2 \cdot w \cdot (L1 + L2 + L3 + L4)}{6 \left[ D \cdot (L3^2 \cdot L4^2 \cdot L2^2 + L1^2 \cdot L4^2 \cdot L2^2 + L1^2 \cdot L3^2 \cdot L2^2 + L1^2 \cdot L3^2 \cdot L4^2) \right]}$
3		$r = \frac{L1^2 \cdot L2^2 \cdot L3^2 \cdot L4^2 \cdot w \cdot (L1 + L2 + L3 + L4)}{6 \left[ D \cdot (L3^2 \cdot L4^2 \cdot L2^2 + L1^2 \cdot L4^2 \cdot L2^2 + 4 \cdot L1^2 \cdot L3^2 \cdot L2^2 + 4 \cdot L1^2 \cdot L3^2 \cdot L4^2) \right]}$
4		$r = \frac{L1^2 \cdot L2^2 \cdot L3^2 \cdot L4^2 \cdot w \cdot (L1 + L2 + L3 + L4)}{6 \left[ D \cdot (L3^2 \cdot L4^2 \cdot L2^2 + L1^2 \cdot L4^2 \cdot L2^2 + 4 \cdot L1^2 \cdot L3^2 \cdot L2^2 + L1^2 \cdot L3^2 \cdot L4^2) \right]}$
5		$r = \frac{L1^2 \cdot L2^2 \cdot L3^2 \cdot L4^2 \cdot w \cdot (L1 + L2 + L3 + L4)}{6 \left[ D \cdot (4 \cdot L3^2 \cdot L4^2 \cdot L2^2 + 4 \cdot L1^2 \cdot L4^2 \cdot L2^2 + L1^2 \cdot L3^2 \cdot L2^2 + 4 \cdot L1^2 \cdot L3^2 \cdot L4^2) \right]}$

Table 2. Displacement Matrices for Regular Plates with Central Holes

No.	Case S => Simple F => Fixed	Vertical Displacement at any point ( $r$ )
1		$r = \frac{L1^2 \cdot L3^2 \cdot L2^2 \cdot W \cdot (2 \cdot L1 + L2 + L3)}{24 \left[ D \cdot (L3^2 \cdot L2^2 + L1^2 \cdot L2^2 + L1^2 \cdot L3^2) \right]}$
2		$r = \frac{L1^2 \cdot L3^2 \cdot L2^2 \cdot W \cdot (2 \cdot L1 + L2 + L3)}{6 \left[ D \cdot (L3^2 \cdot L2^2 + L1^2 \cdot L2^2 + L1^2 \cdot L3^2) \right]}$

### CASE STUDY

In order to demonstrate the use of the simplified method and to verify the accuracy of its results, a case study was conducted. The seven plates, which are shown in Figs. 9 through 15, were selected for the study. Four of the selected plates contained holes. The plate, which is shown in Fig. 9, was analyzed for all of the boundary conditions (Table 1) while the remaining plates were only analyzed for fixed boundary conditions. Table 3 summarizes the nodal plate deflections computed using the proposed method, the computer programs SAP90

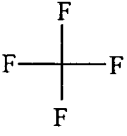
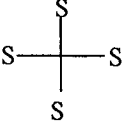
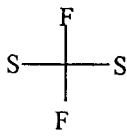
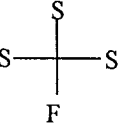
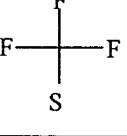
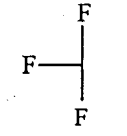
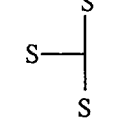
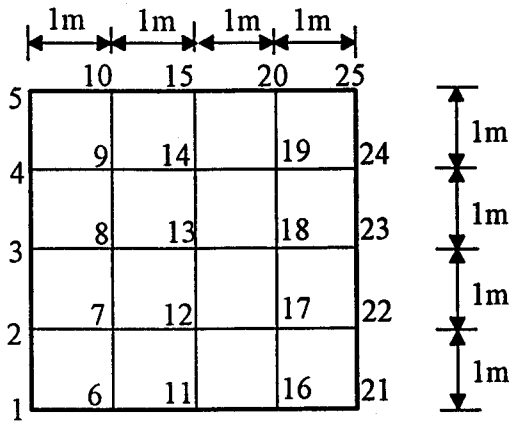

Fig. 9. Plate # 1

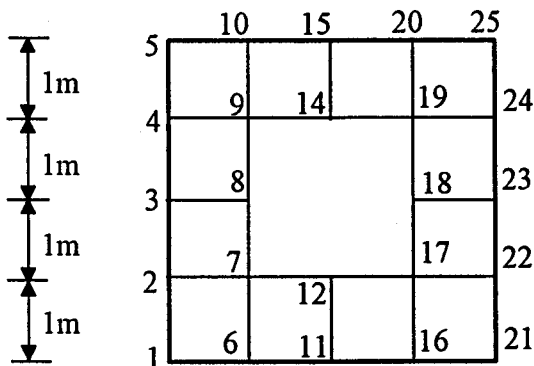

Fig. 10. Plate # 2



Simplified Method for Plate Deflection Calculation

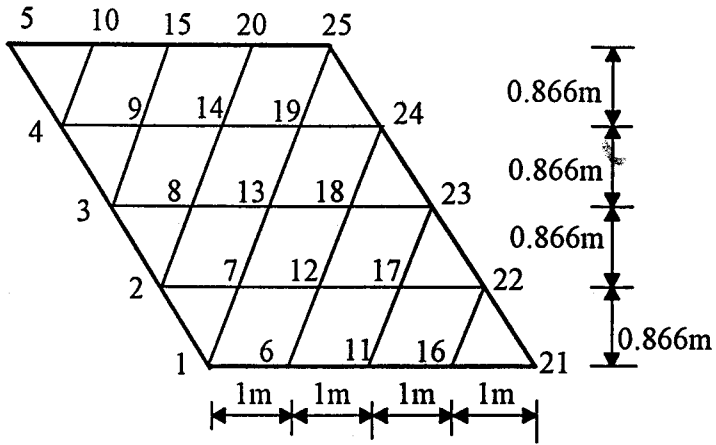

Fig. 11. Plate # 3

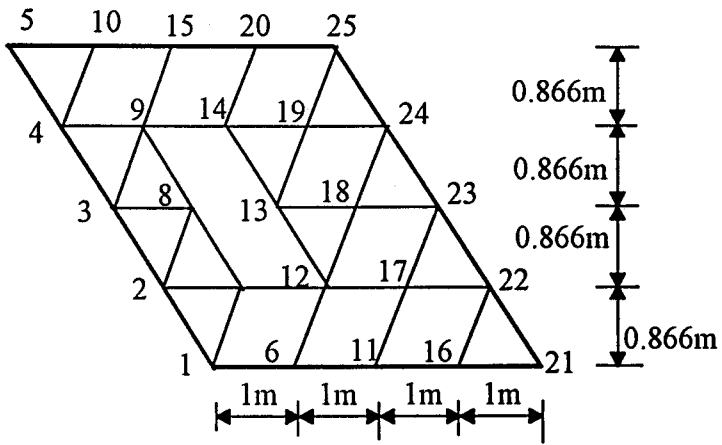

Fig. 12. Plate # 4

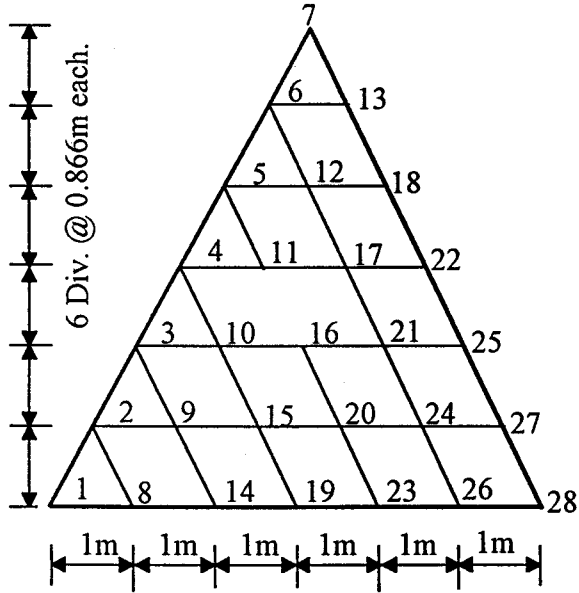

Fig. 13. Plate # 5

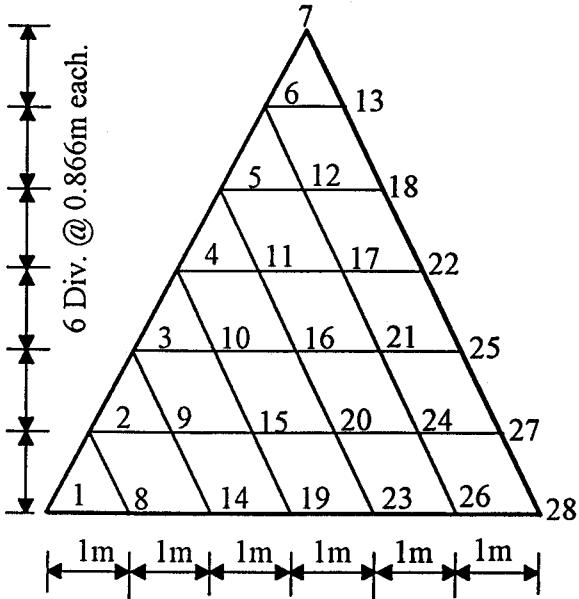

Fig. 14. Plate # 6

Table 3. Plate Nodal Deflection Results

Plate Number	Boundary Condition	Node No.	L1 (m)	L2 (m)	L3 (m)	L4 (m)	Vertical Displacement (m)			
							SPD	SAP 90	STAAD3	TIMOSHENKO
1	1	7	1.00	3.00	3.00	1.00	0.019	0.017	0.014	.....
		8	1.00	2.00	3.00	2.00	0.027	0.029	0.024	.....
		13	2.00	2.00	2.00	2.00	0.043	0.048	0.041	0.042
	2	17	3.00	3.00	1.00	1.00	0.077	0.069	0.070	.....
		18	3.00	2.00	1.00	2.00	0.106	0.096	0.097	.....
		13	2.00	2.00	2.00	2.00	0.171	0.133	0.132	0.134
	3	12	2.00	3.00	2.00	1.00	0.035	0.040	0.035	.....
		13	2.00	2.00	2.00	2.00	0.069	0.069	0.061	0.063
		17	3.00	3.00	1.00	1.00	0.031	0.029	0.027	.....
		18	3.00	2.00	1.00	2.00	0.055	0.050	0.046	.....
	4	7	1.00	3.00	3.00	1.00	0.033	0.036	0.033	.....
		8	1.00	2.00	3.00	2.00	0.073	0.069	0.067	.....
		9	1.00	1.00	3.00	3.00	0.067	0.056	0.055	.....
		13	2.00	2.00	2.00	2.00	0.098	0.096	0.090	0.092
		14	2.00	1.00	2.00	3.00	0.088	0.077	0.075	.....
	5	17	3.00	3.00	1.00	1.00	0.029	0.027	0.024	.....
		18	3.00	2.00	1.00	2.00	0.030	0.034	0.029	.....
		19	3.00	1.00	1.00	3.00	0.020	0.018	0.016	.....
		13	2.00	2.00	2.00	2.00	0.053	0.056	0.050	0.052
2	1	8	1.00	2.00	2.00	.....	0.021	0.021	0.020	.....
		14	1.00	2.00	2.00	.....	0.021	0.021	0.020	.....
		18	1.00	2.00	2.00	.....	0.021	0.021	0.020	.....
		12	1.00	2.00	2.00	.....	0.021	0.021	0.020	.....

Table 3. (Continued): Plate Nodal Deflection Results

Plate Number	Boundary Condition	Node No.	L1 (m)	L2 (m)	L3 (m)	L4 (m)	Vertical Displacement (m)			
							SPD	SAP 90	STAAD3	TIMOSHENKO
3	1	7	1.00	2.60	3.00	0.87	0.015	.....	0.016	.....
		8	1.00	1.73	3.00	1.73	0.022	.....	0.020	.....
		12	2.00	2.60	2.00	0.87	0.020	.....	0.020	.....
		13	2.00	1.73	2.00	1.73	0.034	.....	0.033	.....
		14	2.00	0.87	2.00	2.60	0.020	.....	0.020	.....
4	1	8	1.00	1.73	1.73	.....	0.018	.....	0.015	.....
		13	2.00	1.73	1.73	.....	0.044	.....	0.044	.....
5	1	11	1.73	1.00	2.00	.....	0.022	.....	0.017	.....
		16	1.73	2.00	1.00	.....	0.048	.....	0.045	.....
6	1	8	1.00	2.00	3.80	2.00	0.030		0.027	.....
		12	2.00	3.00	2.67	1.00	0.031		0.030	.....
		13	2.00	2.00	2.80	2.00	0.054		0.051	.....
		14	2.00	1.00	2.67	3.00	0.031		0.030	.....
		17	3.00	3.00	1.67	1.00	0.029		0.027	.....
19	3.00	1.00	1.67	3.00	0.029		0.027	.....		
7	1	18	1.80	2.00	2.00	.....	0.050	.....	0.053	.....

Simplified Method for Plate Deflection Calculation

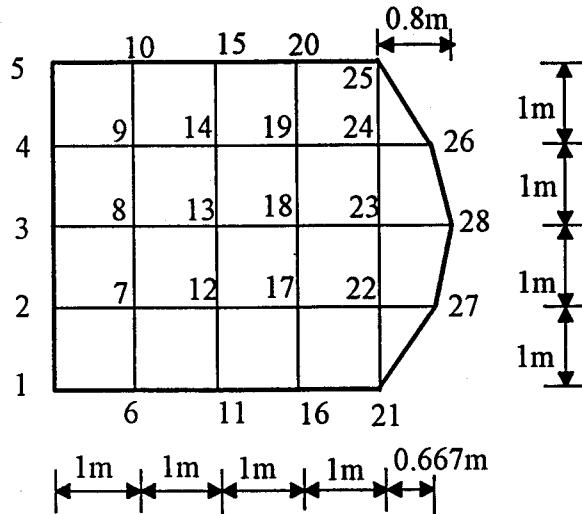

Fig. 15. Plate # 7

and STAAD3, and Timoshenko's method, respectively. Table 4 summarizes the mean absolute errors, the error standard deviations, and the maximum absolute errors between the plate deflections obtained using the proposed method and those obtained using the computer programs SAP90 and STAAD3 and Timoshenko's method. Fig. 16 summarizes the frequency distribution of the errors between the nodal deflections obtained using the proposed method and those obtained using the computer program SAP90. On the other hand, Fig. 17 summarizes the frequency distribution of the errors between the nodal deflections obtained using the proposed method and those obtained using the computer program STAAD3.

Table 4. Error Means and Standard Deviations

Analysis Method	Mean Error	Standard Method
SAP90	8.1	6.8
STAAD3	10.3	8.9
Timoshenko	8.0	9.3

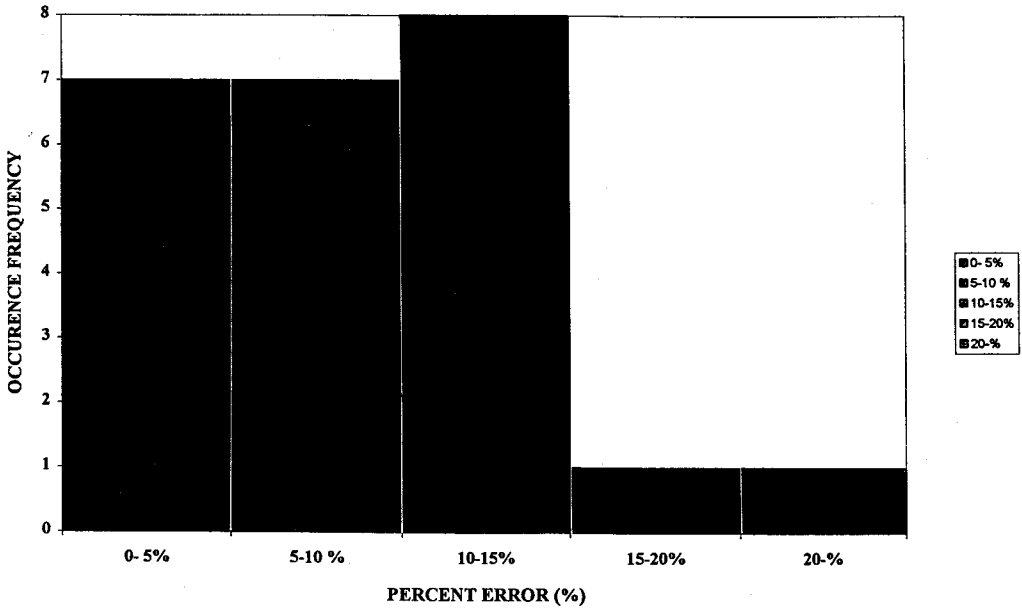

Fig. 16. Frequency distribution of errors (proposed method vs. SAP 90)

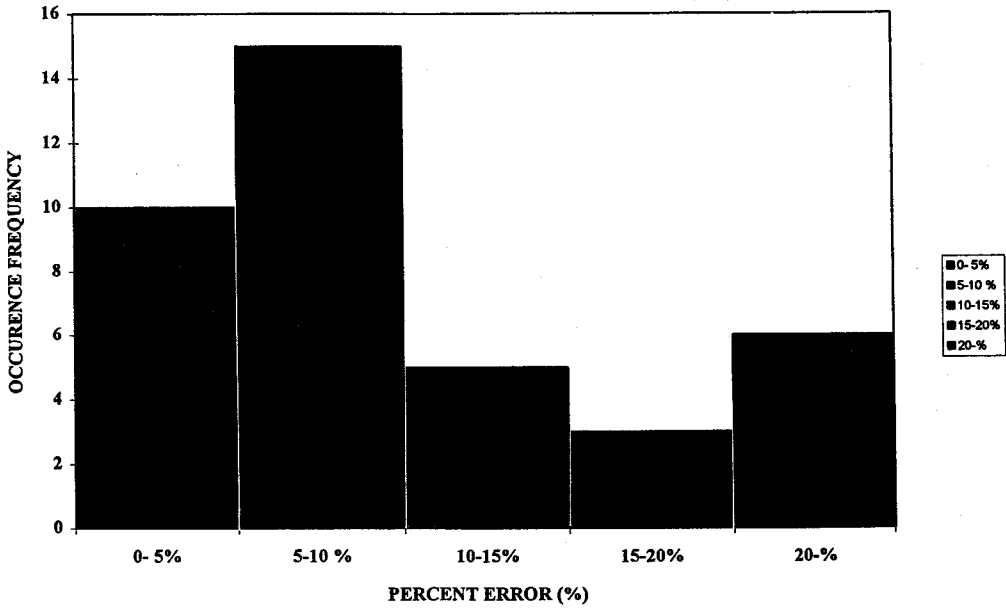

Fig. 17. Frequency distribution of errors (proposed method vs. STAAD3)

The results show that the proposed method yielded good and accurate results as compared to those obtained using the finite-element programs and as compared to those obtained analytically. The mean error and the standard deviation between the nodal deflections obtained using the proposed method and those obtained using the computer program SAP90 were equal to 8.1% and 6.8%, respectively. On the other hand, the mean error and the standard deviation between the nodal deflections obtained using the proposed method and those obtained using the computer program STAAD3 were found to be equal to 10.3% and 8.9%, respectively. Finally, the mean error and the standard deviation between the nodal deflections obtained using the proposed method and those obtained using Timoshenko's method were equal to 8.0% and 9.3%, respectively.

## PROGRAM DESCRIPTION

A computer program has been written using the mathematical package Mathcad to implement the computational procedure of the proposed method. Fig. 18 shows the sheet of the Mathcad program for a simply-supported plate. The input data for the program consists of the dimensions  $a$  and  $b$  of the plate, the intensity of the uniformly-distributed loading  $w$ , the number of divisions  $n$  in the  $y$ -axis, the number of divisions  $m$  in the  $x$ -axis, and the plate flexural rigidity  $D$ . The number of divisions  $n$  and  $m$  dictate the number of nodal points where the plate deflections are to be computed. The output of the program consists of the nodal deflection matrix  $\delta$  which includes the deflection of the plate at all nodal points.

## CONCLUSIONS

A simplified method for the calculation of plate deflections has been developed. The method, which deals with uniformly loaded plates, uses the stiffness method to obtain plate deflection equations for specified boundary conditions. The results obtained using the proposed method were in close agreement with those obtained analytically and with those obtained using the finite element methods.

The proposed method does not require mesh generation and a digital computer to solve a large stiffness matrix as in the case of the finite element method, or to solve a set of simultaneous equations as in the case of the finite

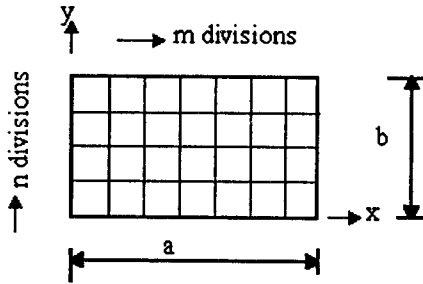

**INPUT DATA:**

- a => length in x-axis
- b => length in y-axis
- w => uniform loading
- n => # of divisions in y-axis
- m => # of divisions in x-axis
- D => flexural rigidity

**OUTPUT :**

$\delta$  => nodal deflection matrix

a := 4      b := 4      n := 4      m := 4      w := 12      D := 93.3379

L1 =  $x_i$       L2 =  $b - y_i$       L3 =  $a - x_i$       L4 =  $y_i$

i := 1..n      j := 1..m       $x_i := \frac{a}{n} \cdot i$        $y_j := \frac{b}{m} \cdot j$

**Simply Supported Boundaries:**

$$\delta_{i,j} := \frac{[(x_i)^2 \cdot (b - y_j)^2 \cdot (a - x_i)^2 \cdot (y_j)^2] \cdot w \cdot [(x_i + y_j) + (a - x_i) + (b - y_j)]}{6 \cdot [D \cdot [(a - x_i)^2 \cdot (y_j)^2 \cdot (b - y_j)^2 + (x_i)^2 \cdot (y_j)^2 \cdot (b - y_j)^2 + (a - x_i)^2 \cdot (x_i)^2 \cdot (b - y_j)^2 + (a - x_i)^2 \cdot (x_i)^2 \cdot (y_j)^2]]}$$

$$\delta = \begin{bmatrix} 0 & 0 & 0 & 0 & 0 \\ 0 & 0.077 & 0.106 & 0.077 & 0 \\ 0 & 0.106 & 0.171 & 0.106 & 0 \\ 0 & 0.077 & 0.106 & 0.077 & 0 \\ 0 & 0 & 0 & 0 & 0 \end{bmatrix}$$

**Fig. 18. MATHCAD program sheet for a simply-supported plate**

difference method. It only has one equation to determine the nodal deflection for any plate with specific boundary conditions. Locating the nodal coordinates (L1, L2, L3, and L4) and using the right deflection equation based on the plate's boundary conditions is all that one needs to determine the nodal deflection.



## REFERENCES

1. **Hsieh, Y., 1988.** Elementary Theory of Structures, Prentice-Hall, Englewood, Cliffs, New Jersey 07632, USA.
2. **SAP90, 1994.** Finite Element Program, Computers and Structures Inc., Berkeley, California 94704, USA.
3. **STAAD3, 1991.** Finite Element Program, Research Engineers Inc., Orange, California 92667, USA.
4. **Timoshenko, S. and Woinowsky, S., 1959.** Theory of Plates and Shells, McGraw-Hill Book Company, New York, USA.
5. **Ugural, A. C., 1981.** Stresses in Plates and Shells, McGraw-Hill Book Company, New York, USA.
6. **Wang, C. K., 1983.** Intermediate Structural Analysis, McGraw-Hill Book Company, New York, USA.
7. **Yang, T. Y., 1986.** Finite Element Structural Analysis, McGraw-Hill Book Company, New York, USA.