

Performance assessment of classical and fractional controllers for transient operation of gas turbine engines

Elias Tsoutsanis* Nader Meskin**

* Sheffield Hallam University, Sheffield, S1 1WB, UK
(e.tsoutsanis@shu.ac.uk).

** Qatar University, Doha, PO Box 2713, Qatar
(nader.meskin@qu.edu.qa)

Abstract: The nonlinear behaviour of gas turbine engines has motivated the development of advanced controllers for ensuring their safe and reliable operation. In this paper, the problem of controller design for a two-shaft industrial gas turbine is addressed. Specifically, a transient dynamic engine model has been developed in MATLAB/Simulink for assessing the performance behaviour of the engine. Observed engine behaviour during transient manoeuvres has enabled the development of a PI controller capable of ensuring a smooth gas turbine operation. The performance of the gas turbine engine implementing the developed PI controller has been also compared to a fractional PI controller. Results demonstrate and illustrate the remarkable impact that transient engine simulation has in the development of robust controllers.

© 2018, IFAC (International Federation of Automatic Control) Hosting by Elsevier Ltd. All rights reserved.

Keywords: Gas Turbine, MATLAB/Simulink; Engine Performance, Transient Simulation, Gas Turbine Control, PI Controller,

1. INTRODUCTION

The intermittent nature of renewable energy sources encourages the gas turbines to operate with increased flexibility for supporting their renewable plant partners and maintaining the stability of the electricity grid, as demonstrated by Barelli et al. (2017); di Gaeta et al. (2017). Fast start-up, shut-down, load-following modes, and part-load operation, as examined by Bahlawan et al. (2017), are dominating the operating regime of today's gas turbines. Understanding the behaviour of these engines under such demanding operating conditions is crucial for their successful operation and maintenance (O&M), see Tsoutsanis et al. (2017). For the above purposes, the engine manufacturers invest a significant amount of their resources and human capital exclusively for modelling, monitoring, and analysing the performance of power plants, as reviewed by Tahan et al. (2017).

Gas turbine engine models have a pivotal role in today's digital platform, since their simulations aid the development of engine controllers, see Ponce et al. (2016), and the optimisation of operating schedules. Recently, studies that explore the dynamic simulation aspect of gas turbines, such as Alobaid et al. (2017), have gained considerable attention.

The reason for this transition lies in the fact that dynamic engine models are capable of assessing the behaviour of an engine for a wide range of operating conditions including transient operation. In addition, dynamic models enable novel diagnostics, see Tsoutsanis et al. (2014, 2015); Amozegar and Khorasani (2016); Ceschini et al. (2018), and prognostics solutions, as presented in Tsoutsanis et al.

(2016); Tsoutsanis and Meskin (2017), which indeed improve the O&M of gas turbines. Therefore, the recently transformed gas turbine operating profile has motivated the development of robust, modular, flexible, and accurate engine models that can facilitate the performance analysis of gas turbines in real-time conditions. Moreover, the observed engine model behaviour at transient operating conditions has the potential to aid the design of engine controllers that will enable modern gas turbines to fulfil their role in this dynamic and flexible operating environment.

In this paper, a dynamic engine model of a gas turbine engine developed in MATLAB/Simulink environment by the authors Tsoutsanis et al. (2016), is used in the design of an engine controller. The engine model implements a family of component performance maps, as look up tables, and is represented by a set of first order differential equations which are added to the steady state component matching thermodynamic equations. The transient performance simulations highlighted some key issues that might be hazardous for a real gas turbine. This prompted the development of an engine controller for enabling smooth and safe engine operation. Among a variety of classical controllers, the most common type of controller used for gas turbine engines is the proportional and integral (PI) controller.

Recently, alternatives to the classical controllers, called fractional controllers, have gained significant attention Shah and Agashe (2016); Podlubny (1998); Petras (2011); Machado et al. (2011). Their fractional calculus nature provides additional degrees of freedom, in comparison to classical controllers, and therefore have the potential to

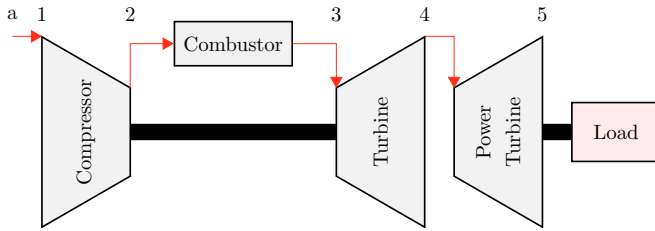

Fig. 1. The engine model schematic layout representing a two shaft gas turbine.

provide a more robust alternative to the classical controllers. However, there are limited number of studies of fractional controllers used for energy systems, see Sondhi and Hote (2014, 2016), and even less on gas turbines engines, see Jadhav et al. (2014). This motivated the development of a fractional controller for a gas turbine engine. In this study, we implement both a fractional and classical PI controller, and under dynamic operating conditions, we assess and compare their respective performance. In contrary to Jadhav et al. (2014), where the gas turbine is represented by a simple Rowen's model, see Rowen (1983), and the fractional controller is based on the Bode's ideal loop transfer function, in this study we implement an advanced component-based thermodynamic model, that utilises component performance maps, and a simpler fractional controller, developed in MATLAB/Simulink environment by Tepljakov et al. (2011). This simulated study gives additional insights of the engine dynamic behaviour that has the potential to serve as a useful guide for designing and optimising of engine controllers suitable for transient engine operation.

2. METHODOLOGY

2.1 Gas Turbine Model

For this study, an engine model of a two-shaft industrial gas turbine is developed in MATLAB/Simulink. The system consists of a gas generator and a free power turbine. The main components of the gas generator are the compressor, the combustor, and the turbine. The exhaust gases of the gas generator are driving the power turbine which is coupled to an electricity generator as seen from Fig. 1.

The following notation is used throughout the paper. Temperature and pressure are denoted by T_i and P_i , respectively where subscript $i = a, 1, 2, 3, 4, 5$ represents the engine station. For the transient performance analysis, a dynamic engine model has been developed in Simulink based on the Inter-Component Volume (ICV) method. For a detailed description of the model the reader is prompted to Tsoutsanis et al. (2013). The ICV method assumes the existence of mass flow imbalances during the dynamic operation. For implementing this method, two plenum volumes are integrated in the engine model as seen from Fig. 2.

As far as the plenum volumes are concerned, one is placed between the compressor and the turbine, and the other between the turbine and the power turbine. These volumes are introduced for taking into account all the flow imbalances given that in transient operating conditions only the flow compatibility is satisfied. The mass flow

imbalances initiated by the fuel addition in the combustor are utilised for evaluating the rate by which pressure increases. A description of the engine dynamics follows in the next paragraphs.

A simplified version of the law of continuity of mass is commonly used to describe the pressure rise within the combustor:

$$\frac{dP_2}{dt} = \frac{RT_2}{V_1}(\dot{m}_1 + \dot{m}_f - \dot{m}_3), \quad (1)$$

where R , V_1 , and P_2 denote the gas constant (287 J/kg), the combustor volume, and the compressor delivery pressure, respectively. The air mass flow rate entering the combustor and the fuel flow rate are denoted by \dot{m}_1 and \dot{m}_3 , respectively. The combustor outlet pressure can be calculated as a simple proportionality from:

$$\frac{P_2 - P_3}{P_2} = PLF, \quad (2)$$

where PLF is the combustor pressure loss factor and for this study a 5% drop in pressure is assumed. A similar set of equations has been used for the duct volume between the turbine and the power turbine, such as:

$$\frac{dP_4}{dt} = \frac{RT_4}{V_2}(\dot{m}_3 - \dot{m}_4), \quad (3)$$

where V_2 and P_4 denote the duct volume and the turbine delivery pressure, respectively. The mass flow rate entering the power turbine is denoted by \dot{m}_4 .

Due to the fact that only flow compatibility is satisfied during transient conditions, the difference between the work consumed by the compressor W_c and the work extracted by the turbine W_t is utilised to compute the acceleration of the engine as follows:

$$\frac{dN}{dt} = \left(\frac{30}{\pi}\right)^2 \cdot \frac{W_t - W_c}{JN}, \quad (4)$$

where J denotes the shaft polar moment of inertia measured in kg m^2 and N denotes the gas turbine's shaft speed measured in rpm.

2.2 System States

Let us assume that the set of variables which govern the dynamics of the system is denoted by x and the vector input that changes the system's state is denoted by u . For the dynamic engine model, the compressor and turbine exit pressures P_2 and P_4 can be considered as the states of the systems which are critical. If all the isentropic efficiencies and temperatures of the gas turbine components are determined, then the engine gas path pressures can be computed from the thermodynamic equations. The shaft rotational speed N of the gas turbine is another critical state of the system. The fuel flow rate \dot{m}_f is implemented for controlling the system's state. Thus, the state and control variables are defined as follows

$$x = [P_2, P_4, N]^T, \quad (5)$$

$$u = \dot{m}_f. \quad (6)$$

The gas path pressures along with the shaft rotational speed of the steady state conditions serve as initial condi-

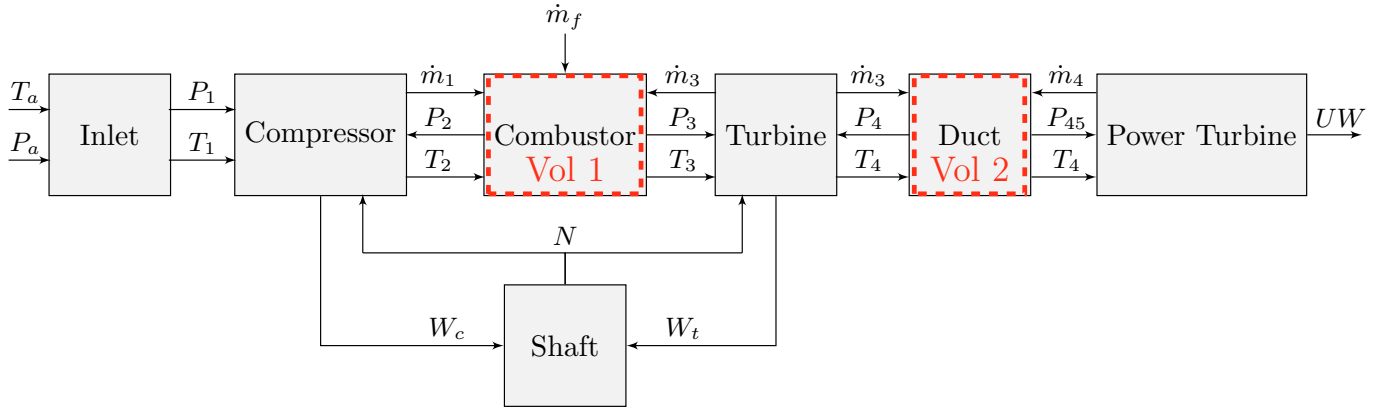

Fig. 2. Schematic representation of the modular computational interaction of the transient engine model.

tions of the dynamic engine model. To summarise, the gas turbine dynamics may be expressed as:

$$\frac{dx}{dt} = f(x, u). \tag{7}$$

During steady state operation, all the derivatives dP_2/dt , dP_4/dt and dN/dt are equal to zero. As long as the fuel flow supplied to the engine is not lying within the steady state operating line, the work consumed by the compressor will not be matched by the work extracted by the turbine. The engine will react to this unbalanced work by increasing/decreasing its shaft rotational speed according to the fuel flow command.

2.3 PI Controller

Depending of the fuel flow command, the engine might be forced to operate in unfavourable conditions. Especially when there are sudden changes in the demanded shaft rotational speed, this could lead to violation of the engine firing temperature limits and even to compressor surge. This motivates the development of a suitable controller for ensuring that the fuel flow command will guarantee a safe and reliable operation of the engine.

Numerous control methods and controllers are available for gas turbine engines but for this study we implement a simple PI controller to demonstrate its effectiveness. The PI controller is one of the most common controllers used in gas turbines and its objective is to regulate the fuel flow \dot{m}_f according to the actuating signal ε arising from the comparison of the desired N_d and the measured N_m shaft rotational speed of the engine. One of the prerequisites for the design of a controller is to represent the behaviour of the fuel flow actuator system and the speed measurement sensor. For the above purpose the fuel flow actuator system and the speed sensor are both represented by first order transfer functions that are typical for these systems, see Camporeale et al. (2006); Wang et al. (2017).

The first transfer function acts on the input signal of fuel flow rate and the second one acts on the shaft rotational speed. The initial conditions of the transfer functions correspond to the mass flow rate and the shaft rotational speed at design point conditions. The PI controller receives the N_m signal and calculates the required fuel flow rate \dot{m}_{f_d} using the PI control schedule. The demand of \dot{m}_{f_d}

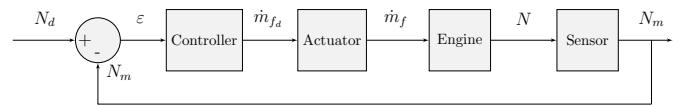

Fig. 3. Block diagram of a speed controller for fuel flow regulation.

is then turned into the actual fuel flow \dot{m}_f injected into the engine combustor to maintain the engine operation. A schematic diagram of this arrangement can be seen from Fig. 3.

The control function of this PI controller can be expressed as follows:

$$C(s) = \frac{\dot{m}_{f_d}(s)}{\varepsilon(s)} = K_p + \frac{K_i}{s} \tag{8}$$

where K_p and K_i denote the coefficients of the proportional and the integral terms, respectively. In the time domain this control function is given by:

$$\dot{m}_{f_d}(t) = K_p \varepsilon(t) + K_i \int_0^t \varepsilon(t) dt \tag{9}$$

where $\varepsilon(t) = N_d(t) - N_m(t)$. The transfer functions for a typical fuel system actuator and the speed sensor are assumed, according to Camporeale et al. (2006); MacIsaac and Langton (2011), to be as follows:

$$G_1(s) = \frac{\dot{m}_f(s)}{\dot{m}_{f_d}(s)} = \frac{1}{0.05s + 1} \tag{10}$$

$$G_2(s) = \frac{N_m(s)}{N(s)} = \frac{1}{0.05s + 1} \tag{11}$$

These simple first order lag equations are adequate for satisfying the objective of this analysis which is to demonstrate the effectiveness of a controller on the engine transient behaviour. However, if a more detailed simulation approach for the fuel flow system dynamics is sought, then the reader is prompted to Wang et al. (2017). Based on the observations of the engine model behaviour at transient conditions we have developed a PI controller and tuned accordingly its coefficients K_p and K_i in order to obtain smooth operation of the engine model. The implementation of such a controller ensures smooth acceleration and deceleration of the engine.

2.4 Fractional PI^λ Controller

A fractional PI^λ controller is an extension of the classical PI controller. The transfer function of this PI^λ controller can be expressed as follows:

$$C(s) = \frac{\dot{m}_{fd}(s)}{\varepsilon(s)} = K_p + \frac{K_i}{s^\lambda} \quad (12)$$

which involves an integrator of order λ . If $\lambda = 1$ we obtain a classical PI controller.

For this study the FOMCON MATLAB toolbox developed by Teplicakovic et al. (2011) is implemented. This toolbox provides Simulink blocks for fractional PID controllers, fractional transfer functions etc. The toolbox is available for download from <http://fomcon.net/fomcon-toolbox/download/>

3. RESULTS

3.1 Case Study 1: Transient Step Response without a Controller

The objective of case study 1 is to analyse the engine model performance for step fuel flow commands. The engine model arrangement for this case study represents an open-loop control system since there is no controller implementation. For this case study the fuel flow, shown in Fig. 4, commences at time instant $t=0$ seconds from its steady state condition until it reaches the time instant $t=3$ seconds. At $t=3$ s a step input is utilised to instantly decrease the fuel flow to 70% of its design point value. The fuel flow command will be maintained at this level for another 4 seconds until $t=7$ s where it will step back to its original steady state condition for the remaining simulation.

The assessment of the engine performance during fast step responses provides useful insights about the operating and surge limits of the engine that could subsequently facilitate the development of a controller. A close examination of the measured parameters shown in Fig. 4 proves that the response of the engine to this step command results in sudden temperature changes to the hot end of the engine. These are reflected by the temperatures at the power turbine exit T_5 .

In practice, unregulated fuel flow commands such as these might prove catastrophic for the engine since they might violate its firing temperature limits. These types of observations and insights promote the importance of the transient performance analysis of an engine. It can be concluded that fast and accurate preliminary model-based evaluation of the transient engine behaviour has the prospect of saving costs by avoiding tests that might lead to engine failure and more importantly to facilitate the design of controllers for establishing the safe operating limits of a complex and highly nonlinear system.

3.2 Case Study 2: Transient Step Response with PI Controller

The objective of this case study is to assess the effect of a simple PI controller under transient conditions. Specifically, a PI controller is used to regulate the fuel flow

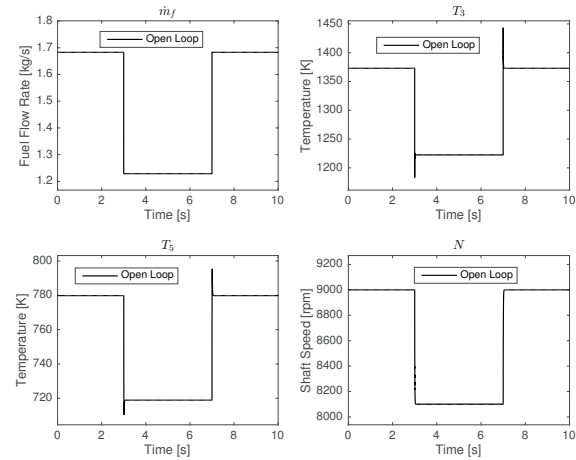

Fig. 4. The simulated parameters of the dynamic engine model with respect to time for a step fuel flow command.

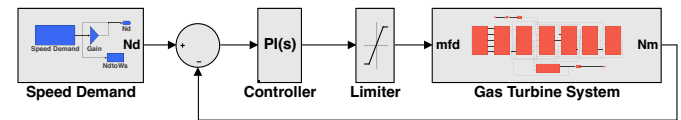

Fig. 5. Schematic layout of the MATLAB/Simulink model with PI controller.

and ensure a smooth acceleration and deceleration of the engine. The schematic diagram of this control arrangement is shown in Fig. 5.

The PI controller modifies the fuel flow based on the difference between the measured N_m and demanded N_d shaft speed of the engine. The lower and upper limit values of the limiter block are 0 and 1.2, respectively. The coefficients K_p and K_i of the controller have been tuned from the built-in tuning function of Simulink. In this environment, the user has the capability to observe the initial response of the engine block. Moreover, the visual representation of the system's tuned response enables the user to properly identify the desired transient response characteristics of the engine. This process results in a set of tuned coefficients that subsequently update the PI controller used in Simulink model. For this Case Study, the coefficients of the PI controller and the transient response characteristics are summarised in Table 1.

Table 1. The parameters of the PI controller.

| Parameter | Value | Units |
|---------------|-----------|---------|
| K_p | 4.857E-05 | - |
| K_i | 3.570E-03 | - |
| Rise time | 0.19 | seconds |
| Settling time | 0.345 | seconds |
| Overshoot | 0 | % |
| Peak | 1 | - |

It becomes clear from Fig. 6 that the T_5 is no longer exhibiting an oscillating behaviour during this sudden increase in the demanded engine speed since the fuel flow has been modified through the PI controller. The implemented controller has resolved the previous issues of Case Study 1 by regulating a fuel flow rate that results in a smoother engine operating profile.

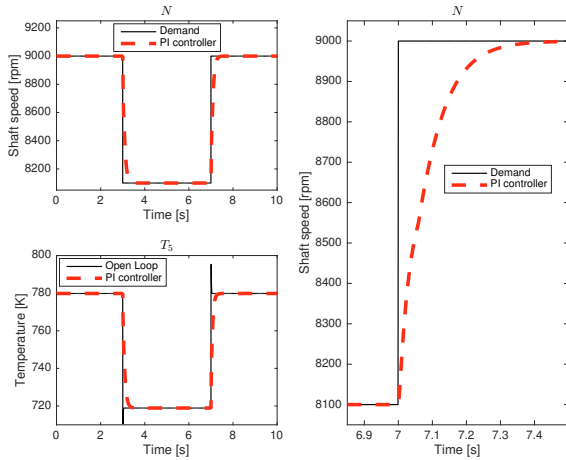

Fig. 6. Variation of the simulated measurements with respect to time from MATLAB/Simulink model of Case Study 2.

3.3 Case Study 3: Transient Step Response with fractional PI^λ Controller

The objective of this case study is to assess the effect of a fractional order PI controller under transient conditions. The fractional PI controller is having the same objective with the classical PI controller of Case Study 2.

A fractional order PI controller from the FOMCON toolbox replaced the previous classical PI controller. The coefficients K_p and K_i and the λ have been modified to achieve a smooth engine operation. For this Case Study, the coefficients of the PI^λ controller and the transient response characteristics are summarised in Table 2.

Table 2. The parameters of the PI^λ controller.

| Parameter | Value | Units |
|---------------|----------|---------|
| K_p | 4.85E-05 | - |
| K_i | 0.0214 | - |
| λ | 0.9 | - |
| Rise time | 0.026 | seconds |
| Settling time | 0.052 | seconds |
| Overshoot | 0 | % |
| Peak | 1 | - |

It becomes clear from Fig. 7 that the speed demand N_d is satisfied faster than the classical PI controller. It is noticed that during the initialisation stage there is a large fluctuation of the simulated parameters. The reason for this problem is due to the fact that the FOMCON toolbox is currently not providing the user with the option of setting up the initial conditions of a fractional controller. A closer look at the Fig. 7 reveals that the power turbine exit temperature T_5 exhibits a small fluctuation in the final stages of the step commands.

A comparison between the classical and fractional order PI controllers is shown in Fig. 8. It is evident that while the speed demand N_d is accurately matched by implementing a fractional PI^λ controller, it still exhibits a small oscillation for the power turbine exit temperature T_5 .

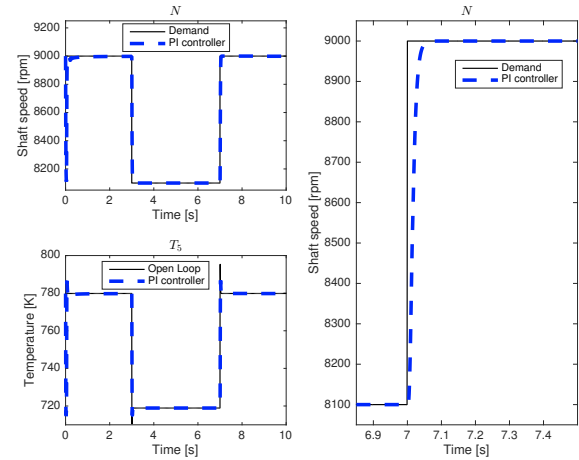

Fig. 7. Variation of the simulated measurements with respect to time from MATLAB/Simulink model of Case Study 3.

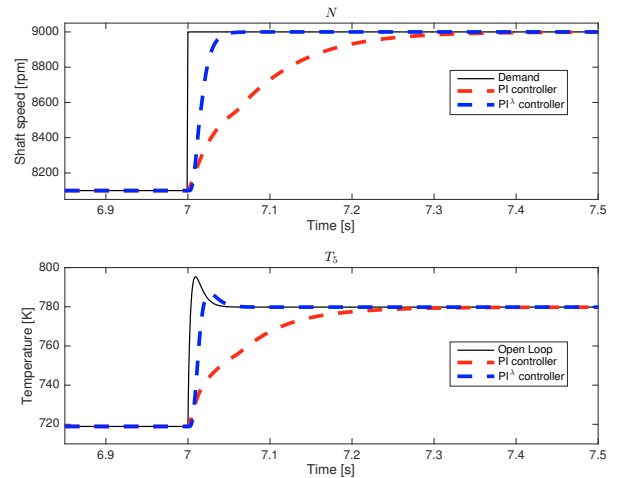

Fig. 8. Variation of the simulated measurements with respect to time from MATLAB/Simulink models of Case Studies 2 and 3.

In terms of computation time, the model that utilised the fractional controller is slightly slower in comparison with the model that uses the classical controller, as summarised in Table 3.

Table 3. Computation time of MATLAB/Simulink models.

| Model | Computation time | Units |
|--------------|------------------|---------|
| PI | 1.66 | seconds |
| PI^λ | 1.74 | seconds |

Finally, it can be said that while the classical controllers tuning process is very well supported in the Simulink environment, the same is not applicable for fractional order controllers.

4. CONCLUSION

The problem of controller design for transient gas turbine engine operation has been addressed in this paper.

A dynamic engine model has been used to evaluate and compare classical and fractional order controllers. The engine model has been developed in MATLAB/Simulink environment. Three engine simulation scenarios have been carried out by using the classical PI controller available from Simulink and a fractional PI controller available from FOMCON toolbox. The results demonstrated the potential that fractional controllers have over their classical counterparts in terms of performance and robustness. For a typical transient manoeuvre of a gas turbine engine the fractional PI controller is faster and more accurate than a classical PI controller. However, these types of controllers present several challenges for their implementation. Tuning and optimising the coefficients of such controllers stills remains a challenging topic that has to be properly addressed by the scientific community.

REFERENCES

- Alobaid, F., Mertens, N., Starkloff, R., Lanz, T., Heinze, C., and Epple, B. (2017). Progress in dynamic simulation of thermal power plants. *Progress in Energy and Combustion Science*, 59, 79–162.
- Amozegar, M. and Khorasani, K. (2016). An ensemble of dynamic neural network identifiers for fault detection and isolation of gas turbine engines. *Neural Networks*, 76, 106–121.
- Bahlawan, H., Morini, M., Pinelli, M., Spina, P.R., and Venturini, M. (2017). Development of reliable narx models of gas turbine cold, warm and hot start-up. In *ASME Turbo Expo 2017: Turbomachinery Technical Conference and Exposition*, V009T27A007–V009T27A007. American Society of Mechanical Engineers.
- Barelli, L., Bidini, G., and Ottaviano, A. (2017). Integration of sofc/gt hybrid systems in micro-grids. *Energy*, 118, 716–728.
- Camporeale, S., Fortunato, B., and Mastrovito, M. (2006). A modular code for real time dynamic simulation of gas turbines in simulink. *Journal of Engineering for Gas Turbines and Power*, 128(3), 506–517.
- Ceschini, G.F., Venturini, M., Hubauer, T., Murarasu, A., et al. (2018). Optimization of statistical methodologies for anomaly detection in gas turbine dynamic time series. *Journal of Engineering for Gas Turbines and Power*, 140(3), 032401–10.
- di Gaeta, A., Reale, F., Chiariello, F., and Massoli, P. (2017). A dynamic model of a 100 kw micro gas turbine fuelled with natural gas and hydrogen blends and its application in a hybrid energy grid. *Energy*, 129, 299–320.
- Jadhav, S.P., Hamde, S.T., et al. (2014). Robust fractional-order controller for power plant gas turbine. *International Journal of Computer Applications*, 88(16).
- Machado, J.T., Kiryakova, V., and Mainardi, F. (2011). Recent history of fractional calculus. *Communications in Nonlinear Science and Numerical Simulation*, 16(3), 1140–1153.
- MacIsaac, B. and Langton, R. (2011). *Gas turbine propulsion systems*, volume 49. John Wiley & Sons.
- Petras, I. (2011). *Fractional-order nonlinear systems: modeling, analysis and simulation*. Springer Science & Business Media.
- Podlubny, I. (1998). *Fractional differential equations: an introduction to fractional derivatives, fractional differential equations, to methods of their solution and some of their applications*, volume 198. Elsevier.
- Ponce, C.V., Sáez, D., Bordons, C., and Núñez, A. (2016). Dynamic simulator and model predictive control of an integrated solar combined cycle plant. *Energy*, 109, 974–986.
- Rowen, W.I. (1983). Simplified mathematical representations of heavy-duty gas turbines. *Journal of Engineering for Power*, 105(4), 865–869.
- Shah, P. and Agashe, S. (2016). Review of fractional pid controller. *Mechatronics*, 38, 29–41.
- Sondhi, S. and Hote, Y.V. (2014). Fractional order pid controller for load frequency control. *Energy Conversion and Management*, 85, 343–353.
- Sondhi, S. and Hote, Y.V. (2016). Fractional order pid controller for perturbed load frequency control using kharitonovs theorem. *International Journal of Electrical Power & Energy Systems*, 78, 884–896.
- Tahan, M., Tsoutsanis, E., Muhammad, M., and Karim, Z.A. (2017). Performance-based health monitoring, diagnostics and prognostics for condition-based maintenance of gas turbines: A review. *Applied Energy*, 198, 122–144.
- Tepljakov, A., Petlenkov, E., and Belikov, J. (2011). Fomcon: Fractional-order modeling and control toolbox for matlab. In *Mixed Design of Integrated Circuits and Systems (MIXDES), 2011 Proceedings of the 18th International Conference*, 684–689. IEEE.
- Tsoutsanis, E., Li, Y.G., Pilidis, P., and Newby, M. (2017). Non-linear model calibration for off-design performance prediction of gas turbines with experimental data. *The Aeronautical Journal*, 121(1245), 1758–1777.
- Tsoutsanis, E. and Meskin, N. (2017). Derivative-driven window-based regression method for gas turbine performance prognostics. *Energy*, 128, 302–311.
- Tsoutsanis, E., Meskin, N., Benammar, M., and Khorasani, K. (2013). Dynamic performance simulation of an aeroderivative gas turbine using the matlab simulink environment. In *ASME 2013 International Mechanical Engineering Congress and Exposition*, V04AT04A050–V04AT04A050. American Society of Mechanical Engineers.
- Tsoutsanis, E., Meskin, N., Benammar, M., and Khorasani, K. (2014). A component map tuning method for performance prediction and diagnostics of gas turbine compressors. *Applied Energy*, 135, 572–585.
- Tsoutsanis, E., Meskin, N., Benammar, M., and Khorasani, K. (2015). Transient gas turbine performance diagnostics through nonlinear adaptation of compressor and turbine maps. *Journal of Engineering for Gas Turbines and Power*, 137(9), 091201–091201–12.
- Tsoutsanis, E., Meskin, N., Benammar, M., and Khorasani, K. (2016). A dynamic prognosis scheme for flexible operation of gas turbines. *Applied Energy*, 164, 686–701.
- Wang, C., Li, Y., and Yang, B. (2017). Transient performance simulation of aircraft engine integrated with fuel and control systems. *Applied Thermal Engineering*, 114, 1029–1037.