

Graduate Students
Energy, Environment, &
Resource Sustainability

Abathar Abdulkarim Al-Hamrani, M.Sc.

Supervisor: Wael Alnahhal, Ph. D.

Department of Civil & Architectural Engineering, Qatar University

ABSTRACT

This poster presents a comprehensive experimental and analytical study to investigate the shear performance and ultimate capacity of fiber reinforced concrete (FRC) beams reinforced with Basalt Fiber Reinforced plastic (BFRP) bars and Glass Fiber reinforced plastic (GFRP) stirrups.

A total of 14 concrete beam specimens were tested under four-point loading until failure. The parameters investigated included the reinforcement ratio ($2\rho_b$, $3.1\rho_b$, and $4.53\rho_b$), the span to depth ratio ($a/d=2.5$, and $a/d=3.3$), the spacing between stirrups ($S1=170\text{mm}$, and $S2=250\text{mm}$) and the basalt fiber volume fraction (0%, 0.75% and 1.5%).

Test results clearly showed that both BFRP bars and basalt macro-fiber can be used as sustainable and eco-friendly alternative materials in Concrete Structures in Qatar.



BFRP Bars



Basalt Macro-Fibers



Glass FRP stirrup



Concrete Beams after Casting

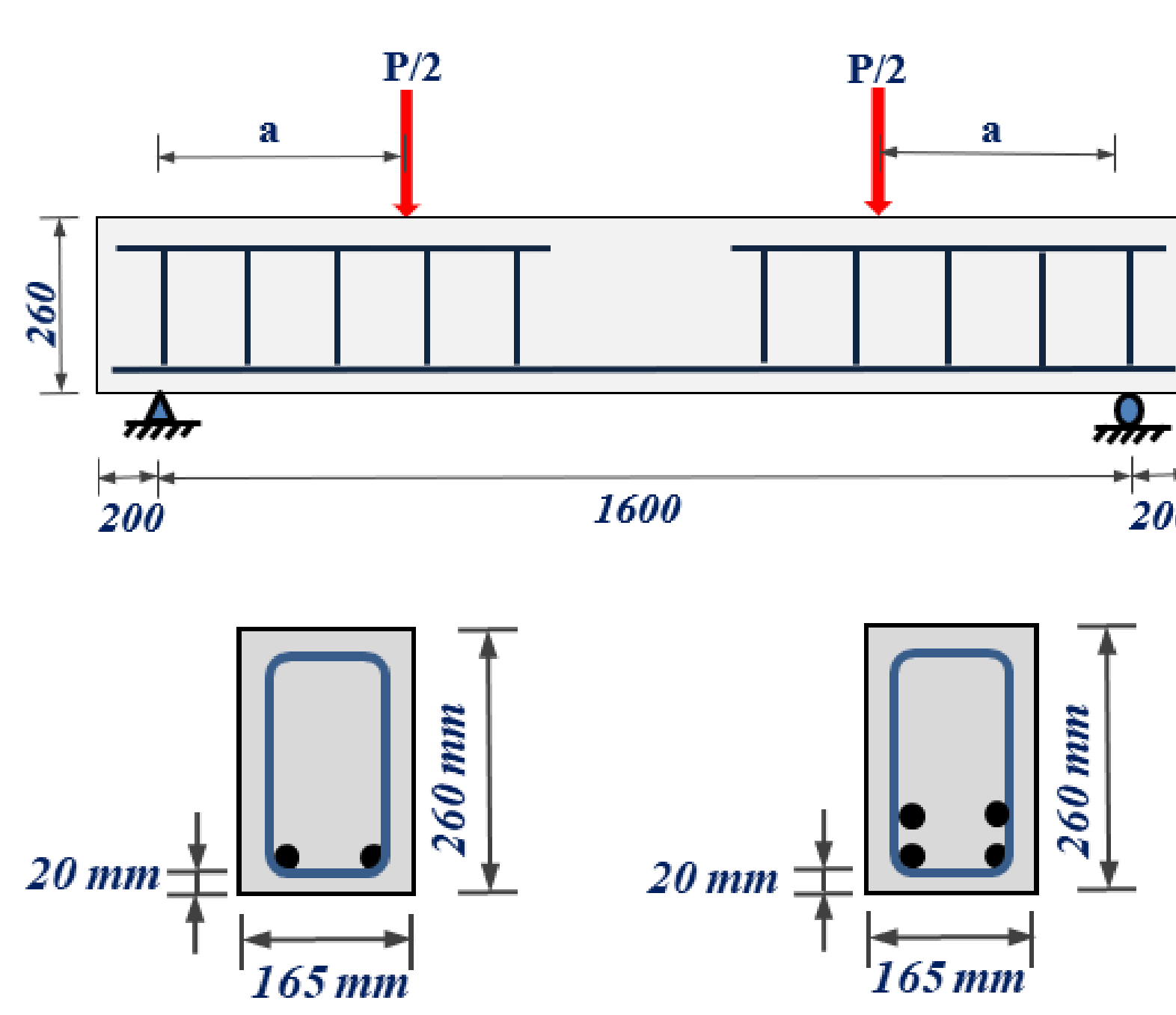

Full-Scale Beam Test Set-up

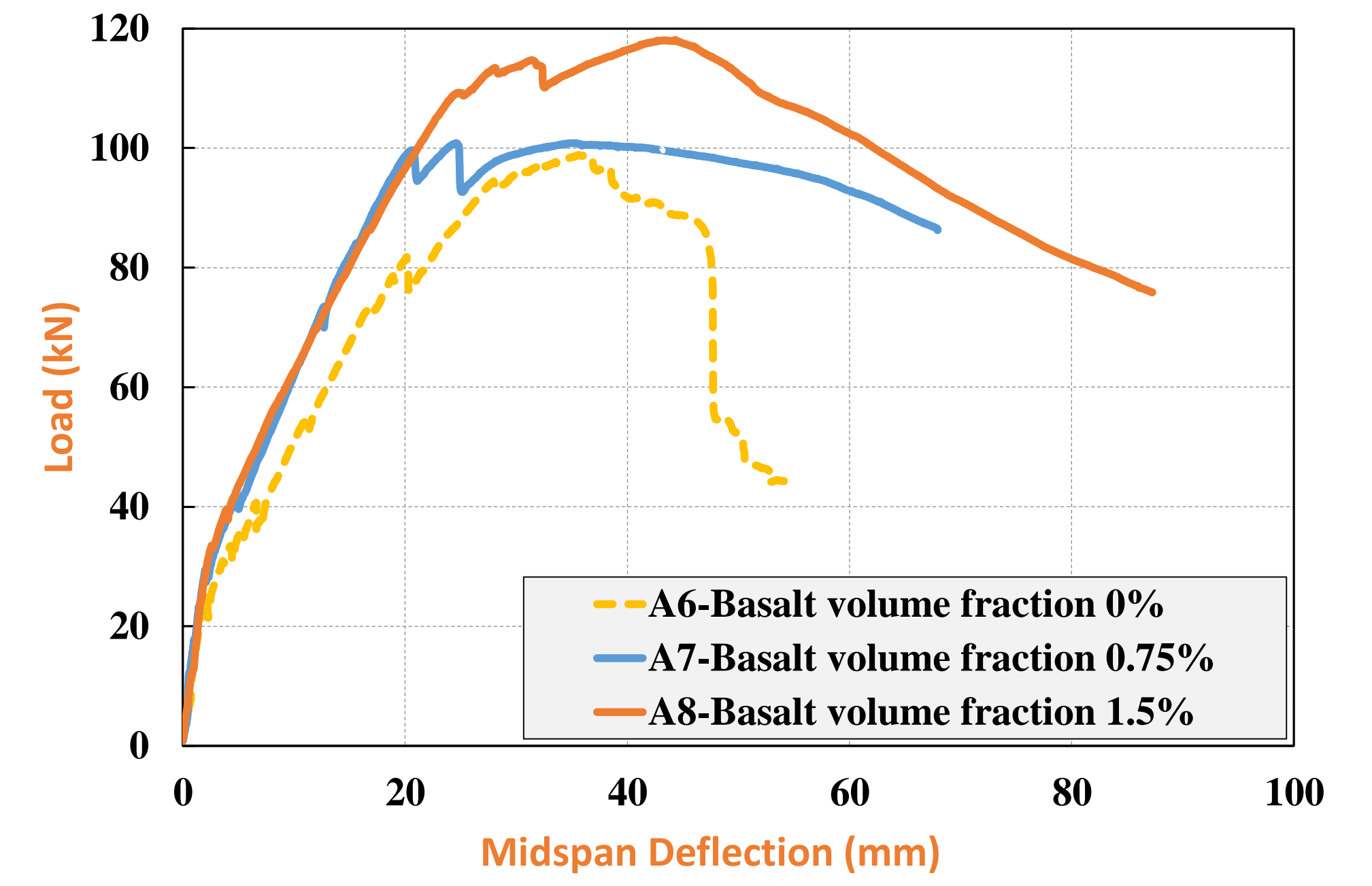

Effect of Fiber Volume Fraction Ratio

FIBERS EFFECT ON FAILURE MODE

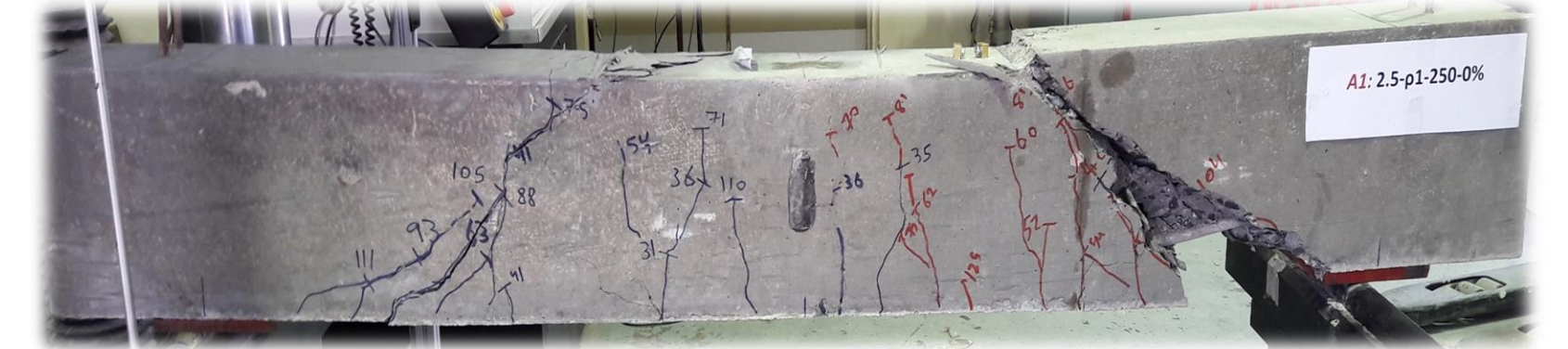

Beam with 0% of fibers (Diagonal tension shear failure with concrete spallation)

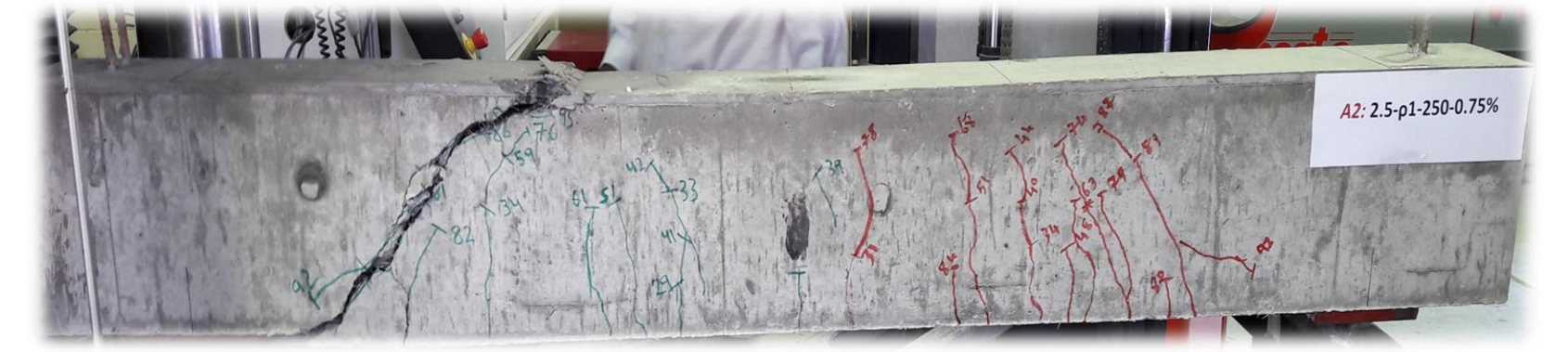

Beam with 0.75% of fibers (Diagonal tension shear failure without concrete spallation)



Beam with 1.5% of fibers (Compression flexural failure without concrete spallation)

RESULTS

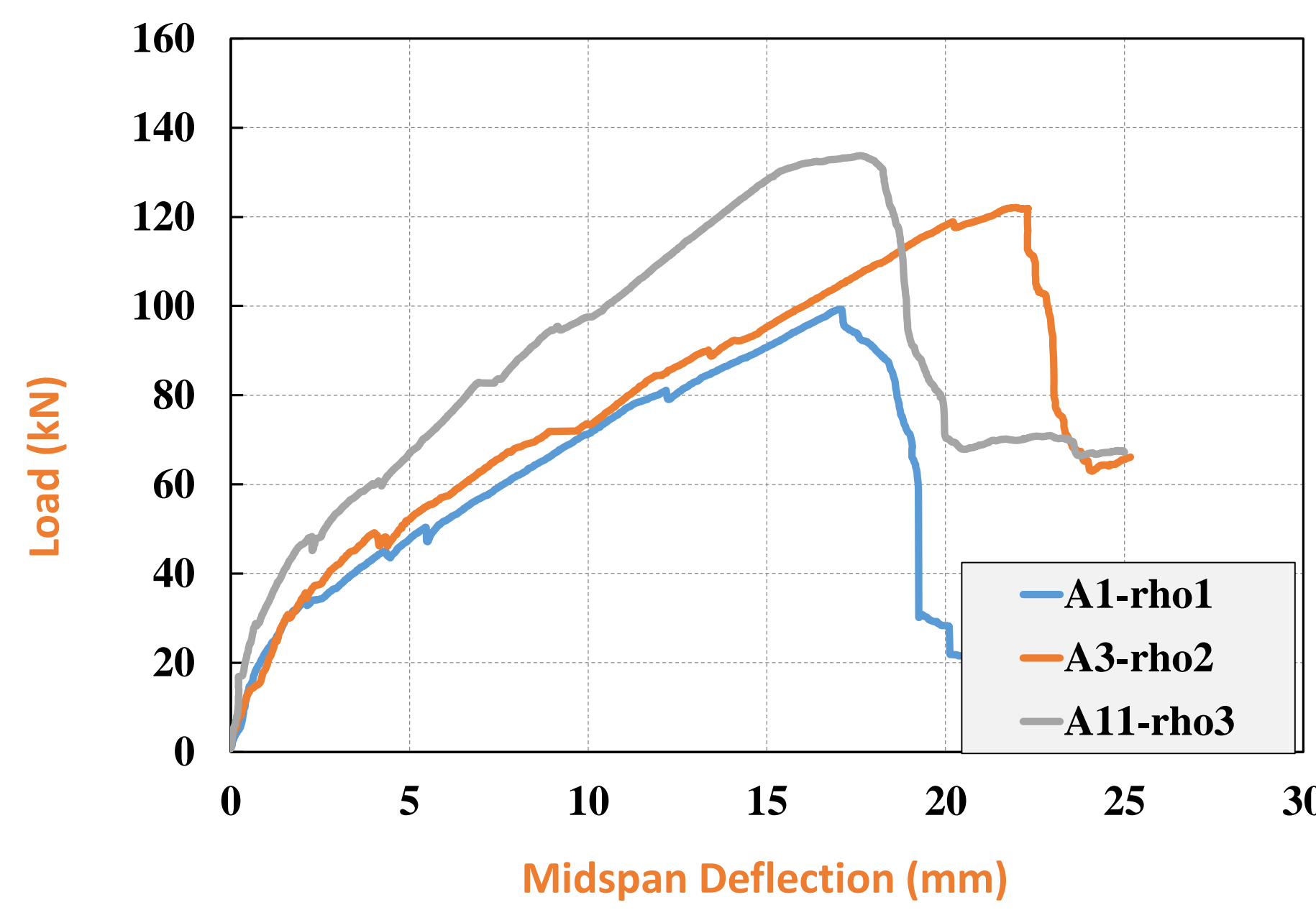

Effect of Main Reinforcement Ratio

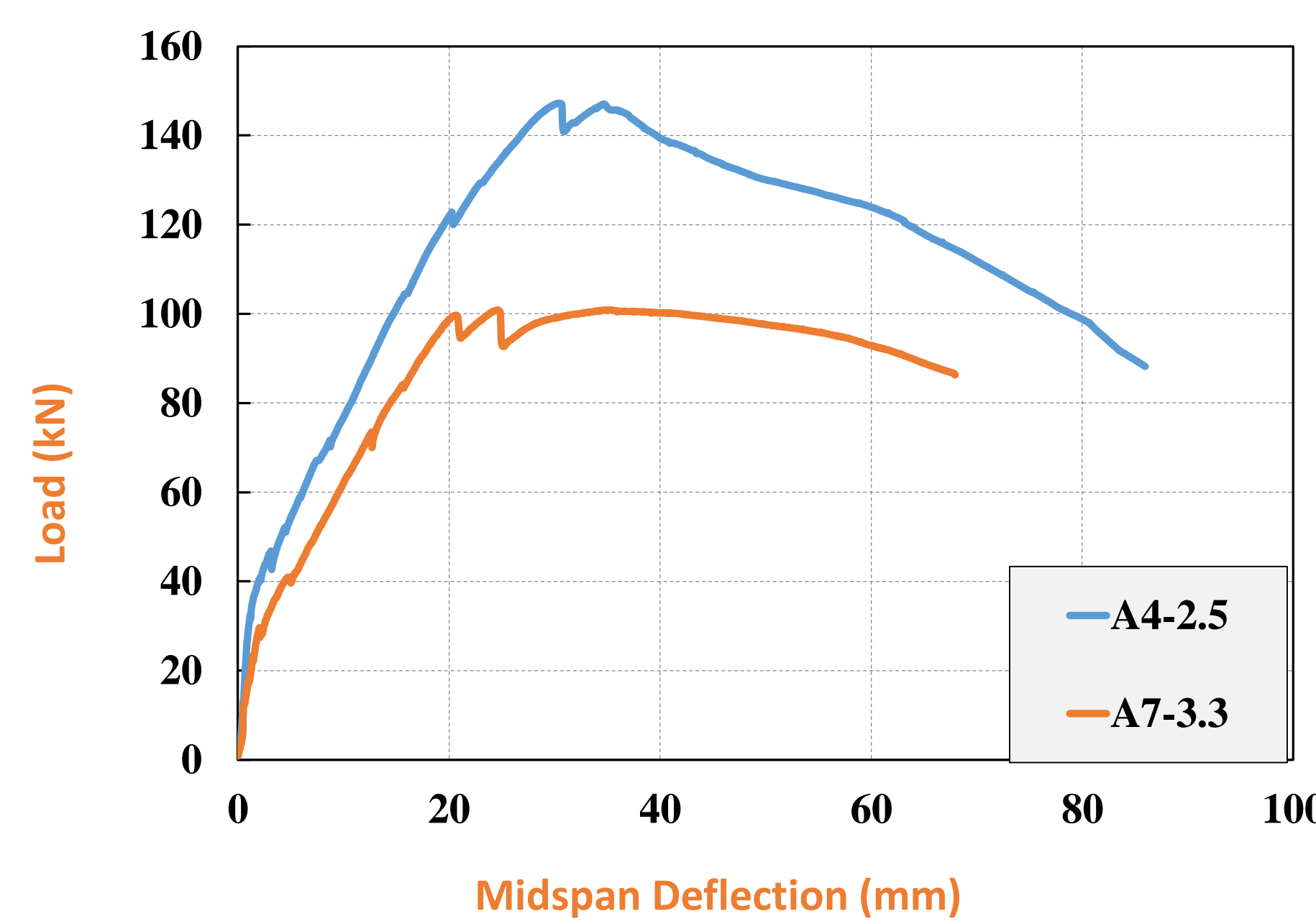

Effect of Span to Depth Ratio

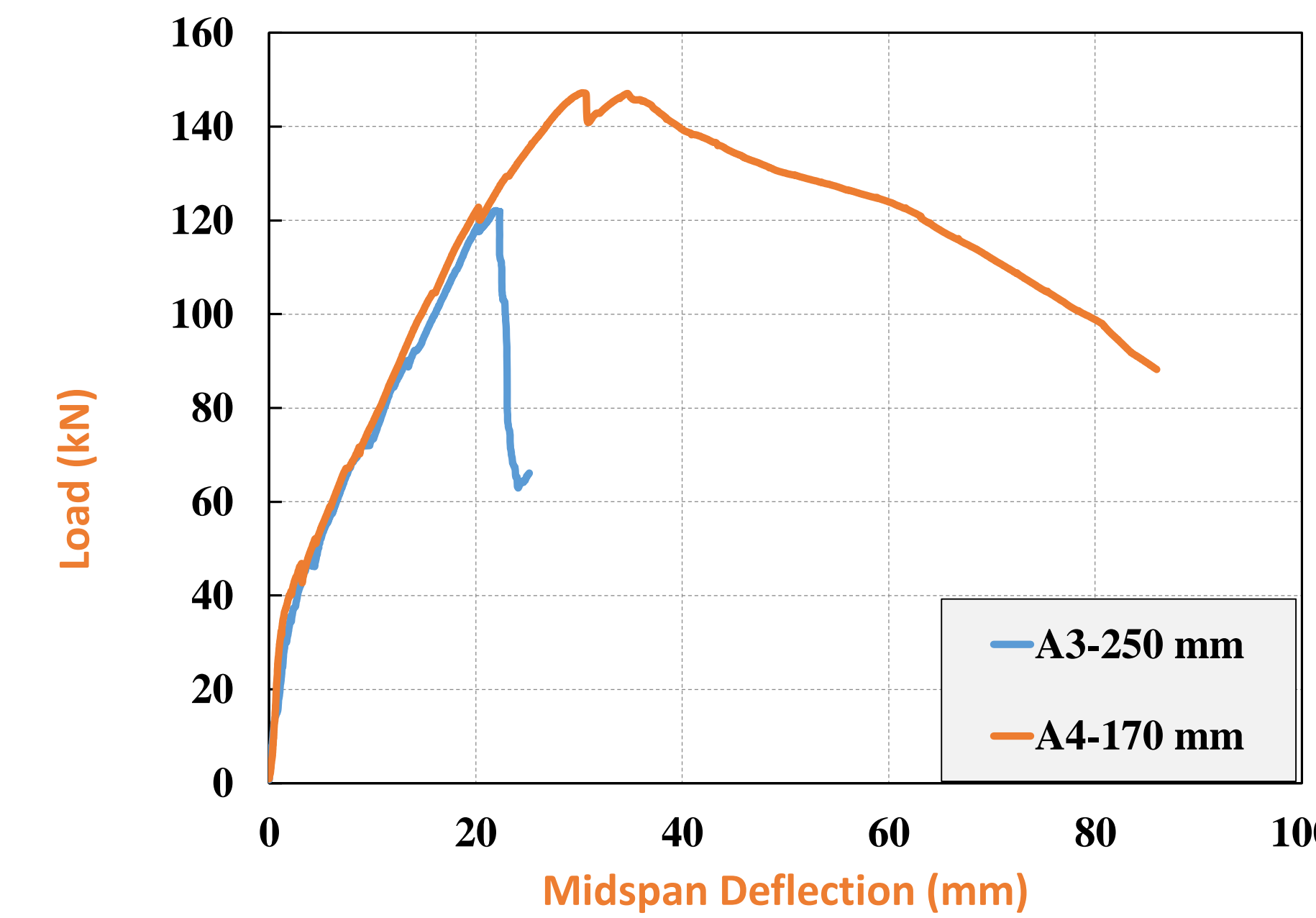

Effect of Spacing Between Stirrups

ANALYTICAL MODEL

$$v_b = 2.84 V_f (l_f/d_f) k_f \sqrt{\rho} f'c \sqrt{E_f/E_s}$$

Basalt Macro-Fibers Prediction Model

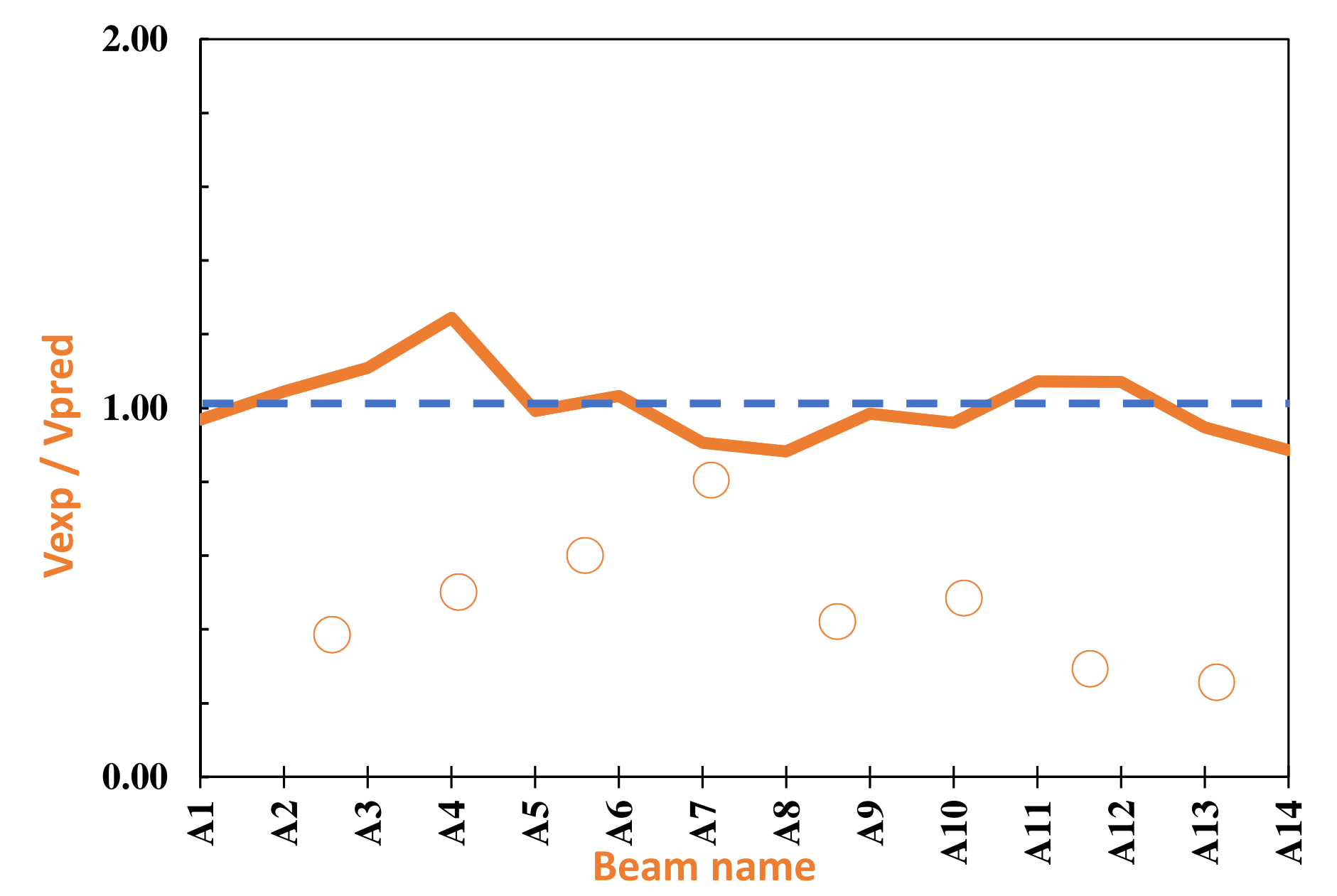

Experimental Vs Predicted Results

INTRODUCTION

The State of Qatar suffers from a harsh environment in the form of high temperature that prevails almost all year round in addition to severe humidity and coastal conditions. This exposure leads to the rapid deterioration and the reduction of the life span of reinforced concrete (RC) infrastructure. The full functionality and safe use of the infrastructure in such environments can only be maintained by holistic approaches including the use of advanced materials for new construction. Therefore, it is essential to investigate the feasibility of using advanced composites, especially fiber reinforced polymer (FRP) materials as a viable alternatives to the traditional construction materials.

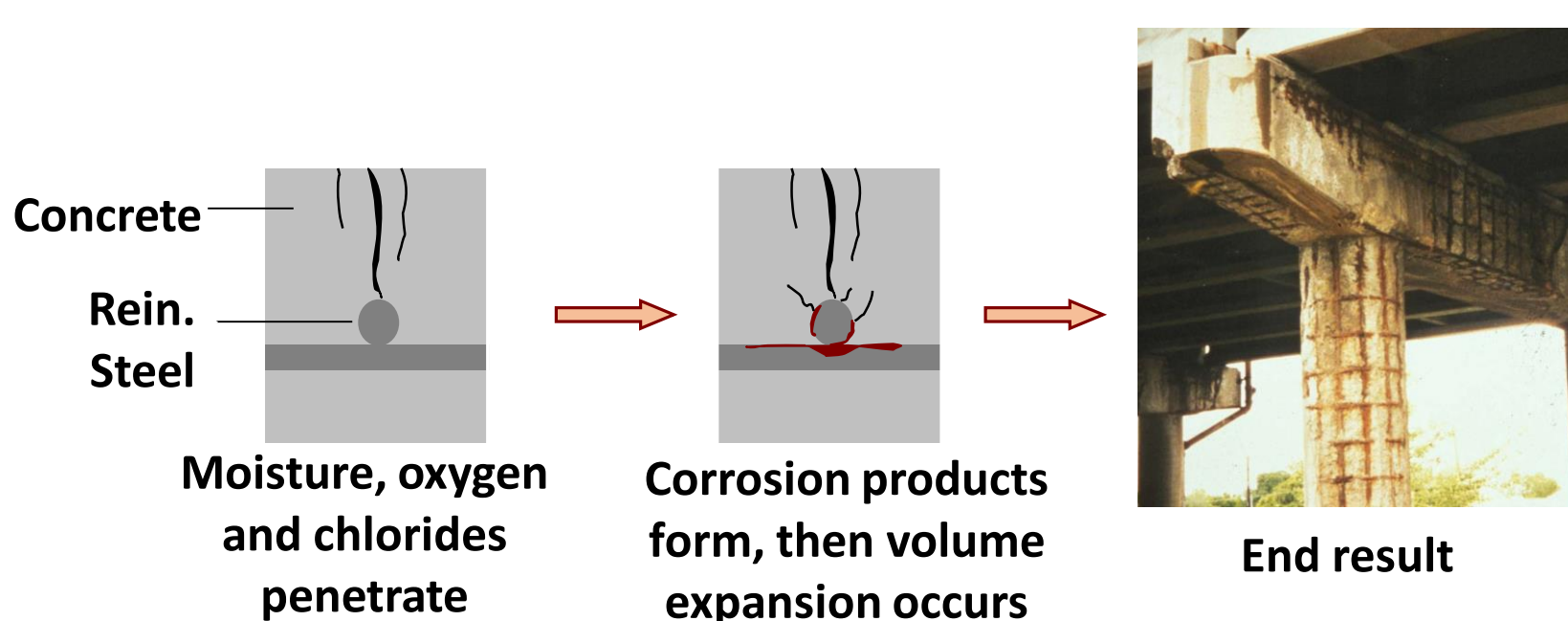

Lightweight
Easy to handle
Corrosion resistant
Durable structures

FRP Materials

High Strength
5x steel
Highly versatile
Suit any project

METHODS AND MATERIALS

- ✓ LARGE-SCALE BEAMS TESTS (Total of 14 Beams):
- **Beam dimensions:** 2000 x 260 x 165 mm
- **Concrete compressive strength:** 35 MPa
- **Reinforcement details:** rho1=2φ12mm; rho2=4φ10mm; rho3=4φ12mm
- **Testing Variables:** (Reinforcement ratio, span to depth ratio, spacing between stirrups, and volume fraction of the basalt macro-fibers).

CONCLUSIONS

The important findings from the experimental investigation are summarized below:

- ✓ Increasing the reinforcement ratio from 0.0067 to 0.0147 revealed an increase in the ultimate load capacity that is ranging from 24% to 48%.
- ✓ Beams with lower a/d ratio have demonstrated higher loading capacity than their counterpart beams with higher a/d ratio, where this increase ranges from 18% to 46%.
- ✓ Reducing the spacing of stirrups have shown a 20% increase in the loading capacity.
- ✓ The ultimate load capacity has experienced an increase of 30% due to the fibers addition.
- ✓ The presence of fibers has altered the mode of failure in several beams from brittle shear failure into ductile flexural failure, allowing them to have a higher load bearing capacity.