

# Optimal operation and management of multi-microgrids using blockchain technology

Misagh Dehghani Ghotbabadi<sup>1</sup>  | Saeed Daneshvar Dehnavi<sup>2</sup> | Hadi Fotoohabadi<sup>3</sup> | Hasan Mehrjerdi<sup>4</sup> | Hossein Chabok<sup>5</sup>

<sup>1</sup> Department of Electrical Engineering, Mapna Group, Shiraz, Iran

<sup>2</sup> Department of Electrical and Computer Engineering, Texas Tech University, Lubbock, Texas, USA

<sup>3</sup> Department of Electrical Engineering, Islamic Azad University, Dariun Branch, Shiraz, Iran

<sup>4</sup> Engineering Department, Qatar University, Doha, Qatar

<sup>5</sup> Software Energy Company, Shiraz, Iran

## Correspondence

Misagh Dehghani Ghotbabadi, Eram Bolv. 652341.  
Email: [Misagh.Dehghani@gmail.com](mailto:Misagh.Dehghani@gmail.com)

## Abstract

This paper tries to address the optimal operation of networked microgrid from the reliability perspective in a correlated atmosphere for the wind generators. The suggested approach performs based on unscented transformation in the form of a nonlinear projection and the heuristic method as the optimizer. The proposed structure is arranged as a complex constraint optimization problem with several targets seeing the varied objectives such as energy not supplied, system interruption frequency, system interruption duration and energy losses. Owing to the interrelated natural surroundings of multi-microgrids, it is a necessity for the microgrids to let the each other access the operation info and with the central unit. In this situation, it is quite wise to provide a secured construction made of the blockchain for the assurance of the reliability and adequate security of data sharing in the microgrids. With the aim of validation of the proposed model, an IEEE standard system is considered and divided into four interrelated microgrids with one side connection to the main grid. The simulation results show the high capability of the proposed framework for enhancing the operation and reliability indices. Moreover, it is seen that almost 0.6% and 0.77% additional cost is imposed to the system in the deterministic framework in the first and second scenarios, respectively.

## 1 | INTRODUCTION

### 1.1 | Motivation and aim

Over the last few years, many disputes have been generated on providing some worthwhile steps to boost the effectiveness and efficiency of the power system. Upon hundreds or even thousands of ideas, distributed generation (DG) promoted the concept of power system into a higher level and have triggered the power system to experience a promising transition. DGs cover both dispatchable and non-dispatchable units, some of which are fuel cell, micro-turbine, solar panels, wind turbines etc. Thanks to the DGs and on the question of mitigating the problems power system face, most researchers called for greater idea named microgrid (MG), benefits from the superior advantages of DG units [1]. This unprecedented effort has made it possible to have a power system with more reliability and

resiliency and less power loss and operation costs etc. [2, 3]. Apart from the advantages, some challenges have come up with MGs which need to be dealt with. Having to deal with the security, stabilization, protection etc. challenges of MGs, researchers divided such systems into AC, DC and hybrid MGs, each one has its own benefits and shortages. MGs operate in both grid-connected mode and islanded mode. The mean by the islanded mode is that the MG is responsible to serve its own demand while it has been disconnected from the main electrical grid. Along with its protective feature against destructive faults, this configuration makes the system more complex. Another beneficial structure of MGs is the networked microgrids (NMGs) which has attracted many attentions. The NMG is basically a set of MGs interconnected together and are able to support each individual MG and, in turn, the whole system. Likewise, each one of the MGs can operate in either connected mode or islanded mode upon a critical situation under discretion of its

This is an open access article under the terms of the [Creative Commons Attribution License](https://creativecommons.org/licenses/by/4.0/), which permits use, distribution and reproduction in any medium, provided the original work is properly cited.

© 2021 The Authors. *IET Renewable Power Generation* published by John Wiley & Sons Ltd on behalf of The Institution of Engineering and Technology

operator. The NMG is a supportive structure for the system in terms of frequency and a protective platform to stop serious disturbances from getting penetrated in the system. However, such structure makes the operation management complex from the perspective of the system operator [4]. In the following, some of the relevant literatures are reviewed and details of which are provided.

## 1.2 | Literature review

Authors in [5] focused on the energy management of NMGs. They introduced a wireless communication platform based on cloud technology aiming to enhance the effectiveness of their energy management procedure within an NMG on a wide area. In [6] provided an effective platform based on droop control for optimal control and management of DG units in an NMG with the goal of promoting the resiliency and reliability of the NMG. Authors in [7] represented a model based on rehabilitated benders decomposition for economic dispatch of multiple NMGs. However, authors utilized complex strategies for supplying their proposed NMGs. An effective reconfiguration based optimal operation management of NMG is provided in [8]. The authors used the reconcilability of the studied NMG to satisfy the objectives related to both the grid-connected and islanded mode of the NMG in the form of master-slave problem. Authors in [9] represented an energy management scheme for a group of grid-connected MGs aiming to reduce the operation cost of the system by optimal dispatch of renewable and storage sources. To do so, they formed the main problem as a multi-objective problem in the form of lexicographic program for facilitating the problem of prioritizing the MGs in their management scheme. A mixed integer linear programming model is developed by authors in [10] for optimal energy management of NMGs. They also considered the dynamic thermal line rating model in their problem to eliminate the contingency of the lines especially during the islanded mode by reconfiguring the NMG. Authors in [11] pursued the reactive power sharing problem in an NMG by developing a wireless based control scheme. By employing virtual impedance controller and local load measurements they claimed that the reactive power sharing problem is carried out promisingly and the global reactive power sharing error is minimized. In [12], authors introduced an online alternating direction method of multipliers (ADMM) algorithm for distributed optimal energy management of NMGs face with high level of uncertainty of DGs. Authors claimed that their approach showed superior advantages compared to the robust based method.

Similar approach pursued in [13] where authors used the ADMM optimization method in a decentralized framework to handle the energy negotiation between distribution system and the NMG. Also, the energy management problem in the studied NMG is formed as a robust model to properly deal with the uncertainties of the NMG.

The above explanations reveal that the researchers have carried out ongoing investigations on the optimal operation, energy exchange and management of the NMGs. These efforts

have been surly accompanied by a proper communication platform and smart equipment, act as an inseparable and undeniable complement of today's power networks. Apart from the comfort they have brought for the system, these platforms have turned into an attractive environment for cyberattacks. These subversive accesses try to penetrate into the system maliciously, and intent of which is to sabotage the system and disrupt the system's performance. As an example, the department of homeland security of the United States confirmed that during 2013–2014, local electric power companies endured more than 224 cyberattacks, aimed to disrupt both generation and consumption sides [14]. These facts indicate that if such stealthy accesses not properly dealt with, they can cause serious damages to the system. Focusing on the interrelation of energy management and data security, let us point out another viewpoint. Many disputes have already been provided over the energy and data transactions safety in the microgrids. The multi-microgrids is not an exception, since they are the body of different agents, generation/consumption units etc., whose are connected and the necessity of providing a safety environment for data and energy trading is requisite. This will pledge the security and safety of data and energy transactions.

Recently, utilization of blockchain technology for enhancing the security of data transaction within the power systems has been investigated by many researchers. Blockchain basically founded on the cryptographic technology for enhancing the security of transactions in an environment, in which all the nodes of the system are responsible to confirm the validity of the transacted data. Authors in [15, 16] investigated the blockchain technology to stop the cyber threats, deceits and decreasing the operation costs of the system. In [17, 18], a secure data transaction framework is investigated based on blockchain technology within the smart cities. A hybrid structure as a combination of both centralized and decentralized models based on blockchain technology is provided in [19] to empower the basic architecture of data transactions. Authors in [20] proposed a blockchain based concept to provide secure demand response program for the smart grid. They presented an algorithm to select suitable nodes for validating the data blocks and adding them to the blockchain. Using blockchain concept, the edge computing and contract theory, the authors in [21] provided a secure energy trading framework for vehicle-to-grid technology with the goal of handling the mismatch of load and supply. Same procedure also pursued in [22]. However, authors used the consortium blockchain framework for energy trading among PEVs. Also, many other works attempted to handle the energy trading issue of smart grids using blockchain technology among different sections of the smart grids [23, 24].

## 1.3 | Contributions and necessity of the work

Although many valuable works are provided in the field, there are still some challenges associated with the NMGs. Investigating a proper model for the electric vehicles and their related

uncertainty as well as the uncertainty associated with renewable sources is still a matter of dispute among researchers. The variability of wind a generation unit and its correlation effect on the performance of the local wind generators needs an accurate modelling which has not been well addressed in previous works. Also, investigating an effective platform for data transactions in an NMG is not an option but an obligation.

Considering the above explanations, this paper is intended to give a reliability oriented stochastic operation management of the NMGs in a correlated environment. The studied NMG comprises renewable energy sources including wind turbines and photovoltaic (PV) units which make the system highly uncertain and need to be properly modelled. Hence, in contrary to some well-known methods for uncertainty modelling including point estimate method, Monte Carlo, scenario-based method [25] etc., unscented transform (UT) is able to model the correlation effect between two different uncertain sources [26]. This paper introduces a stochastic framework based on unscented transform (UT) aiming to model the uncertainty associated with the electric vehicles, energy prices, load demands, renewable energy sources and the correlation among the wind generation units.

The studied microgrids are able to transact energy and data with each other and the main grid. The main problem is formed as a multi-objective optimization model which minimizes the operation costs and some vital reliability indices. The optimization problem is solved by flower pollination algorithm (FPA) as an effective for solving nonlinear multi-objective optimization problems [27]. Also, blockchain based data transmission architecture is provided for the MGs with the goal of enhancing the security of data trading within the studied NMG. All things considered, the main contributions of this work are provided as follows:

- Developing a reliability oriented model for optimal operation management of NMGs in the correlated environment, imposed by the uncertainty associated with the wind farms.
- Since the energy and data transactions' safety highly matters in the smart environments, this paper represents a blockchain based secure data transaction framework aiming to enhance the security and reliability of data trading within the NMGs.
- Proposing an effective stochastic programming model based on UT method for modelling the uncertainty related to the energy prices, load demands, electric vehicles, output power of renewable energy sources and more importantly, the correlation effect among the wind generation units which can significantly affect the performance of the whole system.

The reminder of the paper is as follows: section II explains mathematical formulation of the NMGs, section III describes the blockchain based data transaction framework, section IV is dedicated to the uncertainty modelling based on UT method, section V defines the optimization method based on FPA, results are provided in section VI, and finally the work is concluded in section VII.

## 2 | MATHEMATICAL FORMULATION OF THE NMGs

This section is about to give a proper definition over the mathematical modelling of the NMGs. Firstly the main objective functions are as follows:

### 2.1 | Objective functions

$$\text{Min } F(X) = \left( \begin{array}{l} \text{Cost}^{\text{Grid}} + \text{Cost}^{\text{Loss}} + \text{Cost}^{\text{DG}} + \text{Cost}^{\text{EV}} \\ + \text{Cost}^{\text{ESS}} + \text{Cost}^{\text{ENS}} + \text{SAIFI} + \text{SAIDI} \end{array} \right), \quad (1)$$

$$\text{Cost}^{\text{Grid}} = \sum_{MG=1}^{N_{MG}} \sum_{t=1}^T \alpha_{t,MG}^{\text{Grid}} P_{t,MG}^{\text{Grid}}, \quad (2)$$

$$\text{Cost}^{\text{Loss}} = C^{\text{Loss}} \times \sum_{MG=1}^{N_{MG}} \sum_{br=1}^{N_{br}} \sum_{t=1}^T R_{br,MG} \left| I_{br,t,MG}^2 \right|, \quad (3)$$

$$\text{Cost}^{\text{DG}} = \sum_{MG=1}^{N_{MG}} \sum_{k=1}^{N_{DG}} \sum_{t=1}^T \left( \begin{array}{l} u_{k,t,MG} \beta_{k,t,MG}^{\text{DG}} P_{k,t,MG}^{\text{DG}} \\ + C^{\text{start-up}} \max \\ \{0, u_{k,t,MG} - u_{k,t-1,MG}\} \\ + C^{\text{shut-down}} \max \\ \{0, u_{k,t-1,MG} - u_{k,t,MG}\} \end{array} \right), \quad (4)$$

$$\text{Cost}^{\text{EV}} = \sum_{MG=1}^{N_{MG}} \left( \sum_{ev=1}^{N_{ev}} \sum_{t=1}^T \gamma_{ev,t,MG}^{\text{EV}} P_{ev,t,MG}^{\text{EV}} + \sum_{c=1}^{N_{\text{cycle}}} C_{c,MG}^{\text{deg}} (D_o D_i, D_o D_f) \right), \quad (5)$$

$$\text{Cost}^{\text{ESS}} = \sum_{MG=1}^{N_{MG}} \sum_{ess=1}^{N_{\text{ESS}}} \sum_{t=1}^T \beta_{ess,t,MG}^{\text{ESS}} P_{ess,t,MG}^{\text{ESS}}, \quad (6)$$

$$\text{Cost}^{\text{ENS}} = C^{\text{ENS}} \times \left( \sum_{MG=1}^{N_{MG}} \sum_{cus=1}^{N_{\text{cus}}} L a_{cus,MG} U_{cus,MG} \right), \quad (7)$$

$$\text{SAIFI} = \sum_{MG=1}^{N_{MG}} \left( \frac{\sum_{cus=1}^{N_{\text{cus}}} (\lambda_{cus,MG} \times N_{cus,MG})}{\sum_{cus=1}^{N_{\text{cus}}} N_{cus,MG}} \right), \quad (8)$$

$$\text{SAIDI} = \sum_{MG=1}^{N_{MG}} \left( \frac{\sum_{cus=1}^{N_{\text{cus}}} (U_{cus,MG} \times N_{cus,MG})}{\sum_{cus=1}^{N_{\text{cus}}} N_{cus,MG}} \right). \quad (9)$$

The above equations define the main objective functions of the work. Equation (1) shows the summation of the objective functions which should be minimized and comprises eight different terms, each one is explained in the following. The

objective functions are the cost of power consumption from the main grid (2), power loss (3), operation costs of the DGs (4), EVs (5) and energy storage system (ESS) (6), energy not supplied (ENS) cost (7), SAIFI (8) and SAIDI (9) indices, respectively [29]. Each objective function is defined for each MG and during each hour of the day, which are indicated by subscripts MG and  $t$ , respectively. The  $\alpha_{t,MG}^{Grid}$  is the price of consumed power  $P_{t,MG}^{Grid}$  from the main grid. Also,  $R_{br}$  is the resistance of each branch  $br$ ,  $I_{br}$  is the current of each branch,  $N_{br}$  is the total number of branches,  $\beta_k^{DG}$  is the power price of each DG,  $P_k^{DG}$  is the power consumption from each DG indicated by subscript  $k$ ,  $u_k$  defines the on/off status of DG,  $C^{start-up}$  and  $C^{shut-down}$  are the start-up and shut-down costs of the DGs respectively,  $\gamma_{ev}^{EV}$  and  $P_{ev}^{EV}$  are the discharging price and power of the EVs indicated by subscript  $ev$ , respectively. Based on the initial and final depth of discharge (DoD) within one discharge cycle, total degradation cost of the EVs  $C_c^{deg}$  can be obtained for  $N_{cycle}$  number of charging/discharging cycles [26]. In Equation (6),  $\beta_{ess}^{ESS}$  is the bidding price of the ESS and  $P_{ess}^{ESS}$  is the power of the ESS. In addition,  $C^{ENS}$  is the cost of ENS,  $La_{cus}$  defines the average load connected to a load point,  $U_{cus}$  is the annual outage time of a component,  $\lambda_{cus}$  is the average failure rate of a component and  $N_{cus}$  is the total number of customers served.

## 2.2 | Constraints

### 2.2.1 AC power flow constraints

$$P_{b,t,MG} = \sum_{b=1}^{N_{bus}} |V_{b,t,MG}| |V_{r,t,MG}| |Y_{b,r,MG}| \times \cos(\theta_{b,r,MG} + \delta_{b,t,MG} - \delta_{r,t,MG}), \quad (10)$$

$$Q_{b,t,MG} = \sum_{b=1}^{N_{bus}} |V_{b,t,MG}| |V_{r,t,MG}| |Y_{b,r,MG}| \times \sin(\theta_{b,r,MG} + \delta_{b,t,MG} - \delta_{r,t,MG}). \quad (11)$$

Equations (10) and (11) represent the active and reactive injection power at each bus in the load flow process. The constraints are defined for each MG and during each hour of the day, which are indicated by subscripts MG and  $t$ , respectively.

In the above equations,  $P_b/Q_b$  are the hourly injected active/reactive power at bus  $b$ ,  $V_b$  and  $V_r$  are the voltages of the buses  $b$  and  $r$  respectively,  $Y_{b,r}$  is the admittance of the line between buses  $b$  and  $r$ ,  $\theta_{b,r}$  is the phase of impedance between buses  $b$  and  $r$ ,  $\delta_b$  and  $\delta_r$  are the voltage phases of buses  $b$  and  $r$ , respectively.

### 2.2.2 Constraints related to the power sources

$$P_{k,t,MG}^{DG,\min} \leq P_{k,t,MG}^{DG} \leq P_{k,t,MG}^{DG,\max}, \quad (12)$$

$$Q_{k,t,MG}^{DG,\min} \leq Q_{k,t,MG}^{DG} \leq Q_{k,t,MG}^{DG,\max}, \quad (13)$$

$$P_{k,t,MG}^{Grid,\min} \leq P_{t,MG}^{Grid} \leq P_{k,t,MG}^{Grid,\max}, \quad (14)$$

$$Q_{k,t,MG}^{Grid,\min} \leq Q_{t,MG}^{Grid} \leq Q_{k,t,MG}^{Grid,\max}, \quad (15)$$

$$P_{ess,t,MG}^{ESS,\min} \leq P_{ess,t,MG}^{ESS} \leq P_{ess,t,MG}^{ESS,\max}, \quad (16)$$

$$E_{ess,t,MG}^{ESS} = P_{ess,t-1,MG}^{ESS} + \eta_{cb} P_{ess,t,MG}^{ESS,cb} \Delta t - \frac{1}{\eta_{dcb}} P_{ess,t,MG}^{ESS,dcb} \Delta t, \quad (17)$$

$$E_{ess,t,MG}^{ESS,\min} \leq E_{ess,t,MG}^{ESS} \leq E_{ess,t,MG}^{ESS,\max}, \quad (18)$$

$$P_{ess,t,MG}^{ESS,cb} \leq P_{ess,t,MG}^{ESS,cb,\max}, \quad (19)$$

$$P_{ess,t,MG}^{ESS,dcb} \leq P_{ess,t,MG}^{ESS,dcb,\max}, \quad (20)$$

where constraints (12) and (13) are related to the output of the DG units, constraint (14)-(15) are related to the main grid and (16) corresponded to the ESS. Constraint (17) indicates the hourly energy of the ESS which depends on the status of the ESS in previous hour. Constraint (18) points out that the energy level of the ESS in each hour should be restricted within its maximum and minimum values. Equations (19) and (20) define the limit of charging and discharging rate of the ESS due to its technical restrictions.  $P_{k,t,MG}^{DG,\min}/P_{k,t,MG}^{DG,\max}$  is the min/max active power output of DG units,  $Q_{k,t,MG}^{DG,\min}/Q_{k,t,MG}^{DG,\max}$  is the min/max reactive power output of DG units,  $P_{k,t,MG}^{Grid,\min}/P_{k,t,MG}^{Grid,\max}$  is the min/max active power consumed from the main grid,  $Q_{k,t,MG}^{Grid,\min}/Q_{k,t,MG}^{Grid,\max}$  is the min/max reactive power consumed from the main grid and  $P_{ess,t,MG}^{ESS,\min}/P_{ess,t,MG}^{ESS,\max}$  is the min/max power output of the ESS. In addition,  $E_{ess}^{ESS}$  is the energy level of the ESS,  $P_{ess}^{ESS,cb}/E_{ess}^{ESS,dcb}$  is the charging/discharging power of the ESS,  $\eta_{cb}/\eta_{dcb}$  is the charging/discharging efficiency of the ESS,  $E_{ess}^{ESS,\min}/E_{ess}^{ESS,\max}$  is the min/max energy level of the ESS and  $P_{ess,t,MG}^{ESS,cb,\min}/P_{ess,t,MG}^{ESS,dcb,\max}$  is the max charge/discharge rate of the ESS [30].

### 2.2.3 Maximum power flow in feeders

$$|P_{br,t,MG}| \leq P_{br,MG}^{\max}. \quad (21)$$

The constraint (21) indicates that due to the technical thermal limitations [31] of the power lines, the power value through the branches have to be restricted.  $P_{br}$  is the power injection through the line  $br$  and  $P_{br}^{\max}$  is the maximum capacity of the lines.

## 2.2.4 Constraint related to the voltages of buses

$$V_b^{\min} \leq V_{b,t} \leq V_b^{\max}. \quad (22)$$

The constraint (22) indicates that the voltage values of the buses should be restricted within their max/min values. Also,  $V_b^{\min}/V_b^{\max}$  is the min/max values of voltages of the buses.

## 2.2.5 Constraint related to the EV fleets

$$\xi_{ev,t,MG}^{EV,cb} + \xi_{ev,t,MG}^{EV,dcb} + \xi_{ev,t,MG}^{EV,id} = \xi_{ev,t,MG}, \quad (23)$$

$$P_{ev,MG}^{EV,cb,\min} \leq P_{ev,t,MG}^{EV,cb} \leq P_{ev,MG}^{EV,cb,\max}, \quad (24)$$

$$P_{ev,MG}^{EV,dcb,\min} \leq P_{ev,t,MG}^{EV,dcb} \leq P_{ev,MG}^{EV,dcb,\max}, \quad (25)$$

$$E_{ev,t}^{EV} = E_{ev,t}^{EV,ini} + \sum_{m'=1}^t \left( \begin{array}{l} \xi_{ev,t}^{EV,cb} P_{ev,m'}^{EV,cb} \eta_{ev}^{EV,cb} \\ - \xi_{ev,t}^{EV,dcb} P_{ev,m'}^{EV,dcb} \eta_{ev}^{EV,dcb} \end{array} \right) - \sum_{m'=1}^t (1 - \xi_{ev,m'}) E_{ev,m'}^{EV,req} \quad (26)$$

$$E_{ev,t}^{EV,\min} \leq E_{ev,t}^{EV} \leq E_{ev,t}^{EV,\max}. \quad (27)$$

Since the PEVs exchange energy with electrical grid by V2G technology, Equation (23) is necessary to determine the mode of operation.  $\xi_{ev,t}^{EV,cb}$ ,  $\xi_{ev,t}^{EV,dcb}$ ,  $\xi_{ev,t}^{EV,id}$  are binary variables indicate the status of EVs if they are in charging mode, discharging mode or idle mode, respectively. In (24) and (25) the restrictions over the charging  $P_{ev,t,MG}^{EV,cb}$  and discharging power  $P_{ev,t,MG}^{EV,dcb}$  of the EVs are represented, respectively. Also,  $P_{ev,MG}^{EV,cb,\min}/P_{ev,MG}^{EV,cb,\max}$  is the min/max charging power of the EVs and  $P_{ev,MG}^{EV,dcb,\min}/P_{ev,MG}^{EV,dcb,\max}$  is the min/max discharging power of the EVs. Constraint (26) defines the energy balance of EVs' fleets.  $E_{ev,t}^{EV,ini}$  is the energy level of EVs' batteries,  $\eta_{ev}^{EV,cb}/\eta_{ev}^{EV,dcb}$  is the charging/discharging efficiencies of the EVs' batteries and  $E_{ev,t}^{EV,req}$  is the required energy for EVs in fleet  $ev$  to drive [32]. Also, constraint (27) defines the hourly energy level of the EV fleets. In addition to the above constraints, beginning and final energy level of the batteries should be equal and it is assumed the EVs are fully charged at the start of their first travel.

## 3 | BLOCKCHAIN BASED DATA TRANSMISSION FRAMEWORK

This section is dedicated to the definition of blockchain technology and the studied data security framework. As it was mentioned earlier, the NMG is an interconnected structure between

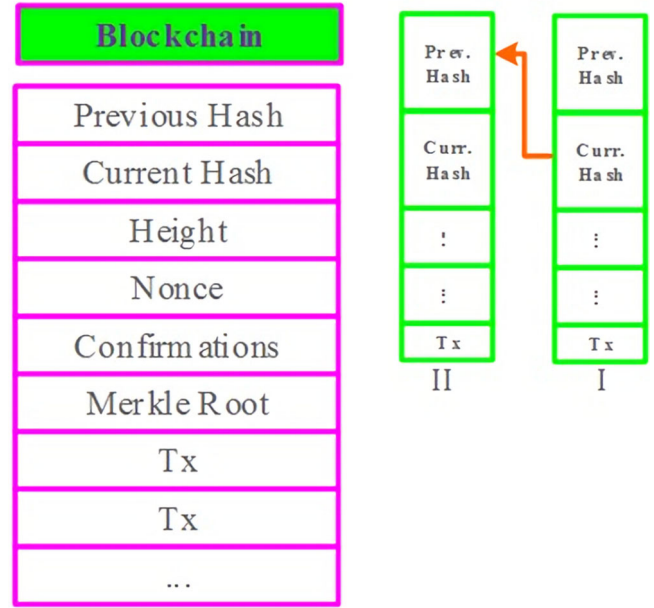
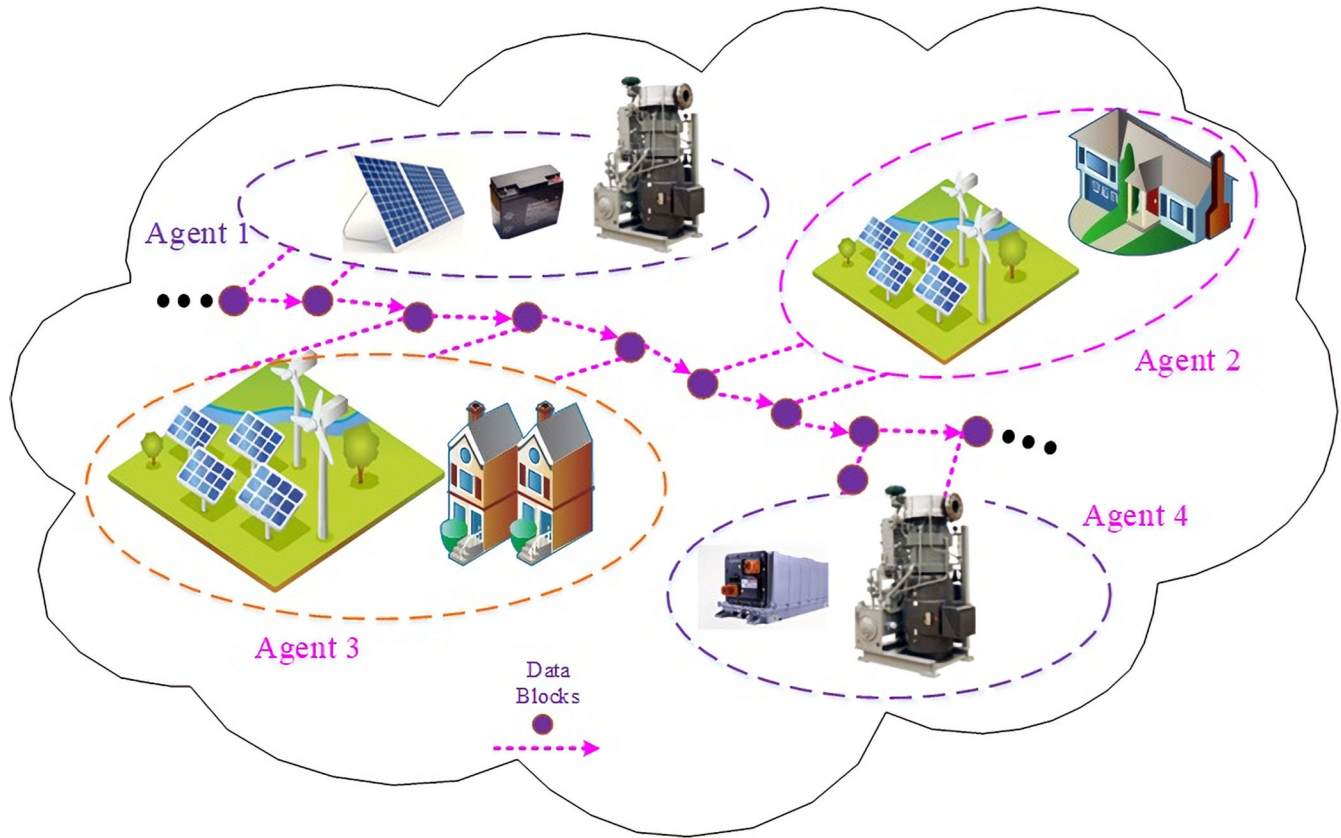

FIGURE 1 Structure of data block

a number of MGs that support each other and the whole system as well. Due to the interconnected feature of the NMG, the MGs need to have data exchange with each other and the central control and management unit. In this regard, an appropriate data transaction framework should be provided to guarantee the security and reliability of data exchange process.

Blockchain is basically a secure and decentralized framework in which all the nodes of the system are connected together. This technology is against this backdrop that the data could be transmitted to a central unit and then broadcasted to all the nodes of the system, similar to the performance of the systems so-called “supervisory control and data acquisition (SCADA)”. Such systems, however, put the system at the risk and are highly vulnerable to data attacks since only one particular unit is responsible to receive, process and broadcast the data across the system. In such system if the central unit got attacked, this could affect the entire system and might disrupt the whole performance in case of serious attacks. In this regard, some researchers declared that it would be well worth if every node in the system broadcast its own information to the other nodes in a decentralized manner. This eliminates a particular central unit in the system and, in turn, diminishes the risk of noneligible accesses. In this architecture, each node of the system creates its own data blocks and transmits them to the other nodes. These data blocks are sealed with hash addresses (HAs) and signed by a private key which is unique for the creator. Nodes of the system can access to the data blocks by using their public key. Figure 1 depicts the illustrative representation of the structure of a data block. As can be seen, the data block comprises different parts, two of which are the current HA and previous HA. This figure also shows two consecutive data blocks which are sent at  $t$  and  $t + i$  where  $i$  varies from case to case and depends on the preferences of the system's agent. This actually indicates the time period between two sequential data transactions. It is evident that the current



**FIGURE 2** Implementation of blockchain in NMG

HA of the data block sent at  $t$  is considered as the previous HA of the data block sent at  $t+i$ . Such feature creates a cyclic form over the data blocks and enhances the security of the data trading, since if the HA is manipulated due to any reason, the receiver recognizes the difference by doing a simple and rational comparison. Figure 2 shows the implementation of the blockchain architecture on the studied NMG. It is evident that each one of the agents (MGs) broadcasts its own information through a data block. The data blocks form a blockchain, and the agents can access the blocks. No central data management unit exists, and the security of data trading is enhanced remarkably.

It is crystal clear that the blockchain performance heavily links to the small volume of data. However, in case of big data transactions, things might be changed due to the high number of generation/consumption units. The necessity of transmitting their related big data can reduce the performance of the blockchain. In this regard, the average latency of the proposed blockchain model is assessed using Apache JMeter version 5.1.1, aiming to evaluate the authenticity of the studied model. The Apache JMeter is an appropriate tool for performance evaluation of different applications [35]. A proper simulation in the Apache JMeter over a range of users can result in obtaining the latency of the proposed structure. Figure 3 illustrates the average latency of the proposed structure versus the throughput of the model. Basically, throughput implies the rate of message prosperously delivered to the receiver through a communication

link, which is measured in Kb/sec in Jmeter tool. Figure 3 shows that although the average latency of the structure increases as the throughput of the system makes an upward trend, the average latency reaches to its top most which is nearly 15 ms and is admissible for the analysis of this study in the proposed NMGs.

#### 4 | STOCHASTIC MODELING BASED ON UT METHOD

In this section, the stochastic modelling based on the UT method is represented. As previously mentioned, the uncertainty associated with the output power of the wind turbines and their correlation effect on each other needs to be properly modelled. Among the estimate methods, this is the only method (to the best of authors' knowledge), which can handle the correlated uncertainty. It means that none of the methods can make a good approximation about the correlation, but rather would ignore its effect and focus on the self-randomness or uncertainty. This is not a real case for the wind turbines, since the wind speed and direction changes when hitting a wind turbine in a wind farm. Therefore, the next wind unit may experience a changed (affected) wind speed and direction different from the previous neighbouring one. The UT method as a key element has shown superior advantages in terms of simplicity and accuracy compared to the Monte Carlo and scenario based

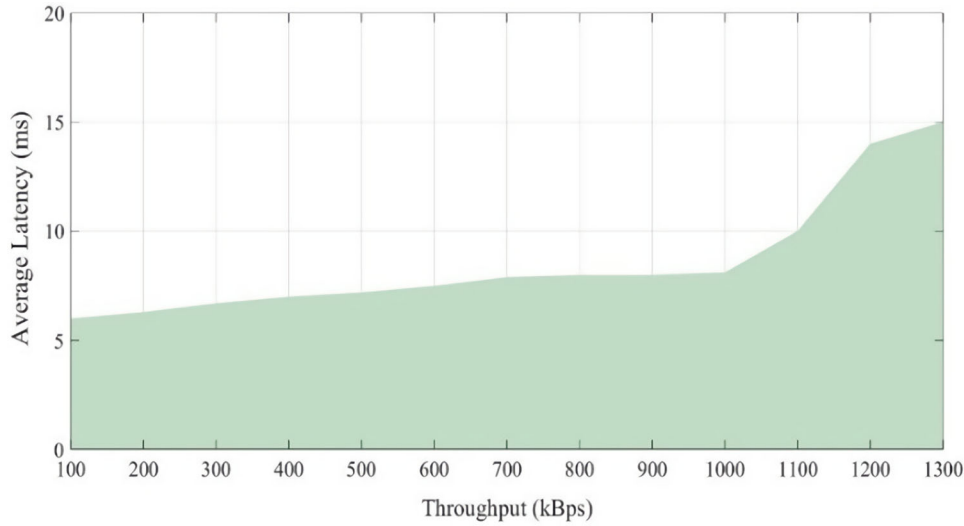

FIGURE 3 Latency of the proposed blockchain based architecture

method [33] which need high number of samples for modelling. Also, in contrary to the proposed methods as well as point estimate approach, the UT method is able to model the correlation among wind turbines, which makes this method worth of usage [26]. The UT definition begins with assuming a nonlinear function  $\mathbf{A} = f(\mathbf{B})$  where  $\mathbf{A}$  is the vector of stochastic outputs and  $\mathbf{B}$  is the vector of stochastic inputs. Assume  $\mathbf{B}$  includes  $m$  number of uncertain parameters with length of  $m$ , mean value of  $\omega_B$  and covariance of  $Q_B$ . Symmetric elements of  $Q_B$  indicate the uncertain parameters and the non-symmetric elements reveal two related parameters. In a problem with  $m$  number of uncertain variable, the UT method solves a problem for  $2m + 1$  times for modelling the uncertainty. The following steps should be carried out for finding the mean value and covariance of the output  $\mathbf{A}$ .

**Step 1:** firstly,  $2m + 1$  samples are calculated from the uncertain input data as follows:

$$B^0 = \zeta_B, \quad (28)$$

$$B^\kappa = \zeta_B + \left( \sqrt{\frac{m}{1-\chi} Q_B} \right)_\kappa \quad \forall \kappa \in \Omega^\kappa, \quad (29)$$

$$B^{\kappa+m} = \zeta_B - \left( \sqrt{\frac{m}{1-\chi} Q_B} \right)_\kappa \quad \forall \kappa \in \Omega^\kappa, \quad (30)$$

where  $\chi$  is the weight of the mean value  $\zeta_B$ . The symbol  $\chi$  shows the weighting factor assigned to the deterministic framework which is determined manually based on the experience of the decision-maker and uncertainty level of the system. In order words, the mean of the uncertain parameters has the highest probability in a normal distribution function which roots in the historical recording data of the uncertain parameter. Moreover,

TABLE 1 Comparison between different uncertainty modelling methods

Methods	Accuracy	Complexity	Correlation
Scenario-based	Low	High	×
Cloud	High	Low	×
Point estimate method (PEM)	Medium	Medium	×
UT	High	Medium	✓

the decision maker can decide to change this value depending on the new values of the uncertain parameters and their differences with their forecast values.

**Step 2:** for each sample point, a weighting factor need to be obtained as follows:

$$\zeta_B^\kappa = \frac{1-\chi}{2m} \quad \forall \kappa \in \Omega^\kappa. \quad (31)$$

The sum of the weights must be 1.

**Step 3:** the  $2m + 1$  input samples are imposed to the proposed nonlinear function and  $2m + 1$  output samples will be obtained.

**Step 4:** finally, the covariance ( $Q_A$ ) and mean value of output samples ( $\zeta_A$ ) as follows:

$$\zeta_A = \sum_{\kappa \in \Omega^\kappa} \zeta_B^\kappa f^\kappa, \quad (32)$$

$$Q_A = \sum_{\kappa \in \Omega^\kappa} \zeta_B^\kappa (f^\kappa - \zeta_B) (f^\kappa - \zeta_B)^T. \quad (33)$$

Also, Table 1 compares four different uncertainty modelling methods from the perspective of accuracy, complexity and correlation. It shows that the UT method provides high accuracy

while imposing medium complexity to the system and is capable of modelling the correlation effect between the uncertain factors which is unattainable by the others.

## 5 | OPTIMIZATION METHOD: FLOWER POLLINATION ALGORITHM

In this section, the FPA as an effective and powerful optimization method for solving the studied stochastic operation model of the NMG is provided and is discussed in detail.

Generally speaking, the FPA is a bio-inspired optimization algorithm which was firstly introduced based on the pollination process of flowers. Two different forms have been founded for the pollination process including abiotic and biotic forms. In contrary to the former, the latter form needs carriers (animals) for handling the pollens conveyance. Some carriers prefer some special plants for carrying out the pollination process and ignore the other species which is called flower constancy [27]. The flower constancy brings two main advantages for both the flowers and carriers: 1) this will increase the chance of reproduction of that particular flower and 2) the carriers do not need much effort to find new species for doing the pollination process and this is an optimum option from their perspectives. Basically, the pollination can be achieved by two different ways including self-pollination and cross-pollination. The cross-pollination is a process in which the pollens of a flower from a different plant is the main reason for pollination process. The flying carriers play significant role in performing such pollination, hence, this can occur in long distances. On the flip side, self-pollination is a process that fertilization process occurs between same flowers of one particular species. Considering the above fundamentals about the pollination process, the following rules can be obtained from the aforementioned explanations and are the foundations of the FPA:

**Rule #1:** the biotic and cross-pollination are defined as the global pollination.

**Rule #2:** the abiotic and self-pollination are defined as the local pollination.

**Rule #3:** flower constancy can be represented by the similarity of two flowers.

**Rule #4:** a switch probability  $p \in [0, 1]$  can be defined which controls the local and global pollinations. Due to some reasons, the local pollination is more probable to occur considering the  $p$  value. The algorithm starts with producing a random number of flower/pollens; each one can be a solution. Equation (34) shows a global search, drawn from both the first rule and flower constancy.

$$x_f^{iter+1} = x_f^{iter} + L(x_f^{iter} + s_{best}^{iter}). \quad (34)$$

In the above equation,  $x_f^{iter}$  is a solution at iteration  $iter$ ,  $L$  is step size of the flying carrier roles as the pollinator and  $s_{best}^{iter}$  is the

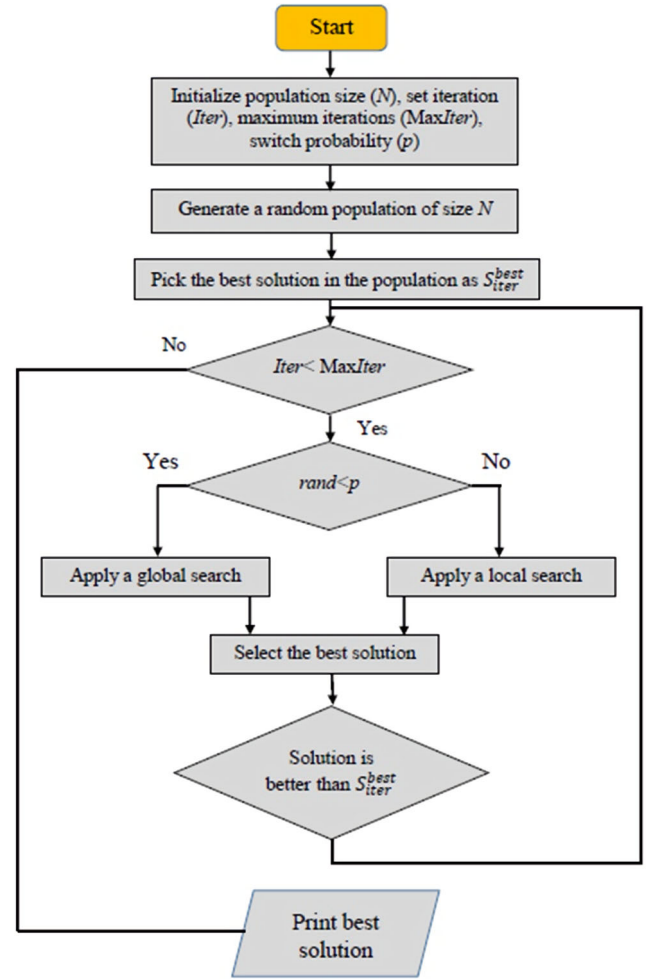

FIGURE 4 FPA flowchart

best solution candidate among generated candidates at that particular  $iter$ .  $L$  can be obtained from levy distribution as follows:

$$L \sim \frac{\lambda \Gamma(\lambda) \sin(\pi\lambda/2)}{\pi} \frac{1}{s^{1+\lambda}} \quad (s > 0), \quad (35)$$

where  $\Gamma(\lambda)$  is the standard gamma function and  $\lambda$  is typically 1.5. According to the definition of the second rule and constancy flower, the following equation which is a local search would be achieved:

$$x_f^{iter+1} = x_f^{iter} + \varepsilon(x_k^{iter} - x_{k'}^{iter}) \quad (36)$$

$x_k^{iter}$  and  $x_{k'}^{iter}$  are pollens from different flowers of the same species. The pollination can occur in both local and global pollinations. To have this definition, rule four and a switch probability  $p$  is defined and the pollination can be switched from one to another. In this work, the proposed multi-objective operation management problem is solved using the FPA method which has shown superior advantages in terms of accuracy, convergence rate and CPU time compared to some of the well-known metaheuristic algorithm such as particle



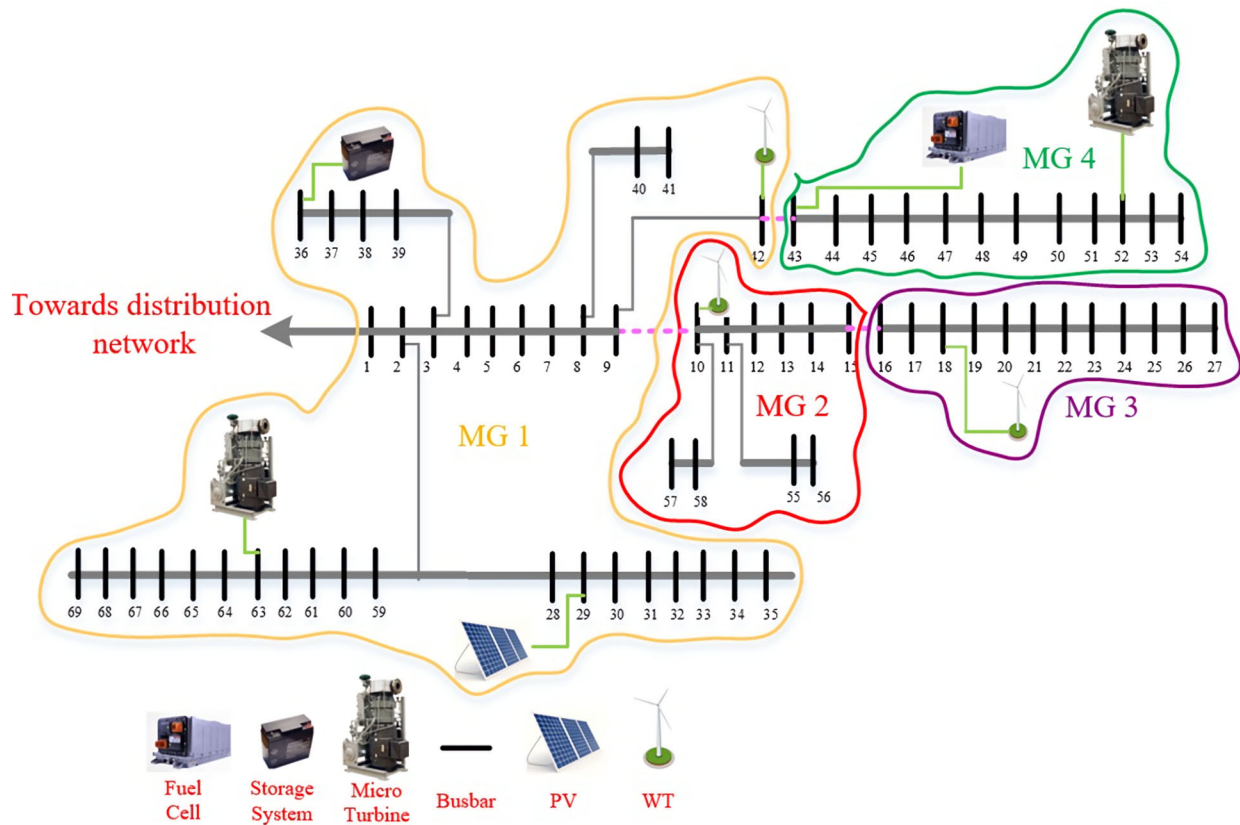

FIGURE 5 The proposed test system for assessing the model performance [17]

swarm optimization (PSO), hybrid PSO, modified PSO, genetic algorithm (GA), firefly algorithm (FA), gravitational search algorithm (GSA), artificial bee colony (ABC) algorithm etc. [28, 36]. Figure 4 depicts the flowchart of the proposed FPA.

## 6 | SIMULATION RESULTS

This section is dedicated to the performance analysis of the studied framework. The proposed stochastic operation management model is implemented on a 69-bus test NMGs which includes four different MGs that are connected together. The simulation took almost 120 s and is performed using MATLAB software on a desktop computer with 3.4 GHz processor and 32 GB of RAM. The illustrative representation of the tested model is depicted in Figure 5. Each one of the MGs comprises different DG units, locations of which are shown in Figure 5. The studied NMG has also three electric vehicle fleets which can travel from one MG to another. Fleets number 1, 2 and 3 travel between buses 4–37, 53–27 and 13–49, respectively. The details of the fleets are represented in Tables 2 and 3. As it is evident from Figure 5, the MGs are connected together through the dashed lines. Other system data are drawn from [34]. As it was previously mentioned, the tested NMG consists of different DG units, the characteristics of which including the cost coefficient, capacity limits and start-up and shut-down costs are

TABLE 2 PEV fleet journey features

Fleet No#	Primary journey		Next journey		Primary journey		Next journey	
	Departure		Arrival		Departure		Arrival	
	Time	Bus	Time	Bus	Time	Bus	Time	Bus
1	7:00	5	9:00	33	16:00	33	18:00	5
2	9:00	52	10:00	23	19:00	23	20:00	52
3	9:00	12	10:00	47	14:00	47	15:00	12

TABLE 3 The features of the PEVs

Fleet number	Capacity (kWh)		Charge/discharge rate (kW)	
	Min	Max	Min	Max
1	263	1973	7.3	496
2	219	1644	7.3	292
3	210	1812	7.3	313

expressed in Table 4. Two main case studies are provided to assess the performance of the studied model:

1. Analysis of Blockchain based data transaction model
2. Analysis of energy transaction in the studied NMGs

Each one will be discussed in Sections 6.1 and 6.2.

**TABLE 4** Characteristics of the DGs in the networked microgrid (D: Dispatchable, ND: Non-dispatchable)

Unit	Cost coefficient (\$/kWh)	Min–Maxcapacity (kW)	ON/OFF costs
WindUnit1	1.0744	0–1600	0
WindUnit2	1.074	0–1920	0
PV	2.436	0–2300	0
FuelCell	0.287	90,1400	0.88
MicroTurbine1	0.466	120,1500	1.76
MicroTurbine2	0.466	120,1700	1.76
Battery	–	–200,+2000	0
Utility	–	500,2500	–

**TABLE 5** Structure of data block for MG 1 at  $t = 10$  and 11 in scenario 1

Block for MG 1			
$t = 10$		$T = 11$	
Previous HA		Previous HA	
dd24faa16c3d55ee93ae2e39bb15face		Eef194bc6aa295ccdefae77bf6a13bb	
Current HA		Current HA	
Eef194bc6aa295ccdefae77bf6a13bb		13d9faeb2911ffceef64be2411fecab	
Output power (KW)	Price (\$/KWh)	Output power (KW)	Price (\$/KWh)
1900	13	3400	15

## 6.1 | Analysis of blockchain based data transaction model

In this section, the data transaction framework based on the blockchain technology is assessed. As it was mentioned before, the MGs transact data through the blockchain by using data blocks sealed and signed by each agent. In this analysis, it is assumed that the data blocks are sealed by the HAs which are 32-bit compounded words using the hash function SHA-256, consisting of numbers and letters {0-9, A-F} [18]. The HA function generates random HAs for each data transaction process. Hence, unauthorized access or data manipulation will be immediately recognized as soon as the receiver starts processing the received data block. Tables 5 and 6 show the structure

**TABLE 6** Structure of data block for MG 4 at  $t = 15$  and 16 in scenario 2

Block for MG 4			
$t = 15$		$T = 16$	
Previous HA		Previous HA	
efecabaaefdaeff39ab26188aafbea31		abfe491abbeef81779abeff57abeff992	
Current HA		Current HA	
bfe491abbeef81779abeff57abeff992		11589feab365711cc663951bbeefac2	
Output power (KW)	Price (\$/KWh)	Output power (KW)	Price (\$/KWh)
1450	5	2050	8

of data block for MG1 and MG 4, respectively. The structure of the blocks is determined for two consecutive hours to show the dependency of the HAs. It can be seen that the MG 1 has generated 1900 kW power at  $t = 10$  and is able to sell its additional power for 13 \$/KWh. These values are changed to 3400 kW and 15 \$/KWh at  $t = 11$  and are accessible for the other agents. Also, Table 6 shows the data block of MG 4 at  $t = 15$  and 16 in the second scenario. The output power of the MG 4 is 1450 kW for  $t = 15$  and the additional power is sold at 5 \$/KWh. At  $t = 16$ , the MG 4 has increased its generation by 43.38% and sold its additional power for 15 \$/KWh. These values are visible for agents and inform them to buy or sell their power if they are willing to. In addition, such secure platform could act as a supportive system for V2G of vehicles by exchanging data among the agents and inform them from the EVs status, available power etc.

## 6.2 | Analysis of energy transaction in the studied NMGs

Figure 6 shows the considered wind turbine power pattern. To better highlight the performance of the represented model, two different scenarios are considered which will be discussed in detail. Details of the scenarios are defined in Table 7. These scenarios mainly focus on the effect assessment of the storage system and DG units on the operation of the NMG. In the first scenario, storage system is neglected, but the DG units can be either in operational mode or non-operational mode to see if this influences the performance of the NMGs. In the second scenario, all units are activated in the system which brings the highest availability in the system.

The output generated power of the units is depicted in Figure 7 for the first scenario within the 24 h daily horizon. Here the units can operate in the non-operational mode, which is obvious during early hours of the day. On the other hand, fuel cell and micro turbines started producing power after  $t = 8$ . This reveals that the system is more tended to supply its demand from the main electricity grid between  $b = 1$  and 8 due to its lower price compared to the MGs' power units. In the second scenario, the storage system is activated and it is expected to play a promising role in the system. Figure 8 illustrates the output generated power of the units in the second scenario. The power units are less operated, specially the fuel cell unit, due to the presence of the storage system. Also, due to the zero cost coefficient of the storage system and its promising ability in storing energy, the storage system is more tended to be used in the operation problem. In this regard, the system prefers the storage unit to be charged during low-price hours and discharged during high-price hours, especially in the middle of the day. This cost effective approach can significantly reduce the operation cost of the system.

Performance analysis of the EV fleets is also worth of explanation. In this regard, Figure 9 is depicted to show the charging or discharging status of the EV fleets through the operation horizon. The negative values indicate the discharging mode and the positive values define the charging mode of the EVs.

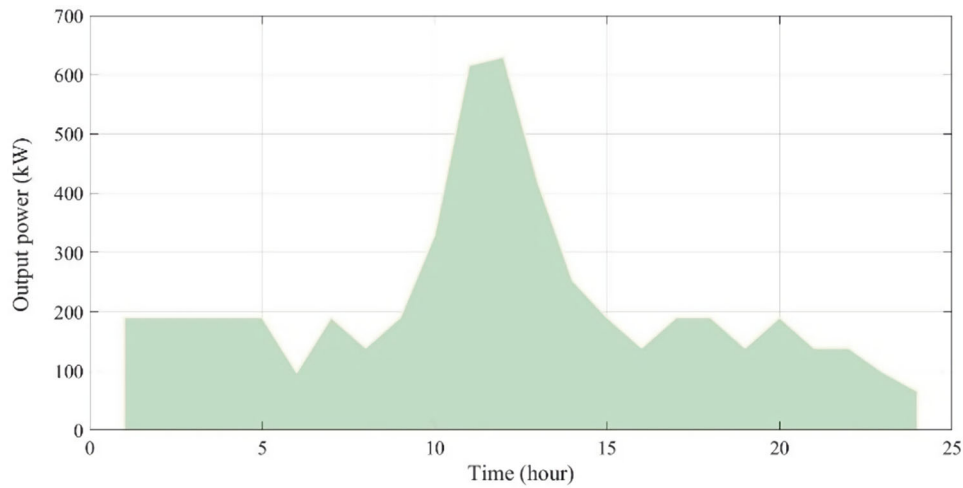

**FIGURE 6** Wind turbine output power pattern

**TABLE 7** Scenarios definition

	Storage system	DGs
First scenario	Out-of-service	Either operational or non-operational mode
Second scenario	Activated	Either operational or non-operational mode

It is crystal clear that the third EV fleet is more employed in the system compared to the others. Hence, some explanations are needed here. Compared to the fleet number 1, EV fleet 3 is more available in the system, since EV fleet 1 spends 4 h in this day on the road to arrive at its destination. On the other hand, the availability of the third EV fleet is two times higher than

the first one which persuades the system to use the third fleet more. In comparison with the second EV fleet, fleet number 3 has higher capacity and charging/discharging rate which makes this fleet more applicable and useable in the system.

To better show the performance of the studied model, the stochastic analysis of the model should be analysed as well. As mentioned earlier, the performance of the NMGs are surely affected by the uncertainty factors in the system including the energy prices, load demands, electric vehicles, output power of renewable energy sources and more importantly, the correlation effect among the wind generation units. The effect of these factors should be assessed which is shown in Figure 10 which clearly indicates a comparison between the stochastic and deterministic analysis of the studied model in all scenarios. It can be seen that the total values of the objective function in the

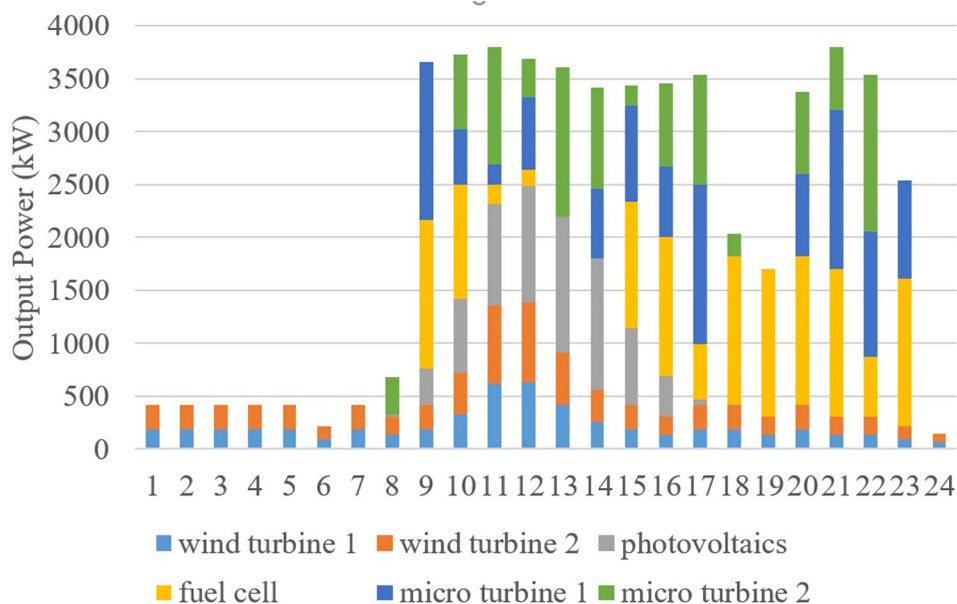

**FIGURE 7** Power output of the units in the first scenario

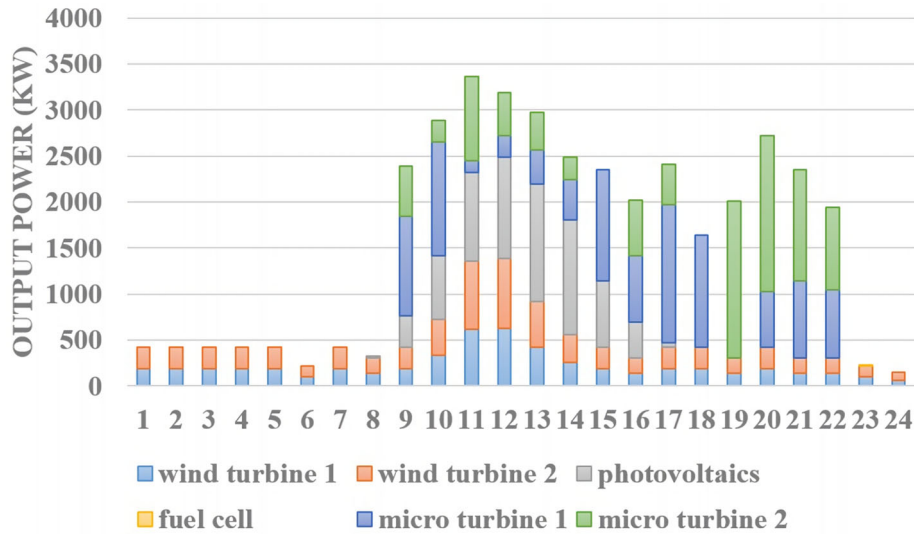

FIGURE 8 Power output of the units in the second scenario

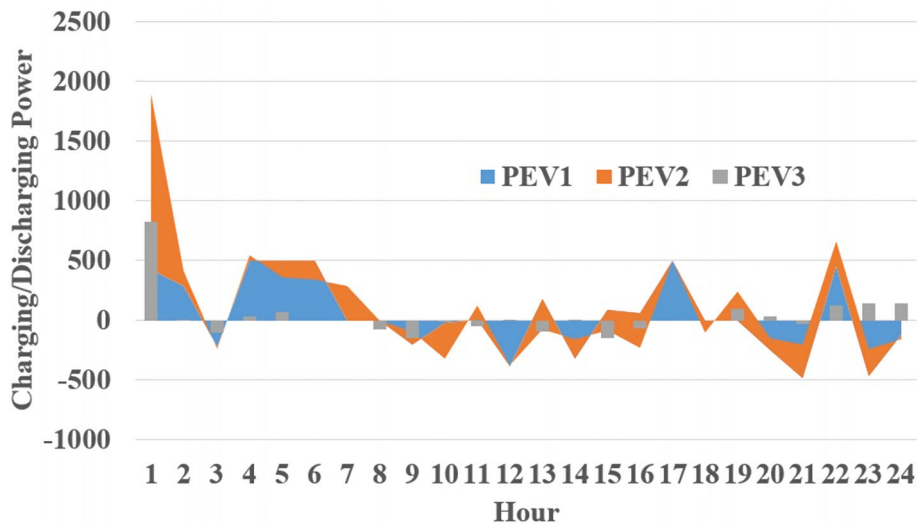

FIGURE 9 Injection or consumption power of the EV fleets

stochastic analysis for all scenarios are more than the amount of the deterministic framework. The additional cost is the cost imposed to the system due to the errors of forecasting the aforementioned uncertainty factors.

## 7 | CONCLUSION

This paper basically concentrates on proposing a reliability oriented optimal operation management of NMGs in a correlated environment. Considering the correlation environment among the WTs of the NMG, the UT method as an effective approach was employed to handle the uncertainties of the NMG and specifically the correlation effect of WTs. The MGs are able to transact energy and data with each other aiming to supply their own demand and also get some credit by selling their additional power. Different DG units including WT, PV, micro tur-

bine, storage system and fuel cell is considered in the NMG. Also, three different EV fleets are modelled in the system to make the model more realistic. To show the effectiveness of the model, different case studies are provided to analyse the authenticity of the work. The proposed method uses two key approaches: 1) unscented transform and 2) FPA. The first one is used for modelling the uncertainty. UT is an approximate method which needs the PDF of the uncertain parameter to handle the randomness in the cost function. The main advantage of this method is the ability of modelling the correlated uncertainty with just the first few moments of the PDF. The disadvantage of this method is the need for the PDF which might not be available for the random variables with limited historical data. For the FPA, it is a heuristic method which can solve any complex optimization method without making any assumption. The main advantage of this method is its compatibility with

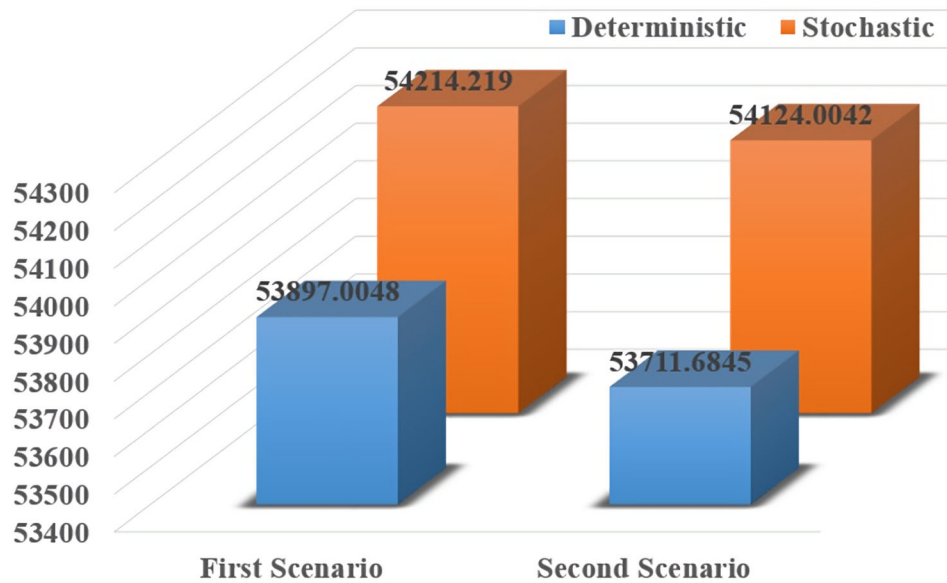

FIGURE 10 Stochastic and deterministic analysis of the NMGs

any type of optimization problem, regardless of the type, discrete, continuous etc. The disadvantage of this method comes around the random nature of the search process which is common among all evolving optimization algorithms. Having considered the proposed case studies, it was seen that one scenario in which the DGs are allowed to be switched on/off beside the utilization of storage system was the most reasonable and profitable scenario since the storage could be charged during low price hours and discharged during high price-hours. In fact, the storage system caused some of the expensive generation units to be switched off and by turning off such DGs, the total operation cost of the system was remarkably reduced. Security of data trading was also pursued in this paper by using blockchain technology. It was seen that through this method, the data related to the MGs could be transmitted securely without getting affected by any malicious third party. This secure platform could also support the EVs by providing a reliable environment for transmitting their information since they travel between the agents. To better highlight the studied model, both deterministic and stochastic frameworks of the studied model were assessed. For future scope of this work, the smart grid can also be considered as another agent in the study or the data security of multi-microgrids in multi area framework and how they negotiate over the energy they need can also be investigated in future works.

## ORCID

Misagh Dehghani Ghotbabadi  <https://orcid.org/0000-0001-7022-8025>

## REFERENCES

- Chen, X., et al.: Land-sea relay fishery networked microgrids under the background of cyber-physical fusion: Characteristics and key issues prospect. *Information Processing in Agriculture*. Available online 9 March 2021. In press, corrected proof
- Wu, Y., et al.: Risk assessment of renewable energy-based island micro-grid using the HFLTS-cloud model method. *J. Cleaner Prod.* 284, 125362 (2020)
- Dabbaghjamanesh, M., et al.: Effective scheduling of reconfigurable microgrids with dynamic thermal line rating. *IEEE Trans. Indus. Elec.* 9, 1–12 (2018)
- Wang, B., et al.: Cybersecurity enhancement of power trading within the networked microgrids based on blockchain and directed acyclic graph approach. *IEEE Trans. Indus. Appl.* 55(6), 7300–7309 (2019)
- Borojeni, K., et al.: A novel cloud-based platform for implementation of oblivious power routing for clusters of microgrids. *IEEE Access* 5, 607–619 (2016)
- Han, Y., et al. MAS-based distributed coordinated control and optimization in microgrid and microgrid clusters: A comprehensive overview. *IEEE Trans. Power Elec.* 33(8), 6488–6508 (2017)
- Li, Z., Shahidehpour, M.: Privacy-preserving collaborative operation of networked microgrids with the local utility grid based on enhanced benders decomposition. *IEEE Trans. Smart Grid* 11(3), 2638–2651 (2020)
- Kavousi-Fard, A., et al.: Effective dynamic scheduling of reconfigurable microgrids. *IEEE Trans. Power Sys.* 33(5), 5519–5530 (2018)
- Nikmehr, N.: Distributed robust operational optimization of networked microgrids embedded interconnected energy hubs. *Energy* 19915, 117440 (2020)
- Dabbaghjamanesh, M., et al.: A novel distributed cloud-fog based framework for energy management of networked microgrids. *IEEE Trans. Power Sys.* 35(4), 2847–2861 ((2020))
- Jalali, M., et al.: Strategic decision-making of distribution network operator with multi-microgrids considering demand response program. *Energy* 14115, 1059–1071 (2017)
- Ma, W.J., et al.: Distributed energy management for networked microgrids using online ADMM with regret. *IEEE Trans. on Smart Grid* 9(2), 847–856 (2016)
- Gao, H., et al.: Decentralized energy management for networked microgrids in future distribution systems. *IEEE Trans. Power Syst.* 33(4), 3599–3610 (2017)
- Pagliery, J.: Hackers attacked the U.S. Energy Grid 79 times this year. <http://money.cnn.com/2014/11/18/technology/security/energy-grid-hack/>. Accessed 10 Mar 2017

15. Ashley, M.J., Johnson, M.S.: Establishing a secure, transparent, and autonomous blockchain of custody for renewable energy credits and carbon credits. *IEEE Eng. Manage. Rev.* 46, 100–102 (2018)
16. Sarda, P., et al.: Blockchain for fraud prevention: A work-history fraud prevention system. In: *IEEE Conference on Trust, Security and Privacy*, pp. 1858–1863. IEEE, Piscataway (2018)
17. Biswas, K., Muthukumarasamy, V.: Securing smart cities using blockchain technology. In: *2016 IEEE 18th International Conference on High Performance Computing and Communications; IEEE 14th International Conference on Smart City; IEEE 2nd International Conference on Data Science and Systems (HPCC/SmartCity/DSS)*, pp. 1392–1393. IEEE, Piscataway (2016)
18. Liang, G., et al.: Distributed blockchain-based data protection framework for modern power systems against cyber attacks. *IEEE Trans. Smart Grid* 10, 3162–3173 (2018)
19. Sharma, P.K., Park, J.H.: Blockchain based hybrid network architecture for the smart city. *Future Gener. Comput. Syst.* 86, 650–655 (2018)
20. Jindal, A., et al.: GUARDIAN: Blockchain-based secure demand response management in smart grid system. *IEEE Trans. Serv. Comput.* 13(4), 613–624 (2019)
21. Zhou, Z., et al.: Secure and efficient vehicle-to-grid energy trading in cyber physical systems: Integration of blockchain and edge computing. *IEEE Trans. Syst. Man Cybern.: Syst.* 50(1), 43–57 (2019)
22. Kang, J., et al.: Enabling localized peer-to-peer electricity trading among plug-in hybrid electric vehicles using consortium blockchains. *IEEE Trans. Ind. Inf.* 13(6), 3154–3164 (2017)
23. Liu, C., et al.: Adaptive blockchain-based electric vehicle participation scheme in smart grid platform. *IEEE Access* 6, 25657–25665 (2018)
24. Sun, G., et al.: Blockchain Enhanced high-confidence energy sharing in internet of electric vehicles. *IEEE IoT J.* 7(9), 7868–7882 (2020)
25. Roustai, M., et al.: A scenario-based optimization of Smart Energy Hub operation in a stochastic environment using conditional-value-at-risk. *Sustain. Cities Soc.* 39, 309–316 (2018)
26. Kavousi-Fard, A., et al.: Stochastic reconfiguration and optimal coordination of V2G plug-in electric vehicles considering correlated wind power generation. *IEEE Trans. Sustain. Energy* 6(3), 822–830 (2015)
27. Kavousi-Fard, A.: Modeling uncertainty in tidal current forecast using prediction interval-based SVR. *IEEE Trans. Sustain. Energy* 8(2), 708–715 (2016)
28. Abdelaziz, A.Y., et al.: Combined economic and emission dispatch solution using flower pollination algorithm. *Int. J. Electr. Power Energy Syst.* 80, 264–274 (2016)
29. Kavousi-Fard, A., Niknam, T.: Multi-objective stochastic distribution feeder reconfiguration from the reliability point of view. *Energy* 64, 342–354 (2014)
30. Chabok, H., et al.: On the assessment of the impact of a price-maker energy storage unit on the operation of power system: The ISO point of view. *Energy* 190, 116224 (2020)
31. Dabbaghjamanesh, M., et al.: Effective scheduling of reconfigurable microgrids with dynamic thermal line rating. *IEEE Trans. Ind. Electron.* 66, 1552–1564 (2019)
32. Zare, M., et al.: Smart coordinated management of distribution networks with high penetration of PEVs using FLC. *IET Gener. Transm. Distrib.* 14(3), 476–485 (2019)
33. Roustaei, M., et al.: A scenario-based approach for the design of smart energy and water hub. *Energy* 195, 116931 (2020)
34. Kavousi-Fard, A., et al.: Stochastic resilient post-hurricane power system recovery based on mobile emergency resources and reconfigurable networked microgrids. *IEEE Access* 6, 72311–72326 (2018)
35. Niranjanamurthy, M., et al.: Comparative study on performance testing with jmeter. *Int. J. Adv. Res. Comput. Commun. Eng.* 5(2), 70–76 (2016)
36. Mohamed, M.A., et al.: Stochastic and distributed scheduling of shipboard power systems using MFOA-ADMM. *Energy* 206, 118041 (2020)

**How to cite this article:** Ghotbabadi, M.D., et al.: Optimal operation and management of multi-microgrids using blockchain technology. *IET Renew. Power Gener.* 1–14 (2021). <https://doi.org/10.1049/rpg2.12238>