

# The impact of PV generation and load types on the impedance relays during both balanced and unbalanced faults

DOI : 10.36909/jer.13285

Rashad M. Kamel<sup>\*1,\*\*2</sup> , Heba M. Abdullah<sup>\*1,\*\*\*3</sup>

<sup>1</sup>Electrical \*Electrical Engineering Department College of Engineering and Petroleum, Kuwait University, Kuwait,

<sup>2</sup>\*\* Electrical Engineering Department, Faculty of Engineering, Assuit University, Assuit, Egypt

<sup>3</sup>Electrical \*\*\*Electrical Engineering Department College of Engineering, Qatar University, Doha  
rmkamelm@gmail.com, Habdullah\_ee@yahoo.com

**Abstract-** Photovoltaic (PV) power generation and the types of connected loads both have an effect on protective impedance relays' readings. This paper investigates this effect in a real distribution system installed in the State of Kuwait. It is found that, both the dynamic loads and the PV plants have considerable effects in the relay impedance value which vary according to the load type, PV connection and fault locationplace. Both single phase to ground fault (unsymmetrical fault) and three phase fault (symmetrical fault) are investigated. When single line to ground fault occurs at the PV bus (far from relay location), the dynamic loads increase the relay impedance while the PV plant decreases the relay impedance. When a single phase to ground fault occurs at the relay bus (load bus), the dynamic load decreases the relay impedance and the PV plant increases it. For a three-phase to ground fault at the relay bus, both dynamic load percentages and PV plant power generation have no effect on the protective relay impedance readings. At this condition, the relay impedance totally depends on the fault resistance. The main finding of this paper is that both the load type (especially dynamic load) and the PV plant have dominant effects on the protective impedance relay reading and setting. The distribution system planners and operators must consider the PV plant and types of load during designing, setting and adjusting the

protective impedance relays. The most important point in this paper is considering real case study. This means that, the obtained results are more realistic than the assumed system in the other research.

If the fault occurs at the location of the PV system's bus when no PV power is generated, the dynamic load causes the relay impedance to increase, while connecting the PV decreases the relay impedance. The relay's resistance and reactance increase from  $0.3153\Omega$  and  $1.4950\Omega$ , to  $0.3456\Omega$  and  $1.6617\Omega$  respectively when the dynamic load increases from 25% to 90% of the total load at constant high fault resistance. The relay resistance and reactance decrease from  $0.2849\Omega$  and  $0.3443\Omega$  (without PV plant), to  $0.2195\Omega$  and  $0.3137\Omega$  (with PV), respectively. When the dynamic load percentage increases from 25% to 90%, the resistance and reactance of the relay decrease from  $1.0488\Omega$  and  $0.0051\Omega$ , to  $0.9526\Omega$  and  $0.0008\Omega$ , respectively. This phenomenon is valid for all expected fault resistances. When considering constant dynamic load percentage and constant fault resistance, the relay resistance and reactance increase from  $1.375\Omega$  and  $0.0022\Omega$  (without PV) to  $1.5745\Omega$  and  $0.0726\Omega$  (with PV), respectively. Based on those results, the impedance relay setting must be adjusted according to the percentage of the dynamic loads percentage, the PV penetration level, and the fault location.

**Keywords:** PV, static loads, dynamic loads, impedance relay, relay setting, fault resistance, symmetrical and unsymmetrical faults.

## 1. Introduction

For the past years, solar energy generation has increased significantly. The aim of PV integration is to reduce the carbon emissions by reducing the generated power from conventional fossil fuel power plants. Many studies are focusing on the impacts of PV distributed generation (PVDG) on the distribution side, which have various issues on the power system because of its interment nature. Some

of the complications caused by PVDG are harmonics, voltage and frequency variations and power imbalance. The issues related to PV penetration and its impacts on the power system are reviewed in [1] (Karimi et al., 2016) and [2] (Eltawil and Zhao, 2010).

Photovoltaic designs, operations and maintenances are reviewed in [3] (Hernández-Callejo et al., 2019). Monitoring Photovoltaic distributed generation (PVDG) is necessary because of the intermittent nature of PV where it requires real-time performance monitoring for system control and protection [4](Madeti and Singh, 2017a). PV power flow can be reversed where it can cause voltage rise unlike conventional power plants [5](Masters, 2002).

A more recent study distinguishes between voltage increasing and voltage decreasing of a power system with PV reverse flow which depends on the impedance of the line and the PV system power factor [6](lioka et al., 2019). It is proposed by (Mortazavi et al., 2015) [7] to utilize impedance measurements of the distance relays for monitoring power system loading and PV system power penetration. The measured apparent impedance is the combination of both the load and line impedances .

Integrating DG to the conventional power grid can impact protection system coordination and therefore requires modified protection schemes (Darwish et al., 2013)[8]. The impact of high PV penetration is modelled and studies for a balanced three phase system in (Bracale et al., 2017) [9]. Interconnecting PVDG to the power system can cause changes in the apparent impedances and affect the function of distance relays [10](Sorrentino et al., 2018). The protection challenges are review in [11](Telukunta et al., 2017). A new approach to adjust protection relays considers fault current limiters with minimum number of relays to be adjusted [12](Ibrahim et al., 2017). A design procedure for over current relay with renewable generation is proposed in [13](Chen, 2017). False detection caused by distribution of non-linear loads is studied in [14](Soheili et al., 2018). The effect of Static Synchronous Series Compensator (SSSC) on distance relay calculation is investigated in [15](Ghorbani et al., 2012).

Different types of fault detections for both ac and dc sides of the PV power systems are reviewed in [16](Madeti and Singh, 2017b).

A study in (Kim and Aggarwal, 2006) [17] suggests utilizing the distance relay for monitoring the transmission line operating condition. An online-measurement procedure for improving the distance relay accuracy is proposed which can be used during normal or fault conditions. The protection relay setting depends on the accurate phasor measurements of the voltage and current.

Up to the author's knowledge, limited published work deals with the impact of load types on the impedance relay reading combined with DG. Also, the effects of DGs especially the PV on the protective relay readings and settings are not investigated in detail where the published work mostly assumed distribution system loads as constant power static loads and did not consider other load types such as rotating loads (dynamic loads) combined with PVDG.

In latest work related to this topic, a study by (Mishra et al., 2021) considers a 39-bus system with a 300 MW renewable plant modelled in PSCAD. The study investigates a large PV plant and at one location in the power system. The authors proposed an adoptive relay technique that measures the line impedance up to the fault point and obtains a deviation angle to adjust the relay setting.

The main goal of this study is a detailed investigation and analysis of the effects of load types with PVDG on the impedance relay reading and setting. This paper considers both rotating and static load types. In addition, the faults are simulated at different location (at PV bus or at load bus) and their effects on the relay reading and setting are studied in detail. The remaining of the paper is organized as follows:

Section 2 describes the real distribution system with installed PV (10 MWp) and real loads. Section 3 deals with a mathematical analysis and description of different types of load. Also, the influence of the PV on the fault current of the distribution system has been described in section 3. Section 4 analyzes the performance of the impedance protective relay under symmetrical and unsymmetrical faults. Section 5 displays the obtained results with different load types and with or without PV under both symmetrical and unsymmetrical faults and reports the main finding of paper. Conclusions are reported in section 6.

## 2. Methodology Architecture of the investigated distribution network with PV and loads

### 2.2.1 Flow chart

In this section, we summarize the methods used for investigating the effect of both PV and load type effect on the impedance relay. We generalize the procedure into the chart in Fig.1 so it can be a useful tool for other researcher and for future studies. The first step is to model the power systems involved in the study including the distribution system and the solar power system. Then, we model the overall power system in ETAP software in order to perform the short circuit analysis in step 4. different scenarios are under investigation to study the effect of fault location, fault impedance, fault type, and load type, on the obtained results.

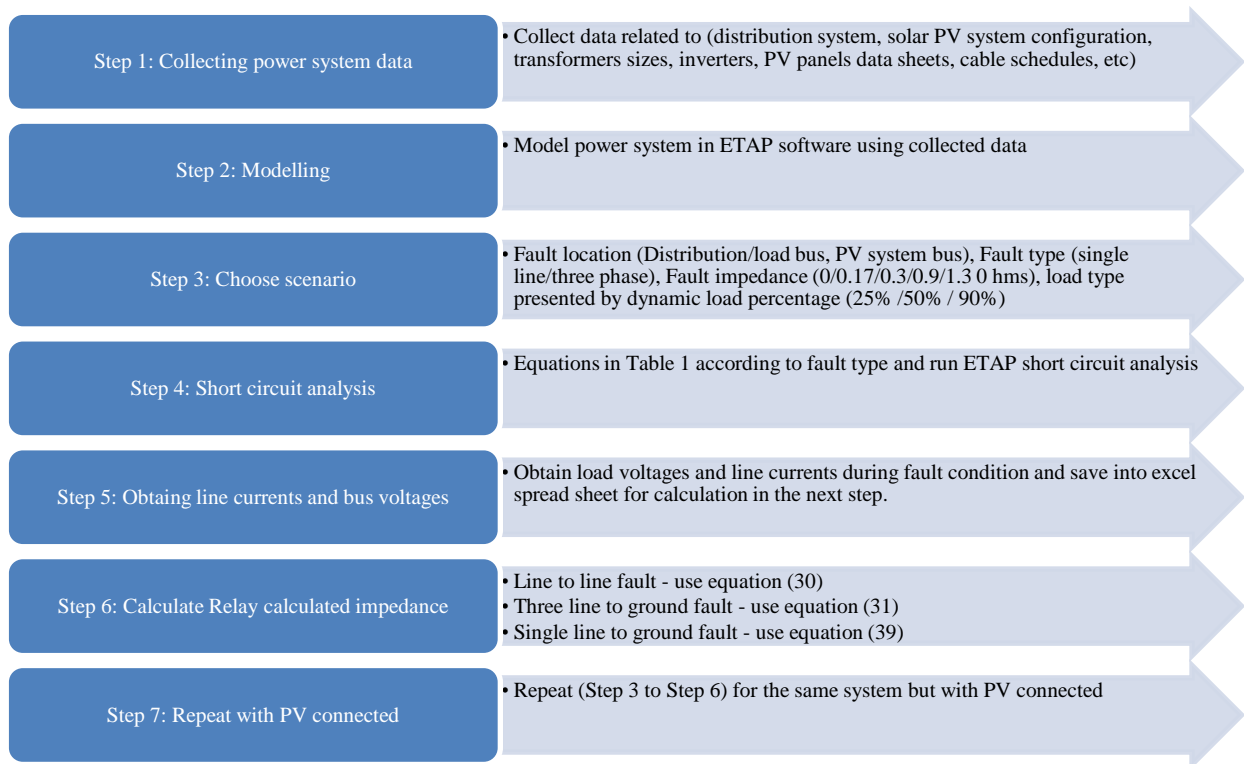

A

10MWp grid connected PV plant to one of the Kuwait Oil Company's (KOC) electrical distribution system which supplies electricity to oil pump at the Umm-Gudair field, West Kuwait (Fig. 1.a.) [18]. The distribution system which contains the PV plant is shown in Fig.1.b. The main grid feeding the load bus (KOC bus) is the "Minagish B" substation . Four feeders (incomers) coming from the "Minagish B" substation (11 kV) and represent bus 1 (Fig.1.b). Three of the four incomers are continuous, and one

is spare for redundancy. The four incomers are operating with closed breakers. The 11 kV load bus is Bus2 (Fig.1.b). The PV plant is installed at Bus 3. The distances between different buses are shown in Fig. 1(1.b) [18].

Fig.1. Summary of calculation methodology

## **2.2 Architecture of the investigated distribution network with PV and loads**

A 10MWp grid connected PV plant to one of the Kuwait Oil Company's (KOC) electrical distribution system which supplies electricity to oil pump at the Umm-Gudair field, West Kuwait (Abdullah et al., 2016) . The distribution system which contains the PV plant is shown in Fig.2.b. The main grid feeding the load bus (KOC bus) is the "Minagish B" substation. Four feeders (incomers) coming from the "Minagish B" substation (11 kV) and represent bus 1 (Fig.2.b). Three of the four incomers are continuous, and one is spare for redundancy. The four incomers are operating with closed breakers. The 11 kV load bus is Bus2 (Fig.2). The PV plant is installed at Bus 3. The distances between different buses are shown in Fig.2 (Abdullah et al., 2016).

## **4.3. Mathematical analysis and modelling of different loads and PV interfacing inverter**

### **4.3.1 Different load types**

There are two main types of the electrical loads, static and dynamic (rotating) loads. The description and mathematical modelling of the two load types are described in the following subsections.

#### **4.3.1.1 Static load modelling**

A static load model is the characteristics of the load as a function of the voltage and frequency (IEEE Task Force on Load Representation for Dynamic Performance, 1993), (Abdullah et al., 2016), and (Kamel and Nagasaka, 2015)[19-21]. The static load real power ( $P$ ) and imaginary power ( $Q$ )

components are considered separately. The dependency of real power ( $P$ ) and imaginary power ( $Q$ ) on the magnitude of the voltage ( $V$ ) can be calculated as follows (Kamel and Nagasaka, 2015) [21]:-

$$P = P_o (\bar{V})^a , \quad (1)$$

$$Q = Q_o (\bar{V})^b , \quad (2)$$

$$\bar{V} = \frac{V}{V_o} ,$$

$$(3)$$

where  $P_o, Q_o, V_o$  represent initial conditions of the real, imaginary powers and voltage, respectively. The  $a$ , and  $b$  are the parameters of the load model. Three models are available as follows [20 -21](Kundur, 1994), and (Kamel and Nagasaka, 2015):

- a) Static load with constant power when the parameters  $a = b = \text{zero}$ .
- b) Static load with constant impedance when the parameters  $a = b = 1$ .
- c) Static load with a constant current when  $a = b = 2$ .



Fig1.a: 10 MWp grid connected PV located west Kuwait

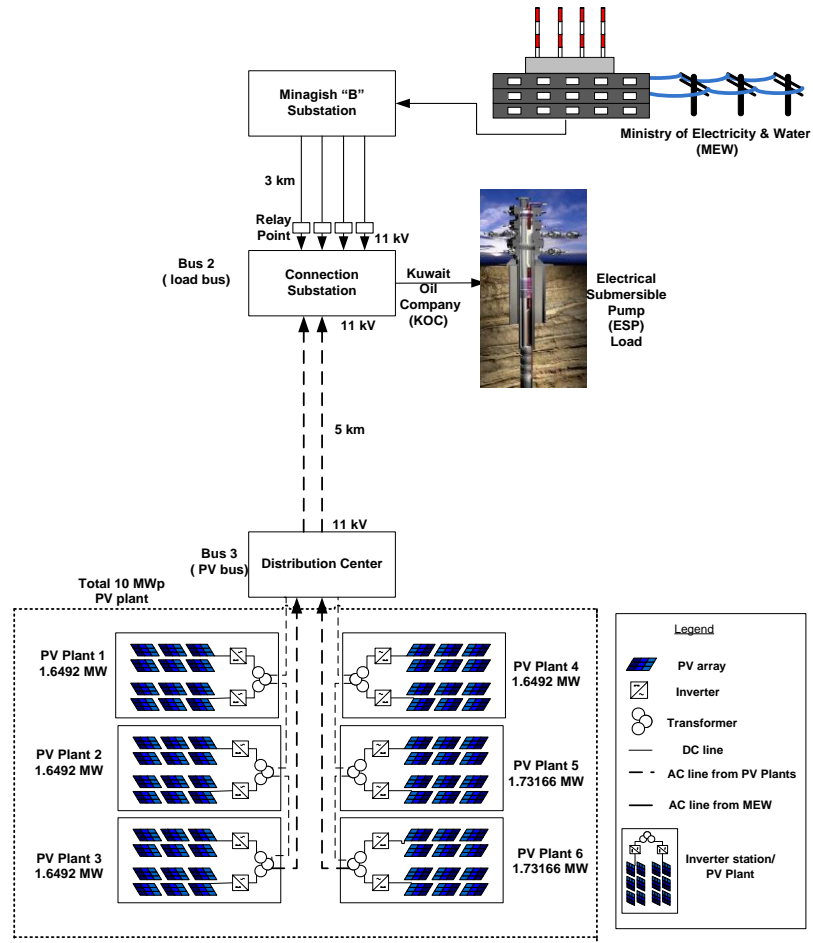

Fig.21.b: Case study, power system configuration and single line diagram (Abdullah et al., 2016)[18]

The voltage dependency of load model is given by the following equation:

$$P = P_o [p_1 \bar{V}^{-2} + p_2 \bar{V}^{-1} + p_3], \quad (4)$$

$$Q = Q_o [q_1 \bar{V}^{-2} + q_2 \bar{V}^{-1} + q_3] \quad (5)$$

The effect of frequency on the load characteristics is given by the following equation: -

$$P = P_o (\bar{V})^a (1 + k_{pf} \Delta f), \quad (6)$$

$$Q = Q_o (\bar{V})^b (1 + k_{qf} \Delta f), \quad (7)$$

or

$$P = P_o [p_1 \bar{V}^{-2} + p_2 \bar{V}^{-1} + p_3](1 + k_{pf} \Delta f), \quad (8)$$



$$Q = Q_o [q_1 \bar{V}^{-2} + q_2 \bar{V} + q_3](1 + k_{qf} \Delta f), \quad (9)$$

where,  $\Delta f$  represents the frequency deviation ( $f - f_o$ ). Typically,  $k_{pf}$  is between 0 to 3.0 and  $k_{qf}$  is between 0 to -2.0 (Concordia and Ihara, 1982)[22].

A general model for static load is given as follows (Kamel and Nagasaka, 2015), [21], and [23](Kundur et al., 1993):

$$P = P_o [P_{ZIP} + P_{EX1} + P_{EX2}], \quad (10)$$

where,

$$P_{ZIP} = p_1 \bar{V}^{-2} + p_2 \bar{V} + p_3, \quad (11)$$

$$P_{EX1} = p_4 (\bar{V})^{a1} (1 + k_{pf1} \Delta f), \quad (12)$$

$$P_{EX2} = p_5 (\bar{V})^{a2} (1 + k_{pf2} \Delta f), \quad (13)$$

$$Q = Q_o [Q_{ZIP} + Q_{EX1} + Q_{EX2}], \quad (14)$$

$$Q_{ZIP} = q_1 \bar{V}^{-2} + q_2 \bar{V} + q_3, \quad (15)$$

$$Q_{EX1} = q_4 (\bar{V})^{b1} (1 + k_{qf1} \Delta f), \quad (16)$$

$$Q_{EX2} = q_5 (\bar{V})^{b2} (1 + k_{qf2} \Delta f) \quad (17)$$

#### 4.1.23.1.2 Modelling of dynamic loads

Induction (asynchronous) motors represent the widely used dynamic loads. Typically, asynchronous motors dissipated 50% to 70 % of the total power system energy [23](Kundur et al., 1993). Fig.23 shows the asynchronous machine equivalent circuit referred to the machine stator side.

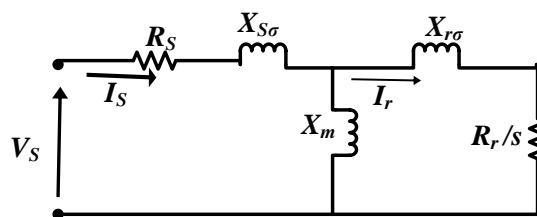

Fig.32: Equivalent circuit referred to stator of the asynchronous machine

In Fig.32,  $S$  is the slip speed of the machine. The typical value of asynchronous machine running slip ranges between 0 to 3.0% (Kamel and Nagasaka, 2015)[21], and (Kamel, 2014) [24].

The initial value of the injected fault current by the induction machine (rotating load) is approximately equal to the machine locked rotor current. For the balanced fault (three phase fault), the mathematical equation which estimates the contribution of the asynchronous machine is given as follows (Kamel and Nagasaka, 2015) [21], and (Morren and de Haan, 2007)[ 25]:

$$i(t) = \frac{\sqrt{2}V_s}{X_s^-} [e^{-\frac{t}{\tau_s^-}} \sin(\alpha) - (1 - \sigma)e^{-\frac{t}{\tau_r^-}} e^{j\omega t} \sin(\omega t + \alpha)], \quad (18)$$

where,

$\alpha$  is the voltage phase angle at the instant of fault occurrence.

$\sigma$  is the flux leakage factor,

$X_s^- = \omega L_s^-$  is the transient reactance of asynchronous machine stator.

$\tau_s^-$  and  $\tau_r^-$  are the machine stator and rotor time constants, and

$\omega$  is frequency in radians per second.

The transient reactance  $\bar{X}_s$  and  $\bar{X}_r$  of the machine stator and rotor can be evaluated as (Kamel and Nagasaka, 2015), (Morren and de Haan, 2007), and (Sulawa et al., 2007):[21], [25], and [26]:

$$\bar{X}_s = X_{s\sigma} + \frac{X_{r\sigma} X_m}{X_{r\sigma} + X_m}, \quad (19)$$

$$\bar{X}_r = X_{r\sigma} + \frac{X_{s\sigma} X_m}{X_{s\sigma} + X_m} \quad (20)$$

The transient time constants for stator and rotor and leakage factors are given by (Kamel, 2014) [24]:

$$\tau_s^- = \frac{L_s^-}{R_s}, \quad (21)$$

$$\tau_r^- = \frac{L_r^-}{R_r}, \quad (22)$$

$$\sigma = 1 - \frac{L_m^2}{L_s L_r}, \quad (23)$$

$$L_s = L_{s\sigma} + L_m \text{ and } L_r = L_{r\sigma} + L_m \quad (24)$$

According to (Kamel and Nagasaka, 2015)[21], the asynchronous machine peak fault current is estimated as:

$$i_{s,\max} = \frac{\sqrt{2}V_s}{X_s} \left[ e^{-\frac{T}{2\tau_s}} + (1-\sigma)e^{-\frac{T}{2\tau_r}} \right], \quad (25)$$

Where  $T$  is the period time and is equal to reciprocal of  $f$  and  $f$  is the frequency of the grid (50 Hz).

From equation (25), the parameters of the machine are the dominant factors effecting the injected fault current by the dynamic load.

#### **4.23.2 PV interfacing inverter model**

Fig.2 (1.b) shows the configuration of the investigated distribution network. As shown, the PV bus (bus 3) is connected to the network through inverters. During a fault event, the interfacing inverter behaves totally different than the synchronous machine in the classical power grid. The synchronous machine feeds very high fault current, near 500% to 700% of its rated (full load) current (Kamel, 2014)[24]. On the other hand, the interfacing inverter contains a current limiter to protect the inverter switches from the high fault current (Morren and de Haan, 2007) [25]. The fault current of an inverter interfaced PV ranges from 110% to 200% of the rated current (Boutsika and Papathanassiou, 2008)[27]. In this paper, the PV inverters are represented by variable virtual impedances, which limit the fault currents to 200 % of the inverters' rated current (Abdel-Salam et al., 2012) [28].

#### **5.4 Protective impedance relay performance during both balanced and unbalanced faults**

The most important protective relay in the power system is the distance relay. The distance relay measures the impedance by dividing the measured voltage over the measured current at the relay place and is subsequently called impedance relay.

#### 5.14.1 Principles of the protective impedance relay

Fig.45 shows the principle of operation of the protective impedance relay. The relay divides the relay measured voltage ( $V_{Relay}$ ) by the relay measured current ( $I_{Relay}$ ) (Fig.43). During normal operation (Fig.54.a), the relay impedance is very high ( $Z_{Relay} = Z_L + Z_{Load}$ ). During a fault event (Fig.54.b), the load impedance is short circuited and the relay measures very low impedance.

#### 5.24.2 Protective impedance relay reading during all fault types

In the following subsections, the readings of the protective impedance relay during symmetrical (three phase) fault and unsymmetrical (single line to ground, double lines to ground and line to line) faults will be analyzed.

##### 4.2.1 Impedance relay reading under phase faults neglecting fault resistance ( $R_f = 0$ )

The phase faults include the three phase and the phase to phase faults. During those fault types, the earth is not a part of the circuit. The reading of the impedance relay is calculated by dividing the two faulty phase voltages over the two faulty phase current (Tleis, 2019), (Anderson, 1995), (Xu et al., 2010), and (Tseng et al., 2003) [29-32]. During phase to phase fault, and three line to ground fault, the voltage and current can be estimated as in table 1 (Tleis, 2019)[29].

Table 1: voltages and currents during line to line and three line to ground faults (Tleis, 2019) [29]

Fault Quantity	Three lines to ground fault (A-B-C)	Line to Line fault (B-C)

$I_A$	$I^+$	0
$I_B$	$a^2 I^+, a^2 = 1 \angle 240$	$(a^2 - a) I^+, a = 1 \angle 120$
$I_C$	$a I^+$	$(a - a^2) I^+$
$V_A$	$Z_L^+ I^+$	$2(Z_S^+ + Z_L^+) I^+$
$V_B$	$a^2 Z_L^+ I^+$	$(2a^2 Z_L^+ - Z_S^+) I^+$
$V_C$	$a Z_L^+ I^+$	$(2a Z_L^+ - Z_S^+) I^+$

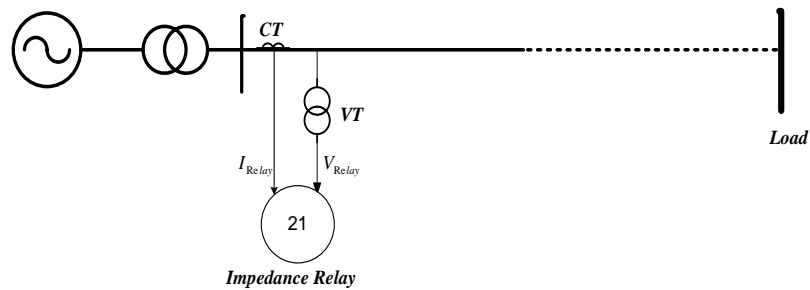

Fig.43: Principles and location of the impedance relay

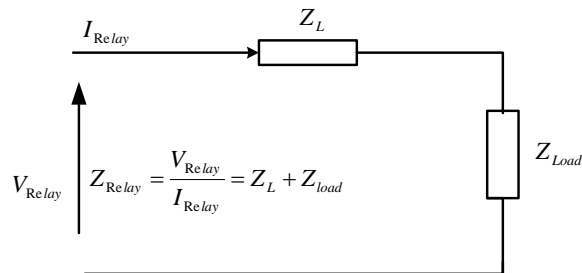

Fig.54.a: Protective impedance relay during normal conditions

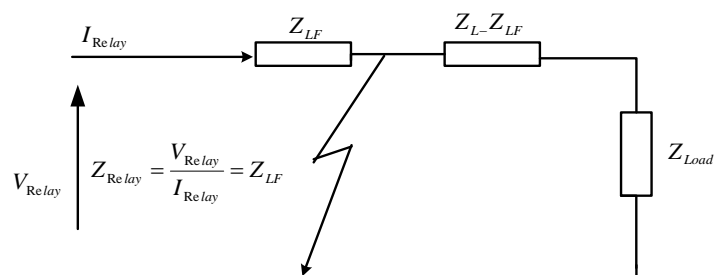

Fig.54.b: Protective impedance relay during fault

#### 4.2.1.1 Protective impedance relay reading during line to line faults (phase B to phase C)

The relay reading is calculated as follows [29](Tleis, 2019):

$$Z_{\text{Relay}} = \frac{V_{BC}}{I_{BC}} \quad (26)$$

From table 1,  $Z_{\text{Relay}}$  is equal to:

$$Z_{\text{Relay}} = \frac{V_{BC}}{I_{BC}} = \frac{V_B - V_C}{I_B - I_C} = \frac{2(a^2 - a)Z_{LF}^+ I^+}{(a^2 - a)I^+} = Z_{LF}^+ \quad (27)$$

#### 4.2.1.2 Protective impedance relay reading during three line to ground faults (A-B-C)

The relay reading is calculated as:

$$Z_{\text{Relay}} = \frac{V_{AB}}{I_{AB}} \quad (28)$$

From table 1,  $Z_{\text{Relay}}$  is equal to:

$$Z_{\text{Relay}} = \frac{V_{AB}}{I_{AB}} = \frac{V_A - V_B}{I_A - I_B} = \frac{Z_{LF}^+ I^+ - a^2 Z_{LF}^+ I^+}{I^+ - a^2 I^+} = Z_{LF}^+ \quad (29)$$

From equation (27-29), the protective impedance relay reading is equal to the positive sequence line impedance from the relay position until the short circuit location.

#### 4.2.2 Protective impedance relay reading under phase faults considering the resistance of the fault ( $R_f \neq 0$ )

Fig.56.a, and Fig.65.b show three lines and line to line short circuit considering the resistance of the fault. The relay reading in existence of fault resistance can be calculated as (Nikolaidis et al., 2018)[33]:

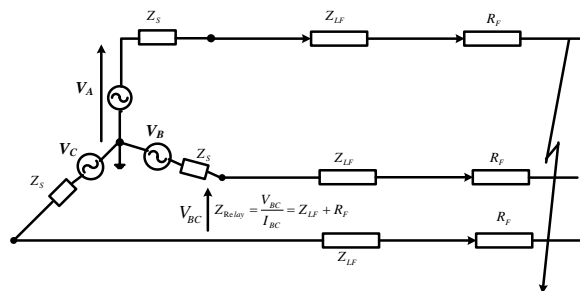

Fig.65.a: Three phase fault with  $R_F$

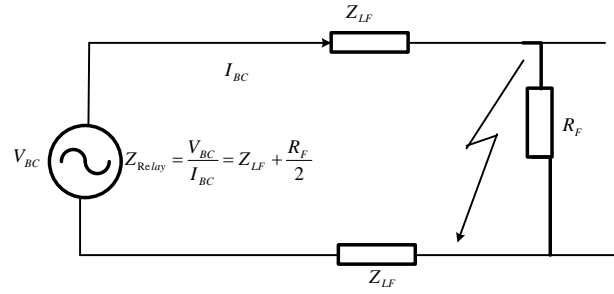

Fig.65.b: line to line short circuit considering  $R_F$

#### 4.2.2.1 Line to line fault (B-C) considering the resistance of the fault ( $R_F \neq 0$ )

The relay impedance during phase to phase fault in existence of fault resistance can be estimated by (Tleis, 2019)[29]:

$$Z_{Relay} = \frac{V_{BC}}{I_{BC}} = Z_{LF}^+ + \frac{R_F}{2} \quad (30)$$

#### 4.2.2.2 Three line to ground fault (A-B-C) ( $R_F \neq 0$ )

The relay impedance during three phase (balanced) fault in existence of the  $R_F$  in series with each phase (Fig.56.a) can be estimated by (Tleis, 2019)[29]:

$$Z_{Relay} = \frac{V_{AB}}{I_{AB}} = Z_{LF}^+ + R_F \quad (31)$$

### 4.2.3 Protective impedance relay reading during earth fault

The earth fault includes single line to ground and double lines to ground faults. During those two faults, the earth is apart from the circuit. Single phase to ground faults are the most common faults in the power system especially the distribution system. In the other side, double phase to ground faults rarely occur. Based on this fact, this paper investigates and highlights single phase to ground faults.

#### 4.2.3.1 Single line to ground fault neglecting fault resistance ( $R_f = 0$ )

Fig.67 represent schematic diagram of the single line to ground fault neglecting the fault resistance ( $R_f = 0$ ). The relay impedance can be calculated as follows (Tleis, 2019)[29]:

$$Z_{\text{Relay}} = \frac{V_A}{I_A} = Z_{LF} \quad (32)$$

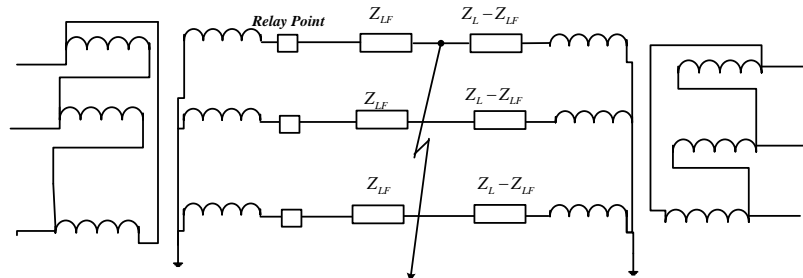

Fig.67: Solid ground single line to ground fault ( $R_f = 0$ )

#### 4.2.3.2 Single line to ground fault considering $R_f$ ( $R_f \neq 0$ )

Fig.78.a shows single line to ground fault in existence of  $R_f$ . Fig.78.b indicates its equivalent circuit.

The impedance relay reading can be calculated by (Tleis, 2019) [29]:

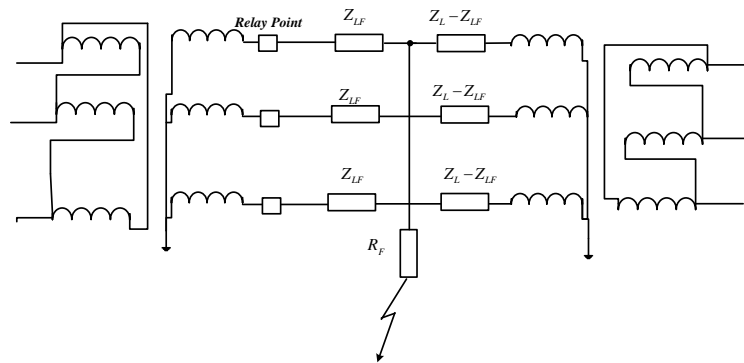

Fig.78.a: Single line to ground fault with fault resistance

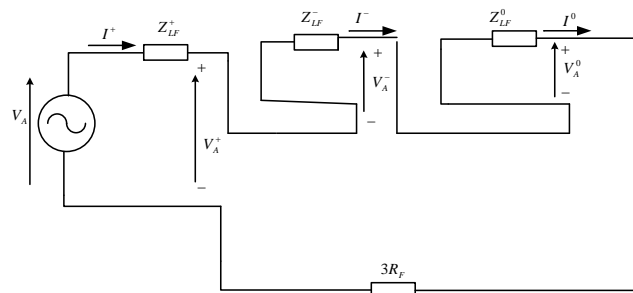

Fig.78.b: Equivalent circuit of single line to ground fault considering fault resistance



The faulty phase (phase A) voltage is given by (Tleis, 2019)[29]:

$$V_A = Z_{LF}^+ I^+ + Z_{LF}^- I^- + Z_{LF}^0 I^0 \quad (33)$$

The short circuit current is given by:

$$I_A = I^+ + I^- + I^0, \quad (34)$$

$$I^+ = I^- = I^0, \quad (35)$$

$$I_N = I_A + I_B + I_C = I_A = 3I^0 \quad (36)$$

It is known that  $Z_{LF}^+ = Z_{LF}^-$ . Defining constant  $K$  equal to:

$$K = \frac{Z_{LF}^0}{Z_{LF}^+} \quad (37)$$

From equations (33), (34), (36), and (37), the faulty phase voltage can be estimated as:

$$V_A = Z_{LF}^+ (I_A + (I_A + I_B + I_C) * \frac{(K-1)}{3}) \quad (38)$$

The impedance relay reading can be calculated by dividing  $V_A$  over  $I_A$  as follow (Tleis, 2019)[29]:

$$Z_{Relay} = \frac{V_A}{I_A} = (1 + \frac{K-1}{3}) Z_{LF}^+ \quad (39)$$

## 6.5. Results and discussions

To indicate the effect of both load type and PVDG on the protective impedance relay reading and setting, the investigated distribution network in (Fig.12) is exposed to a single line to ground fault (the most common type in the distribution system) and three-lines to ground fault (the most severe fault), at the PV bus (bus3) then at the load bus (bus2). Four different main cases and 120 subcases are studied as follows:

- 1) Main case (1) includes 30 subcases, single line to ground fault at PV bus (bus3) with and without PV, different percentages of dynamic load, and different values of  $R_F$ . The main case (1) and its subcases are indicated in table (2)

- 2) Main case (2) likes main case (1) except that three-line to ground fault instead of single line to ground fault occur at PV bus (bus3).
- 3) Main case (3) is like main case (1) except that the fault location is at load bus (bus2) instead of PV bus (bus3).
- 4) Main case (4) is like main case (2) except that the fault location is at load bus (bus2) instead of PV bus (bus3).

The following results indicate the effects of load types (for all cases) and PVDG on the protective impedance relay reading and setting at all main studied cases and subcases.

Table 2: Studied main case (1) and its subcases

Fault resistance	Single line to ground fault at PV bus (bus 3)					
$R_F = 0$ ohm	Without PV			With PV		
	25 %	50 %	90 %	25 %	50 %	90 %
	dynamic load	dynamic load	dynamic load	dynamic load	dynamic load	dynamic load
$R_F = 0.17$ ohm	Without PV			With PV		
	25 %	50 %	90 %	25 %	50 %	90 %
	dynamic load	dynamic load	dynamic load	dynamic load	dynamic load	dynamic load
$R_F = 0.3$ ohm	Without PV			With PV		
	25 %	50 %	90 %	25 %	50 %	90 %
	dynamic load	dynamic load	dynamic load	dynamic load	dynamic load	dynamic load

$R_F = 0.9\text{ohm}$	Without PV			With PV		
	25 % dynamic load	50 % dynamic load	90 % dynamic load	25 % dynamic load	50 % dynamic load	90 % dynamic load
$R_F = 1.3\text{ohm}$	Without PV			With PV		
	25 % dynamic load	50 % dynamic load	90 % dynamic load	25 % dynamic load	50 % dynamic load	90 % dynamic load

**6.4.5.1 Single line to ground fault at PV bus under different dynamic load percentages with and without PV (different  $R_F$ )**

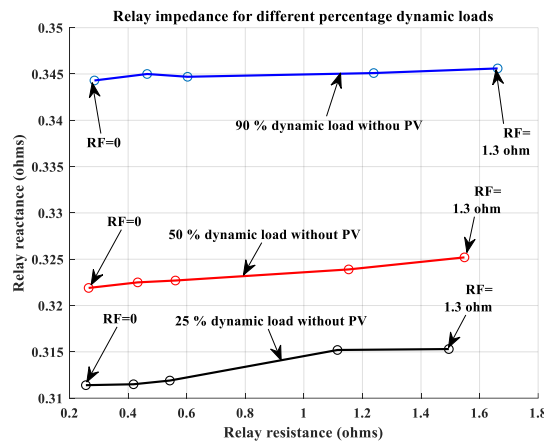

Fig.98: Relay impedance at different dynamic load percentages without PV

Fig.89 shows the protective impedance relay resistance and reactance for different percentages of dynamic loads (90 %, 50%, and 25 %) without the PV plant. As shown, the relay impedance (especially reactance) decreases with decreasing of the dynamic load percentage. For example, at  $R_F = 1.3 \Omega$ , if the dynamic load percentage decreases from 90% to 25%, the relay reactance and resistance decrease from  $0.3456\Omega$  and  $1.6617\Omega$  to  $0.3153\Omega$  and  $1.4950\Omega$ , respectively. This can be interpreted as follow: Increasing the dynamic load percentage will increase the fault current  $I_{23}$

(Fig.12.b), and consequently increase the voltage at bus2 (relay location). Consequently, the relay impedance increases. This phenomenon is correct for all values of  $R_f$ . When the dynamic load percentage decreases from 90% to 25%, for  $R_f=0$  (solid grounded fault), the relay reactance and resistance decrease from  $0.3443\Omega$  and  $0.2849\Omega$  to  $0.3114\Omega$  and  $0.2557\Omega$ , respectively.

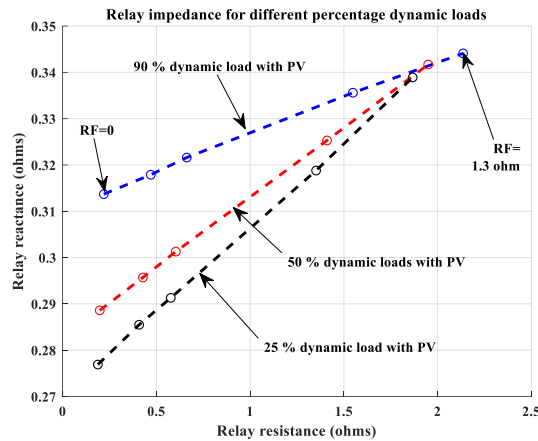

Fig.910: Relay resistance and reactance for different dynamic load percentages with PV

Fig.910 shows the relay resistance and reactance for different dynamic load percentages while considering the PV plant fault current. Also, the relay impedance (both resistance and reactance) increase with increasing the dynamic load percentage in existence of PV plant. For  $R_f=0\Omega$ , the impedance relay resistance and reactance increase from  $0.1877\Omega$  and  $0.2769\Omega$  to  $0.219\Omega$  and  $0.3137\Omega$ , respectively. This phenomenon is valid only for small value of the  $R_f$  ( $R_f=0, 0.17, 0.3$ , and  $0.9\Omega$ ) as shown in Fig.910. As the  $R_f$  increases ( $R_f=1.3\Omega$ ), the dynamic load percentage has a negligible effect on the relay impedance.

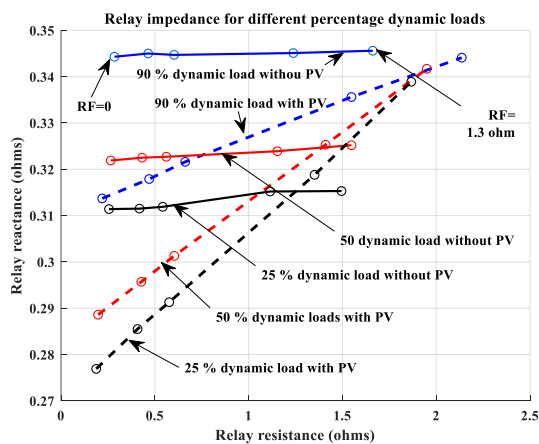

Fig.110: Relay impedance with different dynamic load percentages and different  $R_F$  with and without PV for SLG fault at PV bus (bus3)

Fig.101 combines the results of both Fig.98 (without PV) and Fig.910 (with PV). As shown, existence of PV reduces the impedance (resistance and reactance) of the relay. The injected fault current by the interfacing inverter of the PV plant increases the total fault current. Consequently, the relay impedance decreases ( $Z_{Relay} = \frac{V_2}{I_{23}}$ ). For example, for 90% dynamic loads and  $R_F = 0 \Omega$ , the relay resistance and reactance decreases from  $0.2849\Omega$  and  $0.3443 \Omega$  (without PV plant) to  $0.2195\Omega$  and  $0.3137\Omega$  (with PV), as shown in Fig.110. This phenomenon is valid for small value of  $R_F$ . As the  $R_F$  increases, the injected fault current by the PV plant has small effect in the relay reading.

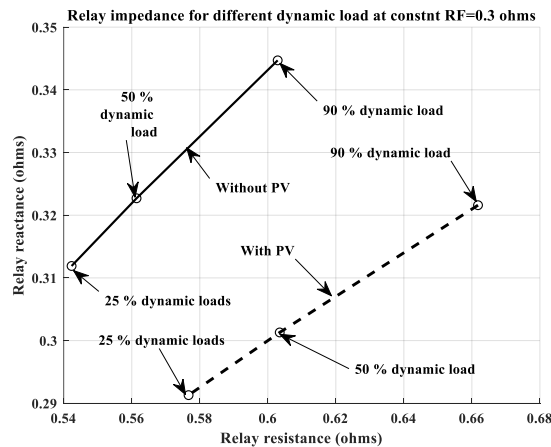

Fig.11: Relay impedance with different dynamic load percentage and constant  $R_F$  with and without PV

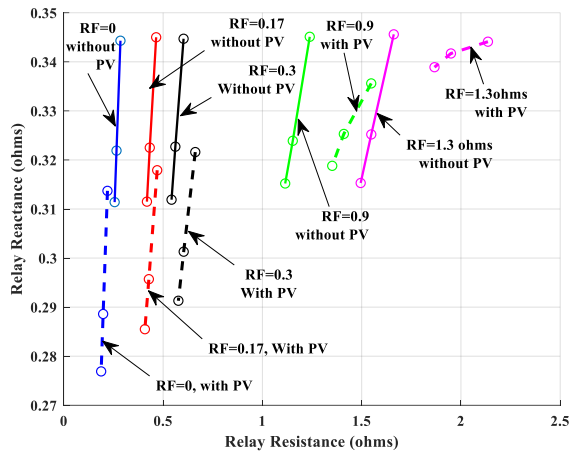

Fig.1212: Relay impedance with different dynamic load percentages and different  $R_F$  ( $R_F = 0$  to  $R_F = 1.3$  ohm) with and without PV for SLG fault at PV bus (bus3).

Fig.11 and Fig.12 112 displays the effects of dynamic load percentage on the impedance relay resistance and reactance at constant  $R_F$  without and with considering the PV plant. As shown, the relay impedance increases with the increase of dynamic load percentages for the same fault resistance with and without considering the PV plant. For high  $R_F$ , the existence of the PV plant has a small effect on the relay reading.

### 6.25.2 Three line to ground fault at PV bus for different dynamic loads percentages with and without PV (different values of $R_F$ )

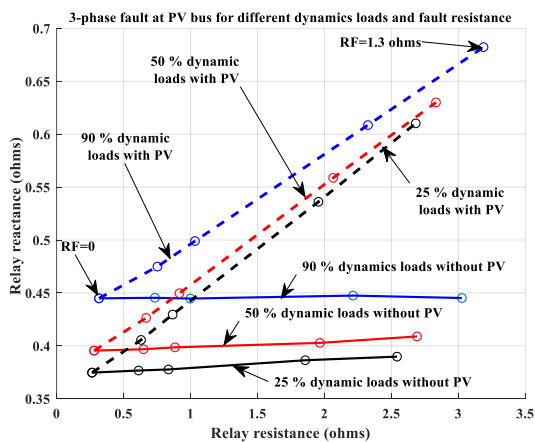

Fig.133: Impedance relay reading for 3-phase fault at PV bus for different percentages of dynamic load and  $R_f$  with and without PV

Fig.133 shows the relay reading for three line to ground fault at bus 3 with and without PV under different percentage of dynamic load and different values of  $R_f$ . As shown, the dynamic load increases the resistance and reactance of the protective impedance relay. The injected fault current by the dynamic load flows through the line from bus 2 to bus 3 and flows through the fault resistance ( $R_f$ ). This increases the voltage at the relay location (bus2), and consequently increases the relay impedance as shown in Fig.133. Without existence of the PV plant, the relay impedance for 90% dynamic load (solid blue line) is larger than its value for 25% dynamic load (solid black line).

With considering the PV plant, the injected fault current by the PV plant flows through the fault resistance and increases the voltage at the relay location (bus2). The relay impedance increases with the existence of the PV plant. For 90% dynamic load and fault resistance  $R_f = 1.3\Omega$ , the relay resistance and reactance increase from  $3.0259 \Omega$  and  $0.4452 \Omega$  (without PV) to  $3.1877\Omega$  and  $0.6822 \Omega$  (with PV), respectively.

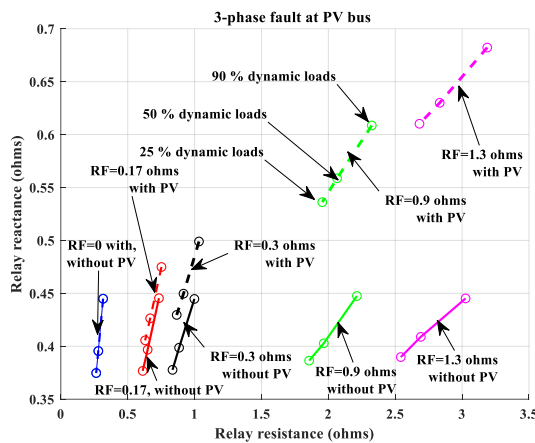

Fig.154: Relay impedance for 3-line to ground fault at PV bus (bus 3) for constant  $R_f$

Fig.144 shows the effect of fault resistance on the relay impedance at different dynamic loads with and without the PV plant. As shown, for a high fault resistance ( $R_f$ ), the PV plant has dominant effect

on the protective relay impedance (Fig.144, violet lines solid and dashed). For small value of  $R_F$ , both the percentage of dynamic load and the PV plant has a negligible effect in the protective relay reading (Blue lines in Fig.144).

### 6.3.5.3 Single line to ground fault at load bus for different dynamic load percentages with and without PV (different $R_F$ )

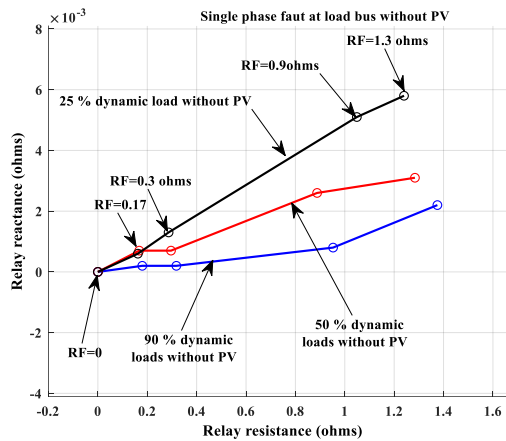

Fig.155: Single line to ground fault at load bus for different dynamic load percentage without PV

Fig.155 shows the impedance relay reading during single line to ground fault at load bus (bus2) without PV and for different dynamic load percentages. As shown, unlike the obtained results for single line to ground fault at PV bus (Fig.89), the relay impedance decreases with increasing the dynamic load percentage. When the fault is at load bus (bus2), the increase in the dynamic load percentage increases the fault current only and does not increase the relay voltage ( $V_2$ ). Consequently, the relay impedance decreases with the increasingly dynamic load percentage. For example, when the dynamic load percentage increases from 25% to 90%, the resistance and reactance of the relay decreases from 1.0488Ω and 0.0051Ω to 0.9526Ω and 0.0008Ω, respectively. This phenomenon is valid for all values of  $R_F$ .

Fig.16 shows the relay resistance and reactance for single phase to ground fault at load bus, different dynamic loads with considering the PV plant. The increasing in the dynamic load percentage decreases the relay impedance in existence of the PV plant.



Fig.17 combines both Fig.155 and Fig.166 to investigate the effect of the PV plant on the impedance relay reading during single line to ground fault occurrence far from the PV plant bus (load bus). As shown in Fig.12.b, when the fault occurs at the load bus (bus 2), the PV injects fault current ( $I_{32}$ ). This current flows in the line between PV bus (bus3) and fault bus (bus 2) causing an improvement to the load bus voltage ( $V_2$ ) which increases the relay impedance. For example, at 90% dynamic load (blue lines in Fig.177) and  $R_F = 1.3 \Omega$ , the relay resistance and reactance increase from  $1.375\Omega$  and  $0.0022\Omega$  (without PV) to  $1.5745\Omega$  and  $0.0726\Omega$  (with PV), respectively.

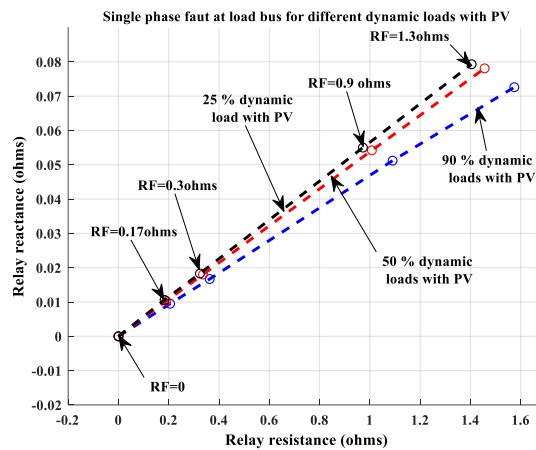

Fig.1616: Single line to ground fault at load bus for different dynamic loads with PV

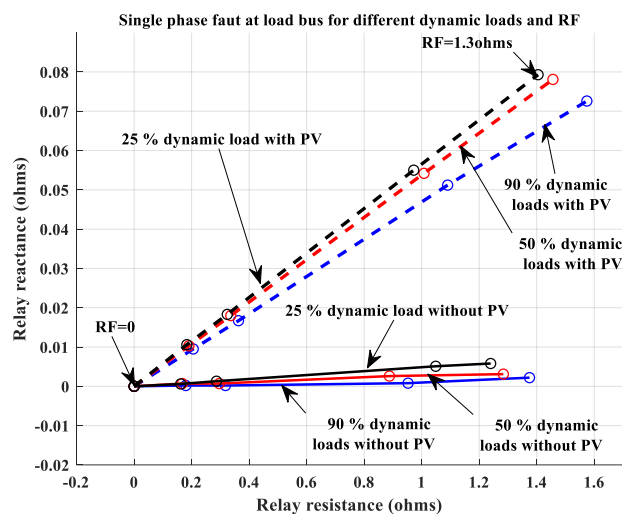

Fig.1717: Single line to ground fault at load bus for different percentages of dynamic load and different  $R_F$  with and without PV

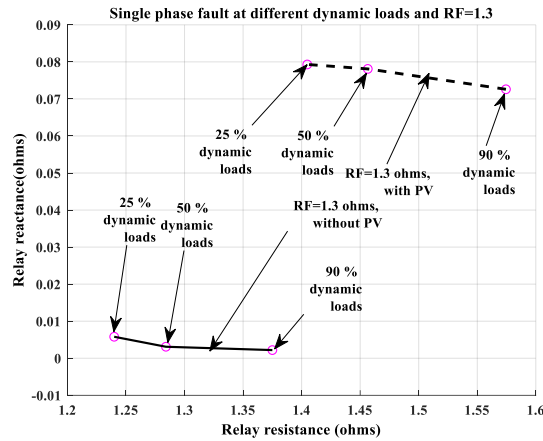

Fig.1818: Single line to ground fault at load bus with different percentages of dynamic loads, and constant  $R_F$  ( $R_F = 1.3 \Omega$ ), with and without PV.

Fig.18 18 indicates the effect of both dynamic load percentages and PV plant on the relay reading for constant  $R_F$  ( $R_F = 1.3 \Omega$ ). The PV plant has a dominant effect on the protective relay reading (both relay resistance and relay reactance) when the fault resistance is held constant. The dynamic load percentage has a considerable effect only on the relay resistance, and a negligible effect on the relay reactance.

#### 6.45.4 Three line to ground fault at load bus with different dynamic load percentages with and without PV (different $R_F$ )

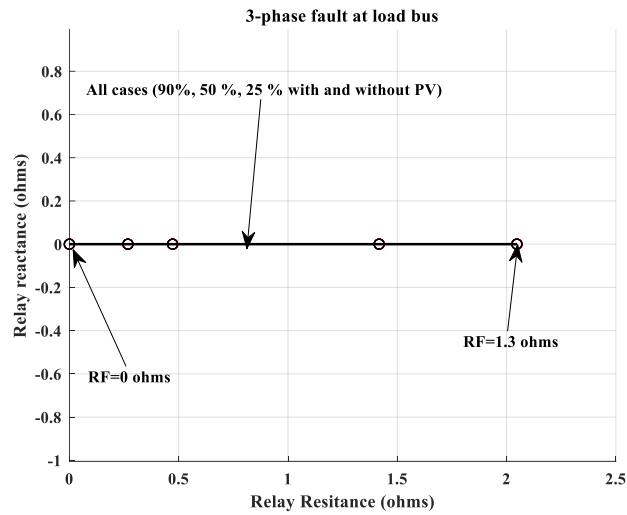

Fig.199: Relay impedance for 3-phase fault at load bus (all cases)

Fig.1919 displays the relay resistance and relay reactance for three line to ground fault at load bus (relay location). As shown, for all cases, the relay reactance equal to zero. The relay has resistance only which depends on the fault resistance ( $R_F$ ) where  $V_2 = I_{SC} R_F$ . For three-phase fault at the relay bus, both the dynamic load percentage and the PV plant have no effect on the relay reading. With other words, the relay reading is only dependent on the fault resistance ( $R_F$ ) for three phase symmetrical fault at its location.

## **8.6. Conclusions**

This paper investigates in detail the effects of both dynamic load percentages and PV plant on the reading and setting of the protective impedance relay. Both balanced (three lines to ground) and unbalanced (single line to ground) faults at different buses (PV bus and load bus) are analyzed. If the fault occurs at the PV system's bus when no PV power is generated (during night), the dynamic load increases the relay impedance, while connecting the PV decreases the relay impedance. The resistance and reactance of the relay increase from  $0.3153\Omega$  and  $1.4950\Omega$ , to  $0.3456\Omega$  and  $1.6617\Omega$  respectively when the dynamic load increases from 25% to 90% of the total load. The resistance and reactance of the relay decrease from  $0.2849\Omega$  and  $0.3443\Omega$  (without PV plant), to  $0.2195\Omega$  and  $0.3137\Omega$  (with PV), respectively. When the dynamic load percentage increases from 25% to 90%, the resistance and reactance of the relay decrease from  $1.0488\Omega$  and  $0.0051\Omega$ , to  $0.9526\Omega$  and  $0.0008\Omega$ , respectively. This phenomenon is valid for all expected fault resistances. When considering constant dynamic load percentage and constant fault resistance, the relay resistance and reactance increase from  $1.375\Omega$  and  $0.0022\Omega$  (without PV) to  $1.5745\Omega$  and  $0.0726\Omega$  (with PV), respectively. Based on those results, the impedance relay setting must be adjusted according to the percentage of the dynamic loads, the PV penetration level, and the fault location. When single line to ground fault occurs at the PV bus (far from relay location), the dynamic loads increase the relay impedance while the PV plant decreases the relay impedance. When a single phase to ground fault occurs at the relay bus (load bus), the dynamic load decreases the relay impedance and the PV plant increases it. For a three-phase to ground fault at the relay bus, both dynamic load percentages and PV plant power generation have no effect on the protective relay impedance readings. At this condition, the relay impedance totally depends on the fault resistance. The main finding conclusion of this paper is that both the load type (especially dynamic load) and the PV plant have dominant considerable effects on the protective impedance relay reading and setting. The distribution system planners and operators must consider the PV plant and types of load during designing, setting and adjusting the protective impedance relays.



## References

- Abdel-Salam, M., Ahmed, A., Ziedan, H., Kamel, R., Sayed, K., Amery, M., Swify, M., 2012. Analysis of protection system for a microgrid supplying irrigation load in Toshka Area, in: IECON 2012 - 38th Annual Conference on IEEE Industrial Electronics Society. pp. 5602–5606. <https://doi.org/10.1109/IECON.2012.6389009>
- Abdullah, H., Kamel, R., El-Sayed, M., 2016. Design and Analysis of 10MWp Grid Connected PV System Installed West Kuwait. 32nd Eur. Photovolt. Sol. Energy Conf. Exhib. 2055–2063. <https://doi.org/10.4229/EUPVSEC20162016-5BV.2.68>
- Anderson, P.M., 1995. Analysis of Faulted Power Systems. Wiley-IEEE Press.
- Boutsika, T.N., Papathanassiou, S.A., 2008. Short-circuit calculations in networks with distributed generation. *Electr. Power Syst. Res.* 78, 1181–1191. <https://doi.org/https://doi.org/10.1016/j.epsr.2007.10.003>
- Bracale, A., Caramia, P., Carpinelli, G., Di Fazio, A.R., 2017. Modeling the three-phase short-circuit contribution of photovoltaic systems in balanced power systems. *Int. J. Electr. Power Energy Syst.* 93, 204–215. <https://doi.org/https://doi.org/10.1016/j.ijepes.2017.05.032>
- Chen, L.-H., 2017. Overcurrent protection for distribution feeders with renewable generation. *Int. J. Electr. Power Energy Syst.* 84, 202–213. <https://doi.org/https://doi.org/10.1016/j.ijepes.2016.05.003>
- Concordia, C., Ihara, S., 1982. Load Representation in Power System Stability Studies. *IEEE Trans. Power Appar. Syst.* PAS-101, 969–977. <https://doi.org/10.1109/TPAS.1982.317163>
- Darwish, A., Abdel-Khalik, A.S., Elserougi, A., Ahmed, S., Massoud, A., 2013. Fault current contribution scenarios for grid-connected voltage source inverter-based distributed generation with an LCL filter. *Electr. Power Syst. Res.* 104, 93–103. <https://doi.org/https://doi.org/10.1016/j.epsr.2013.06.020>
- Eltawil, M.A., Zhao, Z., 2010. Grid-connected photovoltaic power systems: Technical and potential problems—A review. *Renew. Sustain. Energy Rev.* 14, 112–129. <https://doi.org/https://doi.org/10.1016/j.rser.2009.07.015>
- Ghorbani, A., Mozafari, B., Ranjbar, A.M., 2012. Digital distance protection of transmission lines in the presence of SSSC. *Int. J. Electr. Power Energy Syst.* 43, 712–719. <https://doi.org/https://doi.org/10.1016/j.ijepes.2012.05.035>
- Hernández-Callejo, L., Gallardo-Saavedra, S., Alonso-Gómez, V., 2019. A review of photovoltaic systems: Design, operation and maintenance. *Sol. Energy* 188, 426–440. <https://doi.org/https://doi.org/10.1016/j.solener.2019.06.017>
- Ibrahim, D.K., Abo El Zahab, E.E.D., Mostafa, S.A.E.A., 2017. New coordination approach to minimize the number of re-adjusted relays when adding DGs in interconnected power systems with a minimum value of fault current limiter. *Int. J. Electr. Power Energy Syst.* 85, 32–41. <https://doi.org/https://doi.org/10.1016/j.ijepes.2016.08.003>
- IEEE Task Force on Load Representation for Dynamic Performance, 1993. Load representation for dynamic performance analysis (of power systems). *IEEE Trans. Power Syst.* 8, 472–482.

<https://doi.org/10.1109/59.260837>

Iioka, D., Fujii, T., Orihara, D., Tanaka, T., Harimoto, T., Shimada, A., Goto, T., Kubuki, M., 2019. Voltage reduction due to reverse power flow in distribution feeder with photovoltaic system. *Int. J. Electr. Power Energy Syst.* 113, 411–418.

<https://doi.org/https://doi.org/10.1016/j.ijepes.2019.05.059>

Kamel, R.M., 2014. Effect of wind generation system types on Micro-Grid (MG) fault performance during both standalone and grid connected modes. *Energy Convers. Manag.* 79, 232–245.

<https://doi.org/https://doi.org/10.1016/j.enconman.2013.12.009>

Kamel, R.M., Nagasaka, K., 2015. Effect of load type on standalone micro grid fault performance. *Appl. Energy* 160, 532–540. <https://doi.org/https://doi.org/10.1016/j.apenergy.2015.09.044>

Karimi, M., Mokhlis, H., Naidu, K., Uddin, S., Bakar, A.H.A., 2016. Photovoltaic penetration issues and impacts in distribution network – A review. *Renew. Sustain. Energy Rev.* 53, 594–605.

<https://doi.org/https://doi.org/10.1016/j.rser.2015.08.042>

Kim, I.-D., Aggarwal, R.K., 2006. A study on the on-line measurement of transmission line impedances for improved relaying protection. *Int. J. Electr. Power Energy Syst.* 28, 359–366.

<https://doi.org/https://doi.org/10.1016/j.ijepes.2006.01.002>

Kundur, P., 1994. *Power System Stability and Control*, Electric P. ed. (McGraw-Hill, Inc.), New York.

Kundur, P., Rogers, G.J., Wong, D.Y., Yan, A., 1993. *Extended Transient-Midterm Stability Program: Version 3.0. Volume 1, Executive summary: Final report*. Palo Alto, CA, USA.

Madeti, S.R., Singh, S.N., 2017a. Monitoring system for photovoltaic plants: A review. *Renew. Sustain. Energy Rev.* 67, 1180–1207. <https://doi.org/https://doi.org/10.1016/j.rser.2016.09.088>

Madeti, S.R., Singh, S.N., 2017b. A comprehensive study on different types of faults and detection techniques for solar photovoltaic system. *Sol. Energy* 158, 161–185.

<https://doi.org/https://doi.org/10.1016/j.solener.2017.08.069>

Masters, C.L., 2002. Voltage rise: the big issue when connecting embedded generation to long 11 kV overhead lines. *Power Eng. J.* 16, 5-12(7).

Mishra, P., Pradhan, A.K., Bajpai, P., 2021. Adaptive Distance Relaying for Distribution Lines Connecting Inverter-Interfaced Solar PV Plant. *IEEE Trans. Ind. Electron.* 68, 2300–2309.

<https://doi.org/10.1109/TIE.2020.2975462>

Morren, J., de Haan, S.W.H., 2007. Short-Circuit Current of Wind Turbines With Doubly Fed Induction Generator. *IEEE Trans. Energy Convers.* 22, 174–180.

<https://doi.org/10.1109/TEC.2006.889615>

Mortazavi, H., Mehrjerdi, H., Saad, M., Lefebvre, S., Asber, D., Lenoir, L., 2015. A Monitoring Technique for Reversed Power Flow Detection With High PV Penetration Level. *IEEE Trans. Smart Grid* 6, 2221–2232. <https://doi.org/10.1109/TSG.2015.2397887>

Nikolaidis, V., Tsimtsios, A., Safigianni, A., 2018. Investigating Particularities of Infeed and Fault Resistance Effect on Distance Relays Protecting Radial Distribution Feeders With DG. *IEEE Access* 6, 11301–11312.

Soheili, A., Sadeh, J., Bakhshi, R., 2018. Modified FFT based high impedance fault detection

technique considering distribution non-linear loads: Simulation and experimental data analysis. *Int. J. Electr. Power Energy Syst.* 94, 124–140. <https://doi.org/https://doi.org/10.1016/j.ijepes.2017.06.035>

Sorrentino, E., Navas, G., Orea, E., 2018. Effect of an additional large disturbance during power swings on the impedance seen by the out-of-step blocking function. *Int. J. Electr. Power Energy Syst.* 99, 79–84. <https://doi.org/https://doi.org/10.1016/j.ijepes.2017.12.026>

Sulawa, T., Zabar, Z., Czarkowski, D., Birenbaum, L., Lee, S., Ten Ami, Y., 2007. Short Circuit Current of Induction Generators, in: 2007 IEEE International Symposium on Circuits and Systems (ISCAS). pp. 2431–2434. <https://doi.org/10.1109/ISCAS.2007.378611>

Telukunta, V., Pradhan, J., Agrawal, A., Singh, M., Srivani, S.G., 2017. Protection challenges under bulk penetration of renewable energy resources in power systems: A review. *CSEE J. Power Energy Syst.* 3, 365–379. <https://doi.org/10.17775/CSEEJPES.2017.00030>

Tleis, N., 2019. Power systems modelling and fault analysis: Theory and practice, *Power Systems Modelling and Fault Analysis: Theory and Practice*. Elsevier. <https://doi.org/10.1016/C2017-0-02262-0>

Tseng, K.-H., Kao, W.-S., Lin, J.-R., 2003. Load model effects on distance relay settings. *IEEE Trans. Power Deliv.* 18, 1140–1146. <https://doi.org/10.1109/TPWRD.2003.817507>

Xu, Z.Y., Xu, G., Ran, L., Yu, S., Yang, Q.X., 2010. A New Fault-Impedance Algorithm for Distance Relaying on a Transmission Line. *IEEE Trans. Power Deliv.* 25, 1384–1392. <https://doi.org/10.1109/TPWRD.2010.2042082>



- [1] M. Karimi, H. Mokhlis, K. Naidu, S. Uddin, A.H.A. Bakar, Photovoltaic penetration issues and impacts in distribution network – A review, *Renewable and Sustainable Energy Reviews*, Volume 53, 2016, Pages 594-605, ISSN 1364-0321,
- [2] Mohamed A. Eltawil, Zhengming Zhao, Grid-connected photovoltaic power systems: Technical and potential problems—A review, *Renewable and Sustainable Energy Reviews*, Volume 14, Issue 1, 2010, Pages 112-129, ISSN 1364-0321,
- [3] Hernández-Callejo, L., Gallardo-Saavedra, S., Alonso-Gómez, V., 2019. A review of photovoltaic systems: Design, operation and maintenance, *Solar Energy*, 188, pp. 426-440.
- [4] Madeti, S.R., Singh, S.N., 2017b. Monitoring system for photovoltaic plants: A review. *Renew. Sustain. Energy Rev.* 67, 1180–1207.
- [5] C.L.Masters Voltage rise: the big issue when connecting embedded generation to long 11 kV overhead lines *Power Eng J*,16(1)(2002), pp.5-12,
- [6] Daisuke Iioka, Takahiro Fujii, Dai Orihara, Toshio Tanaka, Tsuyoshi Harimoto, Akihiko Shimada, Taichi Goto, Mamoru Kubuki, Voltage reduction due to reverse power flow in distribution feeder with photovoltaic system, *International Journal of Electrical Power & Energy Systems*, Volume 113, 2019, Pages 411-418, ISSN 0142-0615.
- [7] Mortazavi, H., Merjerdi, H., (2015). A monitoring technique for reverse power flow detection with high PV penetration level, *IEE trans. on smart grid*, 6(5): 2221-2232.
- [8] Darwish, A. S. Abdel-Khalik, A. Elserougi, S. Ahmed, and A. Massoud, “Fault current contribution scenarios for grid-connected voltage source inverter-based distributed generation with an LCL filter,” *Electric Power Systems Research*, vol. 104, pp. 93–103, Nov. 2013.
- [9] A. Bracale, P. Caramia, G. Carpinelli, A.R. Di Fazio, Modeling the three-phase short-circuit contribution of photovoltaic systems in balanced power systems, *International Journal of Electrical Power & Energy Systems*, Volume 93, 2017, Pages 204-215,

ISSN 0142-0615,

[10] Elmer Sorrentino, Greta Navas, Emar Orea, Effect of an additional large disturbance during power swings on the impedance seen by the out-of-step blocking function, *International Journal of Electrical Power & Energy Systems*, Volume 99, 2018, Pages 79-84, ISSN 0142-0615,

[11] V. Telukunta, J. Pradhan, A. Agrawal, M. Singh and S. G. Srivani, "Protection challenges under bulk penetration of renewable energy resources in power systems: A review," in *CSEE Journal of Power and Energy Systems*, vol. 3, no. 4, pp. 365-379, Dec. 2017. doi: 10.17775/CSEEJPES.2017.00030

[12] Doaa Khalil Ibrahim, Essam El Din Abo El Zahab, Saadoun Abd El Aziz Mostafa, New coordination approach to minimize the number of re-adjusted relays when adding DGs in interconnected power systems with a minimum value of fault current limiter, *International Journal of Electrical Power & Energy Systems*, Volume 85, 2017, Pages 32-41, ISSN 0142-0615,

<https://doi.org/10.1016/j.ijepes.2016.08.003>.

[13] Li-Hsiung Chen, Overcurrent protection for distribution feeders with renewable generation, *International Journal of Electrical Power & Energy Systems*, Volume 84, 2017, Pages 202-213, ISSN 0142-0615.

[14] Adel Soheili, Javad Sadeh, Reza Bakhshi, Modified FFT based high impedance fault detection technique considering distribution non-linear loads: Simulation and experimental data analysis, *International Journal of Electrical Power & Energy Systems*, Volume 94, 2018, Pages 124-140, ISSN 0142-0615,

<https://doi.org/10.1016/j.ijepes.2017.06.035>

[15] Amir Ghorbani, Babak Mozafari, Ali Mohammad Ranjbar, Digital distance protection of transmission lines in the presence of SSSC, *International Journal of Electrical Power & Energy Systems*, Volume 43, Issue 1, 2012, Pages 712-719, ISSN 0142-0615,

<https://doi.org/10.1016/j.ijepes.2012.05.035>.

[16] Siva Ramakrishna Madeti, S.N. Singh, A comprehensive study on different types of faults and detection techniques for solar photovoltaic system, *Solar Energy*, Volume 158, ,2017, Pages 161-185, ISSN 0038-092X,

[17] Il-Dong Kim, Raj K. Aggarwal, A study on the on-line measurement of transmission line impedances for improved relaying protection, *International Journal of Electrical Power & Energy Systems*, Volume 28, Issue 6, ,2006, Pages 359-366, ISSN 0142-0615.

[18] Abdullah, H., Kamel, R., El Sayed, M. (2016). Design and analysis of 10 MWp grid connected PV system installed west Kuwait, *Proceedings of the 32nd European Photovoltaic Solar Energy Conference and Exhibition*, 2055-2063.

[19] IEEE Task Force Report, "Load Representations for Dynamic Performance Analysis," Paper 92WM126-3 PWRD, Presented at the IEEE PES Winter Meeting, New York, Jan. 26-30, 1992.

[20] Kundur, P. (1994). *Power system stability and control*. McGraw-Hill, New York, ISBN 0-07-035958-X.

[21] Rashad M. Kamel, and Ken Nagasaka, " Effect of load type on standalone micro grid fault performance," *Applied Energy* 160 , pp.532–540, 2015.

[22 ] C. Concordia, S. Ihara, "Load Representations on Power System Stability Studies," *IEEE Trans. Vol. PAS-101*, pp. 969-977, April 1982.

[23] EPRI Report of Project 1208-9, "Extended Transient Midterm Stability Program," Final report, Prepared by Ontario Hydro, Dec. 1992.

[24] Rashad M. Kamel, " Effect of wind generation system types on Micro-Grid (MG) fault performance during both standalone and grid connected modes," *Energy Conversion and Management* Vol.79, pp. 232–245, Jan. 2014.

[25] Morren J, Haan S. Short-circuit current of wind turbines with doubly fed induction generator. *IEEE Trans Energy Conv.* 2007; 11(1).

[26] Sulawa Zabara et al. Short circuit current of induction generators. *IEEE ISCAS 2007 proc.*

- [27] Thekla N. Boutsika and Stavros A. Papathanassiou, "Short-circuit calculations in networks with distributed generation," *Electric Power Systems Research*, Vol. 78, pp. 1181–1191, 2008.
- [28] Mazen Abdel-Salam, Adel Ahmed, and Rashad M. Kamel "Analysis of Protection System for a Microgrid Supplying Irrigation Load in Toshka Area," *IECON' 2012*, ÉTS Montréal, Québec, Canada , pp.5586-5590, Oct. 2012.
- [29] Nasser D. Tleis, "Power Systems Modelling and Fault Analysis," book, 2008.
- [30] Paul M. Anderson, *Analysis of Faulted Power Systems,* book. Wiley-IEEE [8] Press
- [31] Zhen Yu Xu ; G. Xu ; Li Ran , ; S. Yu ; Q. X. Yang , " A New Fault-Impedance Algorithm for Distance Relaying on a Transmission Line," *IEEE Trans. on Power Delivery*, Vol. 25, No. 3 ,pp. 1384 – 1392, July 2010.
- [32] Kuo-Hsiung Tseng ,Wen-Shiow Kao , and Jia-Renn Lin "Load model effects on distance relay settings", *IEEE Transactions on Power Delivery*, Vol. 18 , No. 4 , pp.1140 – 1146, Oct. 2003.
- [33] Vassilis C. Nikolaidis, Aristotelis M. Tsimtsios , and Anastasia S. Safigianni "Investigating Particularities of Infeed and Fault Resistance Effect on Distance Relays Protecting Radial Distribution Feeders With DG", *IEEE Access*, pp.11301 – 11312.