

QATAR UNIVERSITY

Graduate Studies

College of Arts and Sciences

**Chemical Treatment and Characterization of Qatalum's 1<sup>st</sup>  
Cut Spent Spot Lining (SPL)**

A Thesis in  
Materials Science and Technology Program

By  
Omar Aljarod

© 2015 Omar Aljarod

Submitted in Partial Fulfillment

Of the Requirements

For the Degree of

Master of Science

June 2015

## **Declaration**

To the best of my knowledge, this thesis contains no material previously published or written by another person or institution, except where due reference is made in the text of the thesis. This thesis contains no material which has been accepted for the award of any other degree in any university or other institution.

Name: Omar Aljarod

Signature

A handwritten signature in blue ink that reads "Omar Aljarod". The signature is written in a cursive style with a long horizontal stroke extending to the right.

Date 14 / 06 / 2015

## Committee

The thesis of Omar Yosef Aljarod was reviewed and approved by the following:

We, the committee members listed below, accept and approve the thesis of Mr. Omar Yosef Aljarod. To the best of this committee's knowledge, the thesis conforms the requirements of Qatar University, and we endorse this thesis for examination.

Supervisor Dr. Aboubakr A. Ali

Signature  Date 14/06/2015

Name Prof. Mufeed odeh

Signature  Date 14/06/2015

Name Prof. Geir M. Haaberg

Signature  Date 14/06/2015

Name Prof. Hans J. Roven

Signature  Date 14/06/2015

Name Dr. Chris Devadas

Signature  Date 14/06/2015

## **Abstract**

Spent pot lining (SPL) waste is produced in thousands of tons annually from the aluminium production factories including Qatar Aluminum Company, Qatalum. SPL is classified into first and second cut; the first cut is mainly composed of conductive graphite while the second cut consists of refractory insulator bricks. Generally, the 1<sup>st</sup> cut SPL is a hazardous material with contaminants of fluorides, cyanides, lead and chromium in addition to production of flammable gases when it contacts water. The work of this thesis is fully dedicated to characterizing 1<sup>st</sup> cut SPL. The sample was obtained from Qatar Aluminum Company (Qatalum) located in Mesaieed, Qatar. Moreover, 1<sup>st</sup> cut SPL samples were chemically treated for the purpose of extracting graphite that proved to be suitable for heavy metal ions removal from water after being treated to prepare graphene which was functionalized before using it by adding more carboxylate groups to its surface. In principle, the functionalized graphene has shown very high efficiency in copper ions removal from aqueous solutions at different pH values. The highest efficiency was observed at pH value of 7.

## Contents

---

List of Tables .....	vii
List of Figures .....	viii
Acknowledgements.....	ix
Dedication .....	x
1. General introduction.....	1
1.1 Introduction .....	1
1.2 Objectives and Significance .....	2
1.3 Outline of the thesis.....	3
2. Literature Review.....	4
2.1 Literature survey.....	4
2.1.1 Background about aluminum production cell .....	4
2.1.2 Types of Spent Pot Lining.....	9
2.1.3 SPL Ingredients.....	10
2.1.4 SPL Hazards .....	12
2.2 1 <sup>st</sup> Cut SPL Treatment Methods .....	13
2.2.1 Thermal treatment.....	14
2.2.2 Chemical Treatment: Ion Exchange Process .....	22
2.2.3 Gas treatment: VAW Aluminum AG Silica Chlorine Treatment Process.....	24
2.2.4 Hydrometallurgical treatment .....	24
3. Major applications of 1 <sup>st</sup> cut SPL.....	40
3. Materials & Equipment's .....	41
3.1 Materials .....	41
3.1.1 1 <sup>st</sup> Cut SPL.....	41
3.2 Chemicals and Accessories .....	43
3.3 Graphite Extraction.....	43
3.4 Equipment.....	46
3.4.1 CryoMill.....	46

3.4.2	Gas Chromatography/Mass Spectrometry (GC/MS) .....	47
3.4.3	Fourier Transform Infrared Spectroscopy (FTIR) .....	48
3.4.4	Thermogravimetric Analysis (TGA) .....	49
3.4.5	X-ray Diffraction (XRD) .....	50
3.4.6	Scanning Electron Microscopy (SEM) & Energy Dispersive X-ray Spectroscopy (EDX) .....	51
3.4.7	Ion Chromatography (IC).....	53
3.4.8	Inductively Coupled Plasma (ICP) .....	54
4.	Results & Discussion: 1 <sup>st</sup> cut SPL .....	55
4.1	Gas Chromatography/Mass Spectrometry (GC/MS) .....	55
4.2	Fourier Transform Infrared Spectroscopy (FTIR) .....	56
4.3	Thermogravimetric Analysis (TGA) .....	57
4.4	X-ray Diffraction (XRD) .....	59
4.5	Scanning Electron Microscopy (SEM) .....	61
4.6	Energy Dispersive X-ray Spectroscopy (EDX) .....	62
4.7	Ion Chromatography (IC) .....	63
4.8	Inductively Coupled Plasma (ICP) .....	64
5.	Application .....	65
5.1	Graphene as an adsorbent for heavy metals ions removal .....	65
5.2	Materials and Methods.....	66
5.3	Results and Discussion .....	67
6.	Summary and Conclusions .....	70
7.	Future work.....	72
	References .....	73

## List of Tables

---

Table 1: 1 <sup>st</sup> cut SPL ingredient/ History [15,16] .....	10
Table 2: 2 <sup>nd</sup> Cut SPL ingredient/History[15] .....	11
Table 3: Comparison between the efficiency of the different chemical techniques [32] .....	23
Table 4: Hydrometallurgical treatment results by Joseph [33] .....	32
Table 5: Summary types of treatment methods for 1 <sup>st</sup> cut SPL.....	37
Table 6: Collected gases after washing 1 <sup>st</sup> cut SPL with water. ....	55
Table 7: Chemical analysis for 1st cut SPL before and after washing using EDX technique...	62
Table 8: conc. Of F <sup>-</sup> and Cl <sup>-</sup> ions in the washing effluents after several washing cycles for 1 <sup>st</sup> cut SPL using IC technique. ....	63
Table 9: Al <sup>+3</sup> and Na <sup>+</sup> conc. in the washing effluents of 1 <sup>st</sup> Cut SPL .....	64

## List of Figures

---

Figure 1: Schematic diagram for molten Al electrolytic cell.....	7
Figure 2: Laboratory apparatus for thermal hydrolysis of cyanides.....	16
Figure 3: Luc Fortin et al. experimental setup.....	18
Figure 4: Alcoa caustic leaching process flow sheet.....	26
Figure 5: Ion concentration profiles vs. sono-leaching time for carbon powder in pure water .....	34
Figure 6: Ions leached from carbon under ultrasound in □200, ○300 and Δ400 ml of water.....	34
Figure 7: F <sup>-</sup> concentration in leachate after sono-leaching with 50g carbon powder in 500ml water .	34
Figure 8: XRD pattern of inorganic fraction from raw SPL recovered by ashing at 800°C for 5 h. Marked peaks correspond to NaAl <sub>11</sub> O <sub>17</sub> (*), CaF <sub>2</sub> (#) and NaF(l). .....	36
Figure 9: XRD pattern of inorganic fraction from SPL residue after water wash and Al <sup>3+</sup> leach recovered by ashing at 800 °C for 5 h. Marked peaks correspond to NaAl <sub>11</sub> O <sub>17</sub> (*), CaF <sub>2</sub> (#), NaF (l), Na <sub>1.95</sub> Al <sub>1.95</sub> Si <sub>0.05</sub> O <sub>4</sub> (^), Al <sub>2</sub> O <sub>3</sub> (+) and LiAlSi <sub>3</sub> O <sub>8</sub> (-). .....	36
Figure 10: steps of collecting 1st cut SPL samples .....	41
Figure 11: Cryomill machine used for 1 <sup>st</sup> cut SPL grinding. ....	42
Figure 12: Fine powder of 1 <sup>st</sup> cut SPL. ....	42
Figure 13: Collected gases after washing 1 <sup>st</sup> Cut SPL with water. ....	45
Figure 14: summary for the research design and method. ....	45
Figure 15: GC-MS system while testing the evolved gas from 1st cut SPL samples after washing with deionized water.....	47
Figure 16: FTIR instrument that was used to qualitatively analyze the 1 <sup>st</sup> cut SPL samples. ....	48
Figure 17: TGA instrument that was used to measure thermograms for different 1 <sup>st</sup> cut SPL samples	49
Figure 18: X-ray diffractometer that was used in this work. ....	50
Figure 19: SEM&EDX instrument that was used in this work.....	52
Figure 20: Ions Chromatography instrument used in this work.....	53
Figure 21: Inductively Coupled Plasma instrument used in this work. ....	54
Figure 22: FTIR Charts for A) Pure cathode; B) un-washed and C) washed 1 <sup>st</sup> cut SPL .....	56
Figure 23: Thermograms for (A) pure cathode and 1 <sup>st</sup> cut SPL (B) before and (c) after washing.....	58
Figure 24: XRD diffraction patterns (A) unused cathode, (B) unwashed and (C) washed 1 <sup>st</sup> cut SPL....	60
Figure 25: SEM images for (A) pure cathode, (B) washed and (C) unwashed 1 <sup>st</sup> cut SPL.....	61
Figure 26: XRD patterns of (a) graphite, (b) graphene oxide and (c) graphene. ....	67
Figure 27: FTIR of the functionalized graphene. ....	68
Figure 28: Removal of waste (%) for pH 1, 7 and 10 .....	69



## **Acknowledgements**

I would have never been able to finish my thesis without the guidance of my committee members, help from friends, and support from my family.

I would like to express my deepest gratitude to my advisor, Dr. Aboubakr M. Abdullah, for his continuous guidance, caring, patience, and providing me with an excellent atmosphere for doing research. My deepest appreciation goes to Prof. Mariam Al-Maadeed, Director of Center for Advanced materials (CAM) for her everlasting support. Her kind guidance and motivation opened for me the doors to be as creative as possible in all different aspects of my early-career path.

Special thanks go to the project sponsor, Qatar Aluminium Company (Qatalum) for their financial support. Also many thanks are due to Prof. Mufeed Odeh, Dr. Chris Devadas, Prof. Hans Jorgen and Prof. Geir Martin Haarberg for their continuous help and support. My personal appreciation goes to Prof. Mufeed Odeh for arranging the training and visit to Qatalum.

Further, I cannot forget the helpful discussions and valuable suggestions with my sincere colleagues: Eng. Haneen Abdelrazeq, Dr. Yahia Shoeb, Dr. Miroslav Mrlik, Dr. Marketa Ilcikova, Mr. Abdul Jaleel Naushad, Mr. Moinuddin Yusuf, Mr. Abdullah Holozadah Mr. Abdullah Alashraf, Eng. Mohamed Salih and Mr. Ahmed Radwan. They were always there when I needed help. Their encouragement has eased all the obstacles and challenges that I faced during my thesis work.

Also, many thanks goes to Mr. Esam, Mr. Moath and Mr. Fathy from Qatar University's central laboratory unit (CLU) and Mr. Mostafa zagho and Mr. Ahmed solaiman from Qatar University's gas process center (GPC) for their efforts in assisting with the samples' analysis. At the end, I would like to thank Mr. Rosano and Mr. Richard. Their hot and delicious coffee, made my days brighter.

## **Dedication**

I dedicate this thesis to my parents. I hope this achievement makes them proud by completing their dream when devoting the past years in giving me the best education I could have ever dreamed of.

# 1. General introduction

## 1.1 Introduction

Knowing the fact that hydrogen is nobler than aluminum in the electrochemical series, it is impossible to produce aluminum by an aqueous electrolytic process. It was Charles Martin Hall (1863-1914) and Paul Louis Toussaint Héroult (1863-1914) who designed and patented their idea to produce aluminum for molten salt electrolysis in 1886 [1]. Liquid Aluminium is produced by electrochemical reduction of alumina ( $\text{Al}_2\text{O}_3$ ) (~ 6 wt%) which is dissolved in the cryolite ( $\text{Na}_3\text{AlF}_6$ ) electrolyte. The process takes place in an electrolytic cell, namely “pot” that is composed mainly of anode and cathode.

Two main common types of anodes are used: (i) prebaked anodes and (ii) Soderberg anodes [3, 4]. The actual cathode is the reduced aluminium metal at the bottom of the cell; these name are granted for the carbonaceous lining consisting the 1<sup>st</sup> cut; which tops the 2<sup>nd</sup> cut (consisting of the current collector bars, insulators and refractory bricks) [5-8]. After about six years of operation, the carbonaceous material (1<sup>st</sup> cut) becomes contaminated with impurities that affect the purity of the produced Aluminium metal and decreases the efficiency of the Aluminium production process. At such time, the pot must be delined and the carbonaceous layer is called 1<sup>st</sup> cut spent pot lining (1<sup>st</sup> cut SPL) while the refractory bricks and insulators are called 2<sup>nd</sup> cut SPL. Each factory usually produces hundreds of tons of both types of SPL throughout its lifetime of operation.

The treatment or recycling of SPL is one of many challenges facing the aluminum industry because of the high cost of storage and transportation. A first step in finding the best treatment technique for 1<sup>st</sup> cut SPL with suitable application is to know exactly the composition of the material. Aluminum producers create material safety data sheets for their SPL wastes. Qatalum just started to create these sheets since it is a new company in Qatar. In this work, we are characterizing the 1<sup>st</sup> cut SPL generated by Qatalum in order to participate in creating its material safety data sheet (MSDS) at a later date and to assist in the extraction of its carbonaceous component that may be highly suitable for other applications.

## **1.2 Objectives and Significance**

The aim of this study is to bring three main goals to reality: (i) fully characterize the 1<sup>st</sup> cut SPL which is produced by Qatalum to help in creating its MSDS, (ii) extract the graphite component which comprises between 50-60% of Qatalum's 1<sup>st</sup> cut SPL and (iii) use the extracted graphite to prepare graphene oxide which will be converted to reduced graphene oxide "graphene" using modified Hummers' method. The latter will be functionalized to add carboxylate groups to its surface and will be used to remove heavy metal ions from water.

It is worthy to mention that the characterization and the chemical treatment of the 1<sup>st</sup> cut SPL was done on the 1<sup>st</sup> cut SPL (which stayed in the pot around 5 years).

### **1.3 Outline of the thesis**

The outline of this study is as follows:

- Chapter 1: General introduction
- Chapter 2: Literature review
- Chapter 3: Materials and equipment
- Chapter 4: Results and discussion: 1<sup>st</sup> cut SPL
- Chapter 5: Application
- Chapter 6: Summary and Conclusions
- Chapter 7: Future work

## 2. Literature Review

### 2.1 Literature survey

#### 2.1.1 Background about aluminum production cell

Nowadays, the number of aluminum production factories are rapidly growing since aluminum (Al) is one of the highly demanded products worldwide. Al is an element that is located in the 3<sup>rd</sup> group of the periodic table where its atomic number is 13 and atomic mass is 27 amu. Al is produced by an energy demanding two-steps process. The key target of this process is to convert the bauxite (raw materials of aluminum oxide) into pure metal due to the overall reaction 1.

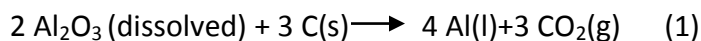

Technically, the two steps take place separately. The first one includes refining of the bauxite raw material which has a 30-60% alumina ( $\text{Al}_2\text{O}_3$ ) to pure alumina [1, 4]. This process is invented by an Austrian chemist named Karl Joseph Bayer, and the process is called under his name: Bayer process. The second reaction is the electrochemical reduction, in which alumina is decomposed into its element, and reduced to molten Al at the cathode and oxygen which reacts with carbon at the anode to form carbon dioxide reaction 1 [2].

Chemists, Charles Martin Hall (1863-1914) and Paul Louis Toussaint Hérault (1863-1914) have designed and patented separately their idea to produce aluminum using fused salt electrolysis in 1886 [2]. Later, their method was named "Hall-Hérault process". The Hall-Hérault process is an example of the Al smelting process that is

used nowadays in industrial processes. Molten Al produced by the electrolytic reduction of alumina that is dissolved in an electrolyte (bath) mainly containing cryolite ( $\text{Na}_3\text{AlF}_6$ ) as shown in equation 1. Cryolite is a rare mineral that was found at the west coast of Greenland. The currently used cryolite is a synthetic one. The basic principle of Hall-Héroult process has remained the same for more than a hundred years but its efficiency has increased due to new technologies [2]. Today, aluminum electrolysis is known to be one of the most efficient technologies (96%).

Hall-Héroult process takes place in an electrolytic cell (also known as “pot”). The pots are usually located in a long row, so called as potlines. The links between pots can be side by side or head to tail. The basics of Al electrolysis are well described by several authors [3-5]. A clarification of a modern cell is shown in Figure 1 which is a schematic showing the electrolytic cell components. It can be seen that the major components are anodes (1), cathodes (12) and electrolyte (3). Details of the pot are shown in the figure caption.

In addition to cryolite and 2-5 wt% of alumina from the Bayer- process, the basin consists of 10-12 wt% Aluminium fluoride ( $\text{AlF}_3$ ) and almost 5 wt% of calcium fluoride ( $\text{CaF}_2$ ) [2]. Instead of  $\text{AlF}_3$ , some plants use other compounds e.g. lithium fluoride ( $\text{LiF}$ ) and/or magnesium fluoride ( $\text{MgF}_2$ ) [3]. The operating temperature is  $950^\circ\text{C}$ . This temperature is important to make the adjustment between different composites e.g. electrical conductivity, current efficiency, alumina and metal solubility, density and vapor pressure [3]. The aforementioned mixture is called the

bath or an electrolyte. Its main function is to act as a solvent for  $\text{Al}_2\text{O}_3$  and enables its electrolytic decomposition to form Al at the cathode and  $\text{CO}_2$  gas at the anode [2]. Holes are located in the crust to feed the alumina. This process is done by a point feeder in 1-2 kg every one to two minutes [5]. The important thing here is to take care while controlling the concentration of the alumina. The "sludge" or "muck" forms when high amounts of undissolved bath/alumina are added [9, 10].



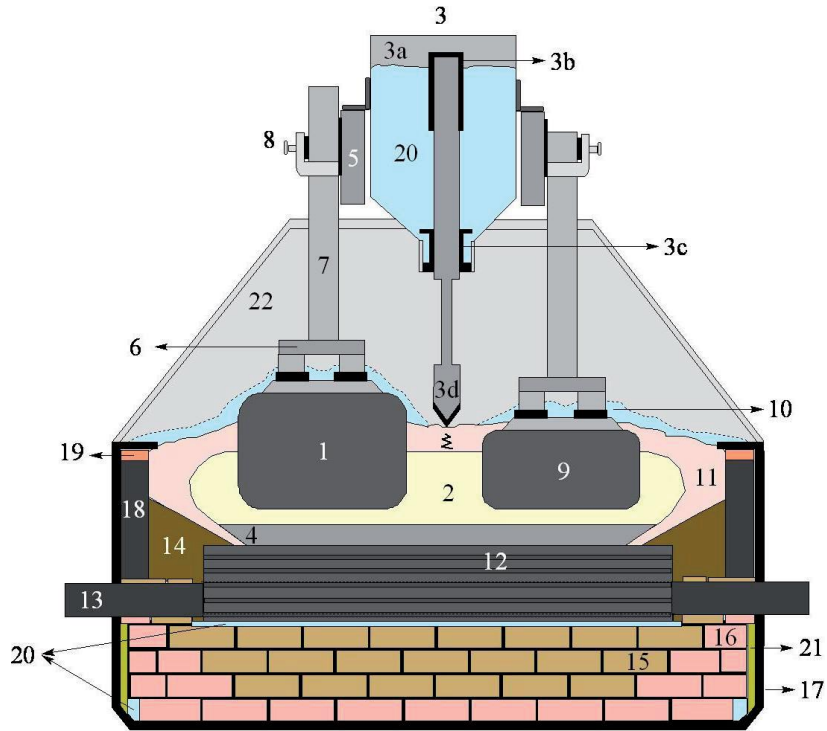

Figure 1: Schematic diagram for molten Al electrolytic cell

(1) anode (prebaked); (2) electrolyte (bath); (3) Alumina point feeder, (3a) alumina hopper (3b) air cylinder, (3c) metering chamber, (3d) crust breaker; (4) aluminium pad; (5) anode beam (current supply); (6) anode yoke and stubs (iron); (7) anode rod (aluminium); (8) anode clamp; (9) spent anode (butt); (10) alumina crust/ cover; (11) crust (side ledge); (12) cathode carbon block; (13) current collector bar (steel); (14) ramming paste; (15) refractory; (16) insulation; (17) steel shell; (18) sidewall block; (19) cast able; (20) alumina; (21) rock wool and (22) gas collection hood (removable).The details in the lining may vary [2].

The design of the bath is almost stable. Its height is around 90 cm and the temperature during the operation is between 950 and 965°C [4]. The anode is made up of carbon and is immersed into the bath from the top. The CO<sub>2</sub> is formed when the oxygen of alumina, which is formed at the anode, reacts with the carbon of the anode. Carbon dioxide gas escapes through the holes in the crust and is collected from the hood.

The used anodes can be divided into two main types; the first type called prebaked anodes which are made of petroleum coke and coal tar pitch. They are molded into blocks at the end. And then baked in separate furnaces and then placed in the cell [5]. Prebaked technology uses multiple anodes in each cell. The other type of anode is called Soderberg anode. This type is considered to be an older technology which is currently replaced by the prebaked one that lowers energy consumption and emissions [5 , 2]. In the Hall-Héroult process, the anode is always consumed and must be replaced every 26 days. It is worthy to mention that the average lifetime of the cell lining was increased from 1000 to 2500 days during the process. This increase took place due to the high quality of materials, new operational procedures, innovations in cell design as well as the process of automation [5].

Within the last decades, the replacement of anthracitic coal with graphitized carbon materials for the cathode was a huge development in terms of the reduction in electrical resistivity and the decrease in the total expansion of average cell lifetime [11]. The refractory layer that was installed below the cathode carbon block caused a uniform distribution of heat. The insulation bricks underneath were designed to

protect the steel pot shell from local corrosion and chemical attack [2, 5]. The refractory materials are mainly composed of alumina-silicates ( $\text{Al}_2\text{O}_3\text{-SiO}_2$ ) [12].

The lifetime of the pot is about six years; during this time the lining absorbs different materials that come from the molten electrolyte [7, 13]. Cracking, erosion or deterioration leads to a decrease in the purity of the aluminium being produced [6]. At this stage, the delining process starts to generate what is called Spent Pot Lining (SPL) [8, 14].

### 2.1.2 Types of Spent Pot Lining

The pot lining as can be seen in Figure 1 (Items 12, 15, 16, 18, 20 and 21) can be classified mainly into 1<sup>st</sup> cut and 2<sup>nd</sup> cut. The 1<sup>st</sup> cut is the cathode which mainly consists of carbonaceous material blocks with graphitized carbon. The role of the 1<sup>st</sup> cut is to conduct electricity. The refractory layer that is located below the cathode carbon layer is one of the main constituents of the 2<sup>nd</sup> cut lining [2, 5 - 8].

Worldwide, SPL is produced in hundreds of thousands of tons annually as a waste from the production process of metallic Al. 1<sup>st</sup> cut SPL is considered as a hazardous material because it may contain, besides graphite, many other contaminants; e.g. fluorides, cyanides, lead and chromium in addition to its production of flammable gases when it comes in contact with water e.g. ammonia, phosphine, hydrogen and methane [4, 9, 10].

### 2.1.3 SPL Ingredients

Tables 1 and 2 summarize the ingredients of the 1<sup>st</sup> cut and 2<sup>nd</sup> cut spent pot lining that were reported by ALCOA, Inc. It's worthy to mention that the SPL ingredients can vary significantly from one to producer to another one that is because some producer used different additive in their process.

Table 1: 1<sup>st</sup> cut SPL ingredient/ History [15,16]

Components	Percent%
Carbon	40 – 60
Cryolite	15 – 24
Aluminum oxide (non-fibrous)	15 – 15
Sodium aluminate	5 – 10
Silica, amorphous	2 – 10
Aluminum fluoride	2 – 5
Sodium hydroxide	2 – 5
Silica, crystalline quartz	0 – 5
Iron oxide	0 – 5
Aluminum	1 – 3
Cyanide	0.2
Sodium beryllium fluoride	0 - 0.03

Table 2: 2<sup>nd</sup> Cut SPL ingredient/History[15]

<b>Component</b>	<b>Percent</b>
Silica, amorphous	50 – 70
Aluminum oxide (non- fibrous)	10 – 30
Silica, crystalline cristobalite	5 – 20
Cryolite	< 5
Iron oxide	< 5
Aluminum fluoride	< 2
Sodium aluminate	< 2
Sodium hydroxide	< 1
Cyanides	0.1

#### **2.1.4 SPL Hazards**

In some countries, USA for example, Environmental Protection Agency (EPA) considers only the first cut SPL as a hazardous material. Most of the companies and Hydro/Qatalum also deal with the first cut as more hazardous than the second one, because it releases high percentages of toxic gases when it contacts water or moisture [15, 16].

##### **2.1.4.1 1<sup>st</sup> Cut SPL Storage and Safety Precautions**

There are certain safety rules in order to deal with SPL properly and safely. Starting from the way of its handling and storage process, the most important precaution is to keep the waste away from any contact with skin and eyes, and avoid any generation of dust by using it under proper ventilation condition. Also, it is always a good idea to stay away from practices which decrease the alkalinity of the material and keep it far from acid. Eating, drinking and smoking should be prohibited in areas where this material is handled, stored, and processed. Furthermore, for women, it is good to avoid its contact during pregnancy or while nursing. Wear suitable respirator when the ventilation is insufficient. Also, one shouldn't enter storage areas and confined spaces that have 1<sup>st</sup> cut SPL unless sufficiently ventilated [15, 16].

##### **Personal safety tools: [15, 16]**

- Eye and face protection: wear protection glasses with side shields to protect your eye and face.

- Skin protection: wear good quality gloves and clothing to keep away from skin contact.
- Respiratory protection: wear full face mask to avoid any trace of gases or any dust inhaling

First aid protection: [15, 16]

- Eye contact: directly wash with plenty of water for at least 20 minutes.
- Skin contact: directly wash with soap and water for at least 15 minutes, if any symptoms occur get medical attention immediately.
- Inhalation: try to go to places with fresh air. Check for clear airway, breathing, and presence of a pulse.
- Ingestion: wash out mouth with water several times.

1<sup>st</sup> Cut SPL Storage:

1<sup>st</sup> cut spent pot lining should be stored and used away from heat, spark, open flame or any other ignition sources and kept away from moisture. Storage of the waste should be in agreement with local regulations. It should be kept away from strong acids and not to be put directly on the ground. In addition, it should be protected from any water precipitate i.e. in covered containers, sacks or tanks [15, 16].

## **2.2 1<sup>st</sup> Cut SPL Treatment Methods**

For long time, the 1<sup>st</sup> cut SPL was landfilled [17] to get rid of it. Furthermore, it was used to be throwing it in the desert far away from towns. Then, many researchers started to study this process to figure out its suitability for the environment. Consequently, they have discovered that 1<sup>st</sup> cut SPL is not degradable as was believed

earlier. After that, the researcher started working on that waste to find eco-methods to deal with it. A number of methods and processes have been suggested [18, 19]. The most general methods that approached the treatment of 1<sup>st</sup> cut SPL are: 1) hydrometallurgical treatment, 2) thermal treatment, 3) low-temperature leaching, 4) gas treatment and 5) chemical treatment.

### **2.2.1 Thermal treatment**

A lot of technological efforts have been made to use 1<sup>st</sup> cut SPL in many applications such as fuel sources for Rockwool manufacturing and co-firing in cement kilns. Both processes sometimes are difficult to be implemented due to the effects of 1<sup>st</sup> cut SPL on the final product quality and the regulatory rules for co-firing a hazardous waste product [20].

Alcoa [20] has found a Top Submerged Lance process in which the SPL is smelted with a submerged lance in a furnace with a high temperature of 1150 - 1250°C. The used temperature was high enough to destroy all CN<sup>-</sup> and organic materials. To maintain operations at these temperatures, energy was provided by the combustion of the carbon in the 1<sup>st</sup> cut SPL. This technology produced toxic gases. In order for this process to be industrially and commercially feasible, this technology needs to be connected to an HF acid plant to produce AlF<sub>3</sub> that can be reused back in the primary process.



In the patents: U.S. Pat. No. 5,711,018, U.S. Pat. No. 5,164,174 and U.S. Pat. No. 4,735,784, treatment of 1<sup>st</sup> cut SPL in a rotary kiln was described which led to the production of high quality ready-to-combust 1<sup>st</sup> cut SPL.

Electrode arc furnace is another thermal treatment that used SiO<sub>2</sub> source as a glass forming flux material, and Fe<sub>2</sub>O<sub>3</sub>, as an oxidizing agent. Both were mixed with crushed 1<sup>st</sup> cut SPL and supplied the mixture to a closed electrothermic furnace. This method was described in U.S. Pat. No. 5,286,274. The process was considered efficient in trapping the fluorine as CaF<sub>2</sub> in the slag. Mixing the oxidizing agent and graphite electrodes increased the consumption of the electrodes. This method was only commercially viable if reduced Fe<sub>2</sub>O<sub>3</sub> was recovered as metallic iron [20].

Matjaz et. al. [21] described the removal of free and complex CN<sup>-</sup> from 1<sup>st</sup> cut SPL using a thermal hydrolysis method as shown in Equation 2;

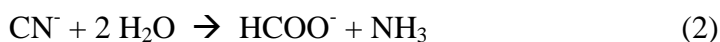

The experiment was done in the lab, and the used material was from Ernest Hage, Germany. A schematic diagram that summarizes the process is shown in Figure 2. The reactor is equipped with a vibratory stirrer working at 120 revolutions min<sup>-1</sup>. Heat was supplied by electric radiation heaters. The temperature was controlled within ± 5 K by means of an Fe-constant thermocouple which is installed in a steel tube inside the reactor and connected to a regulator. In addition, Ni-CuNi thermocouple was used to continuously measure the temperature. The pressure was measured in the reactor using a mechanical manometer. The reactants were injected in the 50 cm<sup>3</sup> chamber,

and the pressure was 200 kPa. A particular chamber also provided cooling of samples in order to store them for further analysis.

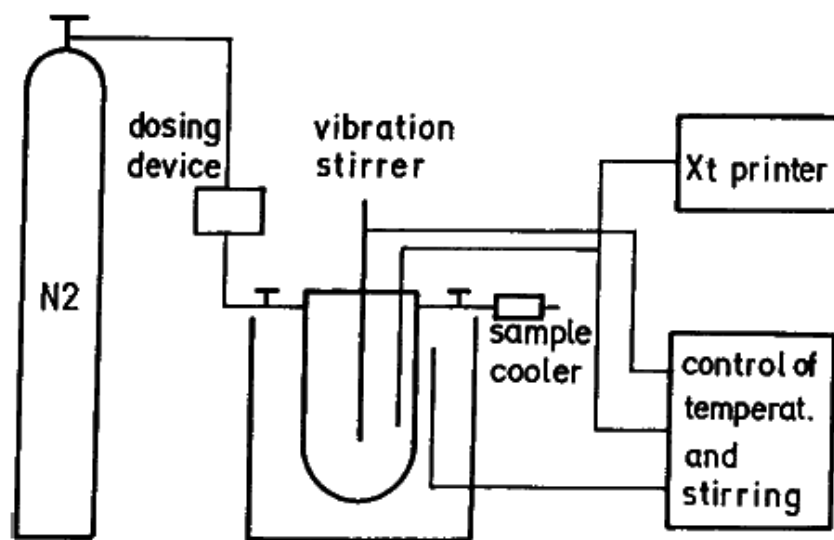

Figure 2: Laboratory apparatus for thermal hydrolysis of cyanides [21].

Luc Fortin et al.[22] worked on cyanide treatment by using thermal plasma in a novel reactor. The aim of their work was to determine the possibility of treating the free and complex cyanide in a solution over bench-scale operations. The reactor was designed to provide stable operating conditions. Different parameters were studied such as the NaOH concentration (32 and 57 g/L), initial 1<sup>st</sup> cut SPL leachate concentration (154 and 354 mg/L), plasma power (10 and 19 kW), and relative reactor pressure (0 and 1.34 MPa). The main outcome from these experiments was evaluating the kinetics of complex cyanide decay under thermal plasma conditions. Figure 3 shows the setup of their experiment which consists of a single direction current plasma torch fixed within a Pyrex reactor base having the top part open to the atmosphere. Four parts were set directly above the torch feed inlets for water production. A sight tube was used to preserve the solution level constant in the reactor. The cooling of the torch was set by a separated water circuit which was designed to work at power input levels of up to 25 kW. Internal diameter of 0.229 m in the upper section zone was located to separate the reaction gases from the process solution at the top of the reaction zone.

Post plasma characterization of the cyanide solutions was done by a wet analytical technique that was introduced by ALCAN International. The cyanide complexes were converted to gases (HCN) which were purified and absorbed in a NaOH solution. The micro-distillation system increased the amount of HCN from the total cyanide ion content.

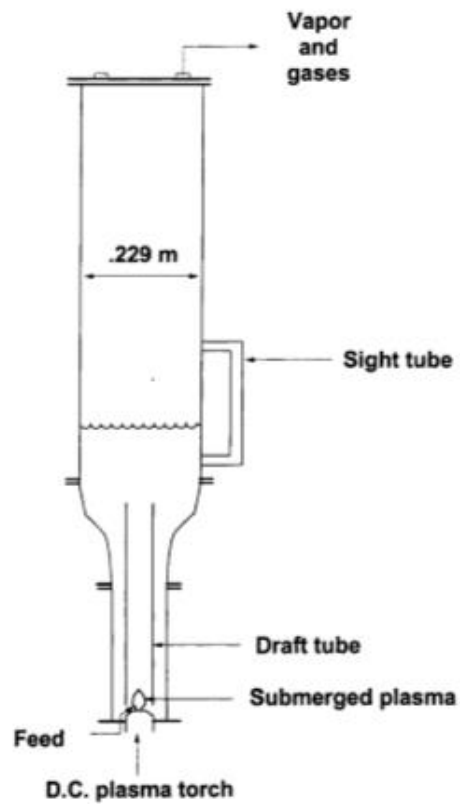

Figure 3: Luc Fortin et al. experimental setup [22].

### **2.2.1.1 Alcan Inertization Process**

Deutschman et. al. [23] developed another method to treat 1<sup>st</sup> cut SPL in a furnace at a low temperature of 350 °C for 60 min to get rid of CN<sup>-</sup>. The remaining untreated cyanide was chemically treated in a sigma blade mixer. At the end of the process, the mixture becomes dry due to the evaporation and the absorption of the hydration water by CaSO<sub>4</sub>. Based on this process, a plant was designed to produce a landfill disposable 1<sup>st</sup> cut SPL. In 1986, it was estimated that the cost of 1<sup>st</sup> cut SPL treatment was around \$100 per ton; hence, this process was proved to be less expensive and more acceptable for 1<sup>st</sup> cut SPL landfill disposal.

### **2.2.1.2 Alcoa Vitrification Process**

Another process founded by Nguyen and Hittner [24] of five-steps to treat and grind 1<sup>st</sup> cut SPL to less than 15 mm, followed by burning it at 800-850 °C. The burning initiated the mixing of ash with silicon materials. Thus, a glassy residue is formed suitable for landfill disposal.

### **2.2.1.3 Ogden Cyanide Removal Process**

Rickman [25] invented a process that can decrease the amount of cyanide in the 1<sup>st</sup> cut SPL to reach an environmentally nonhazardous level. In this process, the 1<sup>st</sup> cut SPL was ground to small sizes (less than 50 mm) of any dimension, and cooked in a steam of air or nitrogen at temperatures between 260-760 °C. The higher the roasting time (5 minutes or more) in a rotary kiln the more the decrease in the cyanide ions

content to desired stages without combustion of a major portion of the carbonaceous material. Subsequently, the end product was rich in carbon.

#### **2.2.1.4 *Imco Spent Pot lining Treatment Process***

Imco Recycling [26] established another method where the 1<sup>st</sup> cut SPL was treated with salt flux materials. Scrap aluminum sheet metal was placed in contact with the flux mixture in a molten form in relative amounts, so that the flux mixture comprises 50-70 wt.% of the total. In open flames, at temperatures between 704-816°C, aluminum from the 1<sup>st</sup> cut SPL was separated into a molten pure aluminum and all leachable species were removed essentially from the 1<sup>st</sup> cut SPL as nonvaporized materials in the flux mixture. After that, the lining components from the salt phase were recovered for disposal. The method is suitable for dumping 1<sup>st</sup> cut SPL without any risk.

#### **2.2.1.5 *Morrison-Knudsen Vitrification Process***

Davis and Kakaria [27], developed a process to clean 1<sup>st</sup> cut SPL from fluoride and cyanide ions by mixing it with silica and heating it up to 1000 - 1700°C in presence of steam to form slag. This method volatilizes the fluoride ions as HF and sodium fluoride. Afterwards, the slag cools down to form an insoluble silicate glass residue containing the non-volatilized contaminants in an immobile state. The resulted black glassy slag released fluoride and small amounts of cyanide (less than 0.01 mg/l) in water after 24 hr. The fluoride ions removal was 57.6% and the remaining cyanide in the residue was only 5 ppm.

#### **2.2.1.6 *Ogden Circulating Bed Combustion Process***

Ogden Environmental [28] Services created another procedure to treat 1<sup>st</sup> cut SPL by ignition. The procedure incorporates crushing the 1<sup>st</sup> cut SPL to particles of size around 5 cm. The combustor is commonly a circling bed combustor. Rickman [25] reported that the long haul objectives of Ogden Environment Services were to create, plan, build, and use 1<sup>st</sup> cut SPL combustors at a cost that is lower than that of landfills. A transportable treatment unit for the 1<sup>st</sup> cut SPL with a capacity of 10 kt/Y was developed, according to Rickman [29].

#### **2.2.1.7 *Qubator Pty. Ltd. Ceramic Material Process***

In this process, 1<sup>st</sup> cut SPL was crushed to approximately 2 mm and heated to 600-800°C in a muffle furnace or a rotary furnace at a rate of 200°C h<sup>-1</sup>. This process was developed by Branson and Vance [30]. The waste from aluminum smelters at this temperature was decomposed and the carbon was changed to carbon - free ash due to the oxidation of the graphite content. Then the ash was mixed and crushed with dead-burnt calcium sulfate in addition to aluminum oxide where the ash composes only 1/3 of this mixture. Then the mixture was heated at 1050°C for a sufficient period of time for the chemical combination of the reactive compounds, producing a heat treated ceramic material. The ceramic material is then crushed, milled, divided and mixed in fixed proportions with further additives, formed into shapes; and sintered to a final ceramic product, which is leached from sodium i.e. it became an eco-material.

### **2.2.1.8 Remetal Combustion Process**

Alfaro [31] developed a process to recycle 1<sup>st</sup> cut SPL by grinding and sieving it to 0.4 - 1.5 mm to get rid of aluminum and iron, the later magnetically. The rest of the materials was mixed with lime at low temperatures, to recover fluorine. At 500 - 600°C, 10% of lime was added directly for the calcination of the material.

### **2.2.2 Chemical Treatment: Ion Exchange Process**

Gudeep Singh et al. [32] worked on treatment and removal of fluoride from 1<sup>st</sup> cut SPL by using ion exchangers. In this work, they used the natural 1<sup>st</sup> cut SPL from Bharat Aluminum Company, Korba's (Madhya Pradesh, India) dump area. The concentration of the fluoride ions in the 1<sup>st</sup> cut SPL leachate was 175.22 mgL<sup>-1</sup> (Table 3), [33]. After treatment, the fluoride ions concentration decreased to 9.6 mg L<sup>-1</sup>. When an ion exchange column was used at a flow rate of 3 mL min<sup>-1</sup> and 200 mL of total 1<sup>st</sup> cut SPL volume that was leached at pH 9.37, complete removal of fluoride ions was achieved even in the presence of other materials in the 1<sup>st</sup> cut SPL leachate.



Table 3: Comparison between the efficiency of the different chemical techniques [32]

<b>Parameter</b>	<b>Concentration in the natural 1<sup>st</sup> cut SPL leachate</b>	<b>Concentration in the lime-treated 1<sup>st</sup> cut SPL leachate</b>	<b>Concentration in the ion exchange treated 1<sup>st</sup> cut SPL leachate</b>
pH	8.01	9.37	9.29
Conductivity, $\mu\text{S cm}^{-1}$	1.170	1.100	1.087
$\text{Al}^{3+}$ , $\text{mg L}^{-1}$	0.05	0.03	<0.01
$\text{F}^{-}$ , $\text{mg L}^{-1}$	175.22	9.60	<0.1
$\text{CN}^{-}$ , $\text{mg L}^{-1}$	0.08	0.03	<0.01
$\text{NH}_3$ (free), $\text{mg L}^{-1}$	<0.05	<0.05	<0.05
Iron, $\text{mg L}^{-1}$	0.83	0.21	0.08
Calcium, $\text{mg L}^{-1}$	0.06	2.24	0.08
Sodium, $\text{mg L}^{-1}$	250	260	243

They concluded that, this process is highly efficient and can be easily used to remove any other toxic substances efficiently such as cyanides, at pH range from 7 to 10.

### **2.2.3 Gas treatment: VAW Aluminum AG Silica Chlorine Treatment Process**

Wilkening [34] has worked on the treatment of solid fluorides that are found in the 1<sup>st</sup> cut SPL. He has established a process that treated this solid with silica in presence of chlorine gas at a temperature range of 400-900°C. Fluoride ions showed a 98% of conversion to gaseous silicon tetrafluoride, which is reacted with hydroxide or oxide (e.g., in aqueous suspension) to produce aluminum fluoride (AlF<sub>3</sub>).

### **2.2.4 Hydrometallurgical treatment**

Hydrometallurgy is a method for obtaining metals from their ores. It is a technique within the field of extractive metallurgy that uses aqueous chemistry for the recovery of metals from their raw materials, concentrates, and recycled materials [11]. Low caustic leaching and liming processes are two examples of hydrometallurgical methods that were developed by Alcan [9]. These methods involve three steps that require the use of complicated reactors. The first one is grinding 1<sup>st</sup> cut SPL and mixing it with caustic solution to remove the toxic at around 85°C. In the second step, a large quantity of sodium hydroxide is added at high pressure and temperature. This is necessary to destroy all cyanide in the leaching solution and produce sodium fluoride.

In the last step, more caustic material (generally lime) is added to the fluoride liquor to produce calcium fluoride and a recyclable, caustic leach solution. This process requires significant capital expenditure for the processing equipment and is

only commercially feasible on large scales (80,000 tons/year). In addition, it is claimed to generate more waste by mass as a by-product than it treats [9].

#### **2.2.4.1 ALCOA caustic leaching processes**

Bush [1, 4] developed this two-steps process including the recovery of halogens from 1<sup>st</sup> cut SPL. Initially, the 1<sup>st</sup> cut SPL was finely ground in to small pieces (<100 µm). This fine cut material was then leached with a low concentration of sodium hydroxide (14 g L<sup>-1</sup>) to produce fluoride-rich basic liquor with carbon material. After this, the sample was filtered, washed (with a mixture of acid bath containing aluminum sulfate and sulfuric acid at a temperature of 105°C), dried and ground. With acid leaching, carbon was separated from insulation materials. The summary for this leaching process is shown in Figure 4.

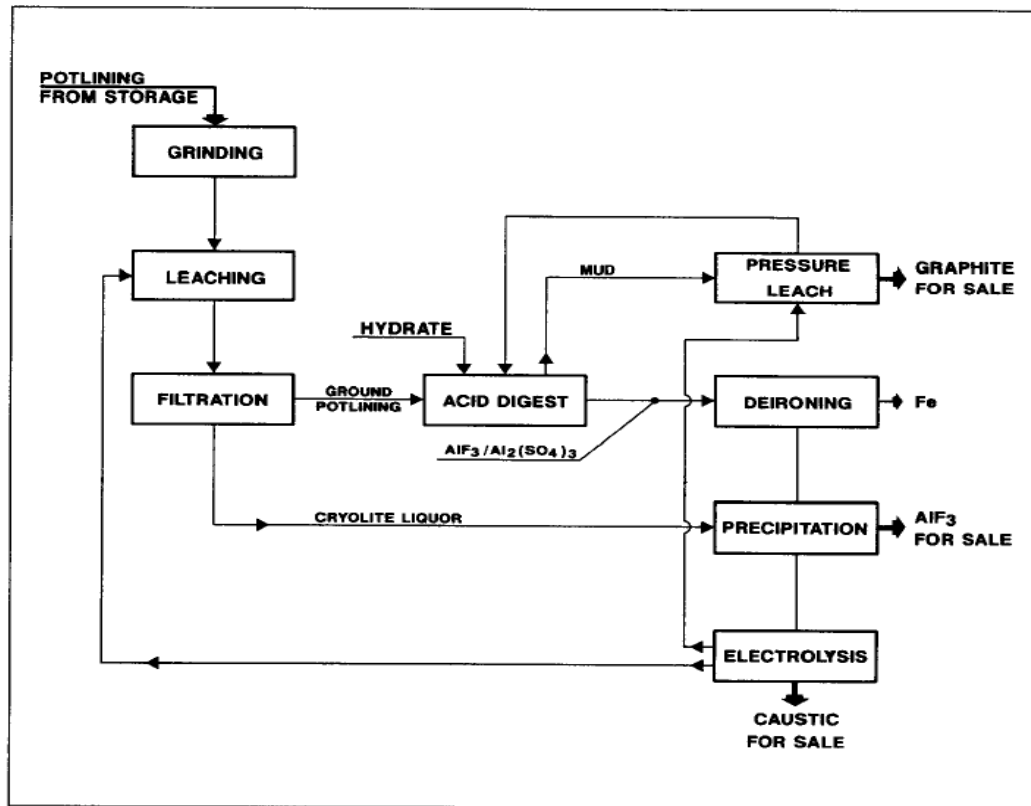

Figure 4: Alcoa caustic leaching process flow sheet [4]

#### **2.2.4.2 ALCOA flow - through leaching process**

This process consists of three interconnected operations, described by Blayen et al. [12]. 1<sup>st</sup> cut SPL was finely divided (10 mm) before putting it into a leaching container at 150 g min<sup>-1</sup>. 13 to 15 minutes was the average residence time that was recommended. This flow through leaching went on for two hours. To precipitate fluoride ions, the leachate was treated with high calcium lime. Hypochlorite treatment was designed to oxidize all cyanides. The total amount of the added calcium to leach fluoride ions was 16 wt%. This quantity is adequate to form calcium fluoride which lowers the fluoride and other anions concentrations in the leachate to suitable levels for recycle.

The produced precipitates were developed with the help of an anionic flocculent polymer. The remaining water at the end of the flow-through leaching cycle was removed from the leaching container, while the effluent precipitates were returned back to the flow through vessel. These remaining effluent precipitates were mixed with the remaining 1<sup>st</sup> cut SPL and hypochlorite. At the end of this step, the contents were pressed for final dewatering. By this, the solid product would be suitable for disposal in a conventional industrial landfill. It is worth mentioning that the remaining solid weight was 1.8 times more than the original 1<sup>st</sup> cut SPL and it contains 23 wt% water.

In 1987, the cost of the treatment of 25 kt of 1<sup>st</sup> cut SPL was \$8 million per year. This huge cost includes the disposal facility and the water treatment; however, the 1<sup>st</sup>

cut SPL crushing equipment is not included in this cost. By adding it, the operating cost (excluding the capital cost) is estimated to be around \$50 per ton.

#### **2.2.4.3 *Bharat Aluminium Company Leaching Process***

Nambiar et al. [35] worked on recovery of cryolite and anthracite coal (currently graphitized coal is used) that are produced from 1<sup>st</sup> cut SPL. They developed a process to deal with these types of materials by grinding and leaching the 1<sup>st</sup> cut SPL. There are some conditions that significantly affect the process e.g particles size, temperature and the leaching time with different solutions such as sodium hydroxide, acidic soda and water. At around 120°C, they found that the recovery of cryolite was in the range of 50-60% in the leachate with 3% sodium hydroxide. The solid to liquid ratio was around 1:5, and the whole process time was ½ hour. They have shown that processing of spent cathodes (1<sup>st</sup> cut SPL) from the aluminum electrolysis industry is cost efficient and prevented environmental pollution.

#### **2.2.4.4 *Comalco Mineral acid leaching process***

Jenkins [14] invented a process that is based on leaching the 1<sup>st</sup> cut SPL using a solution which contains mineral acid along with relating aluminum salt. The purpose from this step is to dissolve the aluminum and fluoride salts in the 1<sup>st</sup> cut SPL. This process involves two steps: first, the acid and the 1<sup>st</sup> cut SPL were mixed together and the mixture was aged, to avoid any dissolution of the silica, followed by adding the aluminum salt. Then, the precipitated fluorides from the leachate were thermally hydrolyzed. It is important to note that lime should be added to the 1<sup>st</sup> cut SPL at the

beginning in order to produce an ash material that has an environmentally acceptable level of cyanide ions, which will be leached later.

#### **2.2.4.5 *Companhia Vale do Rio Doce Leaching Process***

Vale do Rio Doce company [36] prepared its own process in which the 1<sup>st</sup> cut SPL was mixed with water for three to five days, followed by the addition of aqueous sodium hydroxide in amounts of 5-10 wt% at a temperature between 110-150 °C. The applied pressure was in the range of 1-6 bars. This process solubilized and recovered aluminum and fluoride as cryolite. After the aforementioned steps, the solution was filtered to remove all carbon-rich waste. Since the solution contained a huge amount of carbon dioxide, the formation of cryolite precipitate took place. This precipitate was removed by filtration. The solution pH was adjusted between 1.5- 2.0 by adding sulfuric acid, and the hydrogen cyanide (HCN) was removed from the solution mixture by heating it to about 50°C. The released HCN was bubbled into an aqueous calcium hydroxide solution. This step was done to form 10-30 wt% calcium cyanide solution. At the end, the solution which contains small concentrations (3 wt%) of fluoride and sodium cyanide ions was neutralized using lime.

#### **2.2.4.6 *Kryolitselskabet Sulfuric Acid Process***

From fluorine - containing waste materials, Mollgard [16] developed a method that can recover aluminum and fluoride ions as aluminum fluoride hydroxyl hydrate (AlF<sub>2</sub>OH). This process takes place in different steps. Initially, using sulfuric acid solution of pH 0-3, the 1<sup>st</sup> cut SPL was leached. Later, at the end of the leaching

process the pH was adjusted between 3.7 - 4.1 using a caustic aqueous solution. This will lead to precipitating silica and nonsoluble residues of the fluorine-containing 1<sup>st</sup> cut SPL. After this, purification of the solution will be done and  $\text{AlF}_2\text{OH}$  hydrate will be precipitated from the disinfected purified solution at a temperature within the range of 90-100 °C at a pH value not exceeding about 4.1. During all these steps, reducing or nonoxidizing operating conditions are maintained. Then within the range between 500 - 600°C the precipitate of  $\text{AlF}_2\text{OH}$  will be calcined to produce  $\text{AlF}_3$  and  $\text{Al}_2\text{O}_3$  which is suitable for using them in the electrolytic reduction of alumina.

#### ***2.2.4.7 Kryolitselskabet Soda Leaching Process***

This process was developed by Kryolitselskabet [18] to recover cryolite from 1<sup>st</sup> cut SPL at 80°C from soda solution. Sodium fluoride was added to the extract to control the ratio of F/Al ratio and contact with the 1<sup>st</sup> cut SPL (remaining cryolite in the 1<sup>st</sup> cut SPL is around 15-40%) from ore flotation to saturate the solution with cryolite, separate certain impurities; filtration; precipitation by carbon dioxide; separation; drying; classification or granulation of the precipitated cryolite.

#### ***2.2.4.8 Pechiney Lime Suspension Process***

Bontron et al. [18] had discovered another way for treating the 1<sup>st</sup> cut SPL. They founded a process that treated 1<sup>st</sup> cut SPL with aqueous solution of  $\text{CaCO}_3$  where SPL powder was suspended and fluoride ions were precipitated in forms of calcium fluoride, releasing sodium carbonate. After that, the suspension was heated in presence of argil to 140 °C or more. This step usually occurs after sodium carbonate



is fixed. This step is followed by separating the solid phase from the solution and then discharging it. The final step was recycling the solution and reusing it in another new suspension, crumbled 1<sup>st</sup> cut SPL.

#### **2.2.4.9 Detoxifying Waste Process**

Joseph B Cashman's [33] method was based upon detoxifying 1<sup>st</sup> cut SPL by getting rid of the different hazardous materials in it e.g. cyanides, fluoride and polynuclear aromatics. The first step is crushing the 1<sup>st</sup> cut SPL and reacting it with  $\text{CaCl}_2$  and hydrochloric acid at elevated temperatures and pressures. After that, the process included oxidation of the polynuclear aromatics using  $\text{FeCl}_3$  in oxygen at high temperatures and pressures (the temperature and the pressure are between 90-120°C and around 70 psi). Detoxifying the 1<sup>st</sup> cut SPL allows the landfill disposal of the solid waste residue.

The result of this study showed that the solid waste was mainly carbon and silicon. Changing the  $\text{CaO}$  by adding  $\text{CaCO}_3$  in the process makes  $\text{CO}_2$  evolves from the reactor. This process is considered relatively quick, simple, robust, and most importantly satisfies all environmental rules.

Table 4: Hydrometallurgical treatment results by Joseph [33]

<b>Element</b>	<b>Concentration before treatment (ppm)</b>	<b>Concentration after treatment (ppm)</b>	<b>Standard Toxicity Characteristic Leaching Procedure (TCLP) (mg/l)</b>
Fluoride, free	5	2	48
Cyanides, amenable ppm	11.1	<0.5	30
Cyanides as total CN	25	<0.5	590
Acenaphthylene	<1.65	<3.4	-
Acenaphthene	<1.65	<4.95	3.4
Anthracene	2.020	<3.4	3.4
Benzo(A)Anthracene	24.7	<3.4	3.4
Benzo(A)Pyrene	28.5	<1.35	3.4
Benzo(B)Fluoranthene	55.2	<4.95	6.8
Benzo(G,H,I)Perylene	24.6	<1.8	1.8
Benzo(K)Fluoranthene	55.2	<4.95	6.8
Chrysene	27.2	<3.4	3.4
Dibenzo(A,H)Anthracene	8.49	<1.35	8.2
Fluoranthene	42.4	<3.4	3.4
Fluorine	<1.65	<4.95	-
Indeno(1,2,3-C,D)Pyrene	18.9	<3.4	3.4
Naphthalene	<1.65	<4.95	-
Phenanthrene	17.1	<4.95	3.6
Pyrene	31.0	<4.95	8.2

This research developed a new idea by adding iron powder to destroy polynuclear aromatic with a concentration of 5-10 wt%. The results are shown in the Table 4.

#### **2.2.4.10 Leaching under ultrasound**

In this process [37] 50 g of carbon powder was leached using 500 mL of water in presence of ultrasound at room temperature (20°C). Kinetics of the release of  $F^-$ ,  $Na^+$ , and  $CN^-$  in the leachate was reported as shown in Figure 5. The measured pH after leaching was found to be 12.2. The reason of this is attributed to the  $NH_3$  that is produced from hydrolysis of  $AlN$ . After 20 min of sonication almost all ions are released in the leachate. In the absence of sonication the plateau in the curve in Figure 5 and 6 takes weeks until it developed. This clearly illustrates that the efficiency of the washing process was increased dramatically in presence of sonication.

The more water was used for leaching, the higher the concentration of the ions in the leachate. This behavior was checked for three ions shown in Figure 6. Furthermore repeating the leaching process resulted in more release of the ions to the leachate solution although not with the same extent as the 1<sup>st</sup> leaching cycle. This effect of was shown in Figure 7 where the second leaching cycle released less ions and the third cycle released even more less ions.

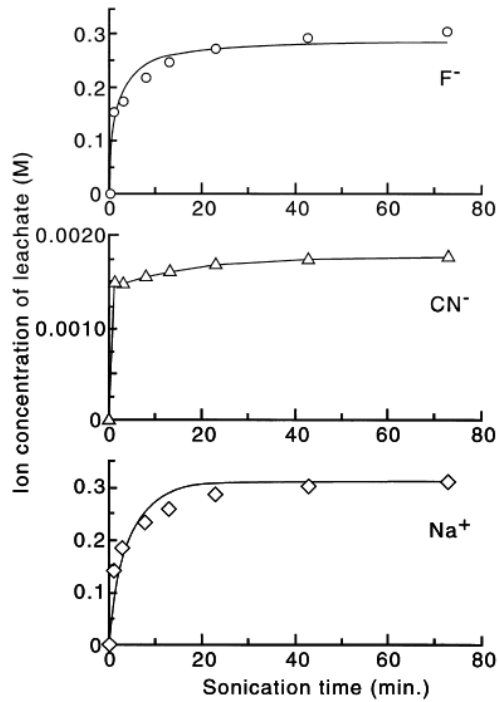

Figure 5: Ion concentration profiles vs. sono-leaching time for carbon powder in pure water [37]

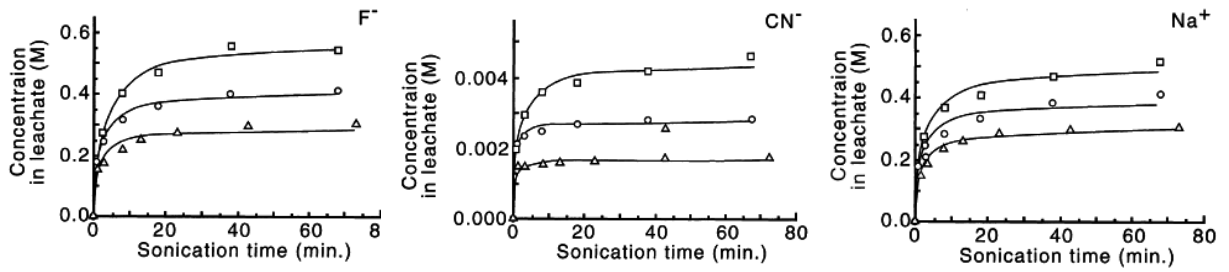

Figure 6: Ions leached from carbon under ultrasound in  $\square$ 200,  $\circ$ 300 and  $\Delta$ 400 ml of water [37]

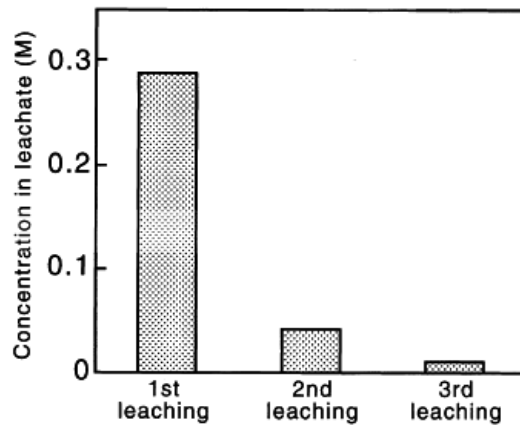

Figure 7: F<sup>-</sup> concentration in leachate after sono-leaching with 50g carbon powder in 500ml water [37]

Diego Fernandez Lisbona et al. [40] explained two stages process that deals with the treatment of 1<sup>st</sup> cut SPL. The leachate comprises of water, Al<sup>3+</sup> and F<sup>-</sup> was recovered as an aluminum hydroxyl fluoride product. Their work included modeling of aluminum fluoride equilibrium to explore the effect of pH. Furthermore in their work, they have focused on manipulating the precipitation morphology to reduce crystal growth with an ultimate objective of recovering a product and converting it to smelter grade AlF<sub>3</sub>.

The chemical that has been used in this work was analytical reagent grade. 1<sup>st</sup> cut SPL was taken from Anglesey Aluminium Ltd. (UK) with size of 10–30 cm long x 5–10 cm wide chunks [42]. Before they started dealing with it, 1<sup>st</sup> cut SPL was washed for 24 hours with water. Spent pot lining was broken down to small particles by a jaw crusher. After that, 1 - 2 mm particles were collected for leaching test. Alkali fusion method was used here to determine content of fluoride [41].

The raw 1<sup>st</sup> cut SPL was measured in XRD at 800°C for five hours (Figure 8). Intensity peaks show higher corresponding to NaF and CaF<sub>2</sub>, while NaAl<sub>11</sub>O<sub>17</sub> and aluminium silicates show a lower intensity. Figure 9 shows that the intensity was reduced for NaF and CaF peaks relative to Al<sub>2</sub>O<sub>3</sub> and NaAl<sub>11</sub>O<sub>17</sub> after washing them with water and the leached Al<sup>3+</sup> ions were removed by aching at 80°C [40 , 32].

Table 6 summarizes all the treatment methods for 1<sup>st</sup> Cut SPL. As can be seen from this table the most of the methods are focusing on treating cyanide and fluoride ions because of their toxicity. The next import target in all treatment methods are heavy metals.

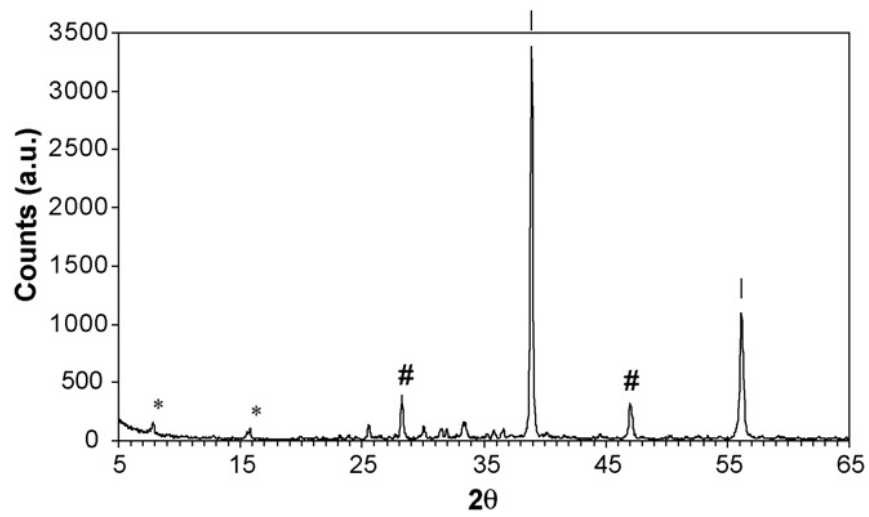

Figure 8: XRD pattern of inorganic fraction from raw SPL recovered by ashing at 800°C for 5 h. Marked peaks correspond to  $\text{NaAl}_{11}\text{O}_{17}$  (\*),  $\text{CaF}_2$  (#) and  $\text{NaF}$  (|).[40]

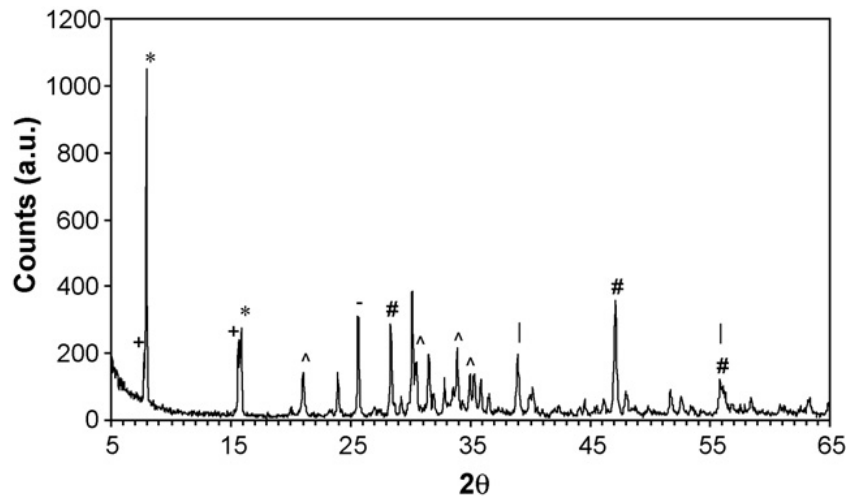

Figure 9: XRD pattern of inorganic fraction from SPL residue after water wash and  $\text{Al}^{3+}$  leach recovered by ashing at 800 °C for 5 h. Marked peaks correspond to  $\text{NaAl}_{11}\text{O}_{17}$  (\*),  $\text{CaF}_2$  (#),  $\text{NaF}$  (|),  $\text{Na}_{1.95}\text{Al}_{1.95}\text{Si}_{0.05}\text{O}_4$  (^),  $\text{Al}_2\text{O}_3$  (+) and  $\text{LiAlSi}_3\text{O}_8$  (-).[40]

Table 5: Summary types of treatment methods for 1<sup>st</sup> cut SPL

Process numbers	Type of methods	Names of methods	Targeted ions/materials	Conc. Of treatment		Cost	Needs landfill	End product	Reference	Advantage	Disadvantage	
				before	after							
A	Thermal	Alcoa	CN <sup>-</sup>	-	-	-	Yes		20	Remove all ions	Produce toxic gases	
		Matjaz el. at.	CN <sup>-</sup>	-	-	-	Yes		21			
		Luc Fortin et. al	CN <sup>-</sup>	154mgL <sup>-1</sup>	-	-	-	Yes	Clean	22	Evaluating the kinetics of cyanide decay.	-
		Alcan Inertization Process	CN <sup>-</sup>	-	-	\$100	Yes	Clean	23	-Less expensive -Acceptable for solid disposal for environment	-	
		Alcoa Vitrification Process	F <sup>-</sup> , CN <sup>-</sup>	-	-	-	Yes	Clean	24	Removed all the ions		
		Ogden Cyanide Removal Process	CN <sup>-</sup>	-	-	-	Yeas	Clean	25	Destroy all cyanide ions		
		Imco Spent Pot lining Treatment Process	F <sup>-</sup> , CN <sup>-</sup>	-	-	-	Yeas	Clean	26	Useful process to dump SPL		

		Morrison-Knudsen Vitrification Process	F <sup>-</sup> , CN <sup>-</sup>	0.01mgL <sup>-1</sup>	75%	-	No	Not clean	27	Easy process	It is not removing all the ions
		Ogden Circulating Bed Combustion Process	CN <sup>-</sup> , F <sup>-</sup>	-	-	High	Yes	Clean	28,25	Remove all the ions by ignition	High energy
		Qubator Pty. Ltd. Ceramic Material Process	F <sup>-</sup> , CN <sup>-</sup>	-	-	-	Yes	Clean	30	Less temperature is required	Long process to treat SPL
		Remetal Combustion Process	Al, Fe, F <sup>-</sup>	-	-	-	Yes	Clean	31	Easy process to get rid of all ions	Higher temperature required
<b>B</b>	<b>Chemical</b>	Ion exchange methode	F <sup>-</sup> , CN <sup>-</sup>	179.22mg L <sup>-1</sup>	9.6m g L <sup>-1</sup>	-	No	clean	32,33	F removed even present of other materials	-
		ALCOA Caustic leaching processes	Halogens	14gL <sup>-1</sup>	-	Good	-	-	4	-	-
		ALCOA flow-through leaching process	F <sup>-</sup> , CN <sup>-</sup>	150g. min <sup>-1</sup>	-	High \$8millions	Yes	-	12	-	Very expensive
		Bharat Aluminium Company Leaching Process	Cryolite/an thracite coal	-	-	Good	No	Clean	35	Cost efficient and prevent pollutions	-
<b>C</b>	<b>Hydrometallurgical</b>	Comalco Mineral acid leaching process	F <sup>-</sup>	-	-	-	-	Clean	14	Acceptable level of cyanide ions	Ash produce



		Companhia Vale do Rio Doce Leaching Process	Al, F <sup>-</sup>	-	-	-	No	Clean	36	Lime neutralized F and Na ions	Formation of Cryolite precipitate
		Kryolitselskabet Sulfuric Acid Process	F <sup>-</sup> , Al	-	-	-	No	Clean	16	Controlled additions of caustic solution	-
		Kryolitselskabet Soda Leaching Process	Cryolite	-	-	-	No	Clean	17	Separate impurities	-
		Pechiney Lime Suspension Process	F <sup>-</sup>	-	-	-	No	Clean	18	Recycling of solution	-
		Detoxifying Waste Process	CN <sup>-</sup> , F <sup>-</sup>	-	-	-	Yes	Clean	33	Quick Simple Satisfy environmental rules	Solid waste residue
		Leaching under ultrasound	F <sup>-</sup> , CN <sup>-</sup> , Na	-	-	-	No	-	37	Efficient	Repeat is required
		Diego Fern´andez Lisbona et al	Al, F <sup>-</sup>	-	-	-	No	Clean	40-42	Recovery of product	-

### 3. Major applications of 1<sup>st</sup> cut SPL

The heating value required for spent pot lining is 25.2 MJ kg<sup>-1</sup> [46] and it is almost equal to bituminous coal. The total 1<sup>st</sup> cut SPL produced worldwide was approximately 800,000 tons by year 2003. This means that 1<sup>st</sup> cut SPL can be employed as alternative fuel [46].

In 2010, the U.S recycled up to 79% of SPL in cement kilns [44]. While in Australia, in 2009, 7449 tons of 1<sup>st</sup> cut SPL were recycled mostly in cement industry as an alternative fuel [43, 45].

These applications have negative environmental impacts. The cyanide content of 1<sup>st</sup> cut SPL was shown 0.033% at 20°C [46]. It is worthy to mention that some studies claims that almost 99.9% of cyanide ions were destroyed when 1<sup>st</sup> cut SPL was used as a fuel in cement kilns [47]. Lechtenberg [48] reported that the using 1<sup>st</sup> cut SPL reduces the release of NO<sub>x</sub> and CO<sub>2</sub>. Lechtenberg also indicated that utilizing 1<sup>st</sup> cut SPL would provide extra amounts of raw materials such as silica, alumina and ferrous components which are not favorable in the cement industry. 1<sup>st</sup> cut SPL has high amounts of fluorides, so the treatment and transportation of 1<sup>st</sup> cut SPL could be a serious environmental issue if not done properly.

Also, the extracted graphite could be employed in various applications. This graphite can be used in the making composites or other applications in which graphite, graphene oxide, or reduced graphene oxide can be used.

### 3. Materials & Equipment's

#### 3.1 Materials

##### 3.1.1 1<sup>st</sup> Cut SPL

The 1<sup>st</sup> cut SPL samples that were used in this study were donated by Qatar Aluminum Company (Qatalum) in Mesaieed, Qatar. In 2009, Qatalum started its aluminum production. The 1<sup>st</sup> cut SPL was collected after five years of operation. Figure 10 show the way that was used to collect the 1<sup>st</sup> cut SPL. The cell to be delined was divided into four quarters assuming that they have the same composition. After that, 6 samples were collected from one courter, grinded, mixed and used in the experiments.

The collected samples (chunks) were 2 kg each. They were crushed in order to obtain a 1<sup>st</sup> Cut SPL powder. This powder was further processed, using the Cryomill instrument (Figure 11), to obtain 1<sup>st</sup> cut SPL powder (Figure 12).

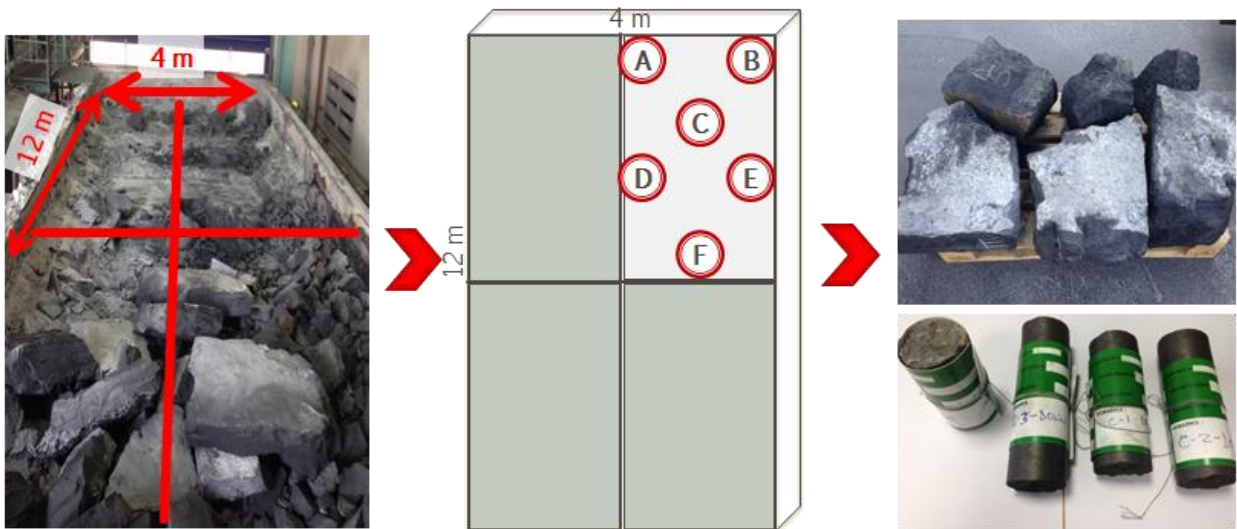

Figure 10: steps of collecting 1<sup>st</sup> cut SPL samples

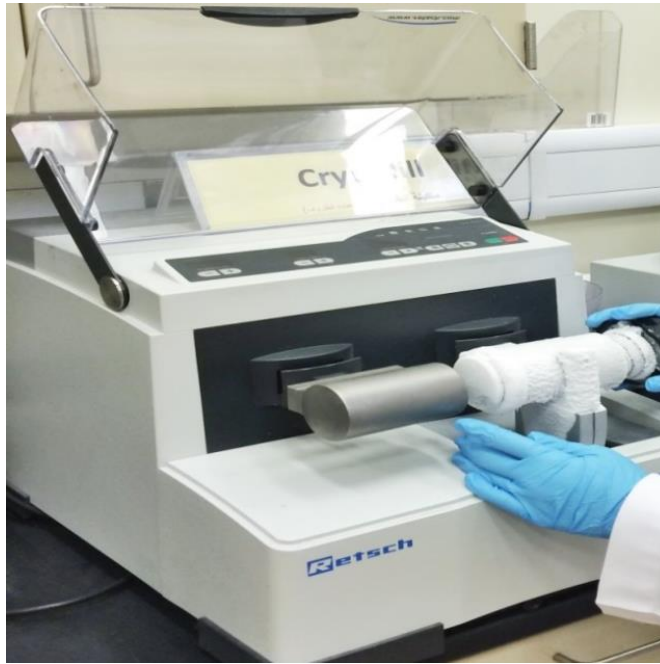

Figure 11: Cryomill machine used for 1<sup>st</sup> cut SPL grinding.



Figure 12: Fine powder of 1<sup>st</sup> cut SPL.

### 3.2 Chemicals and Accessories

1 liter Tedlar<sup>®</sup> Gas Sampling Bags (Figure 13) were used to collect gases during the washing procedure. Gas bags were purchased from Supelco analytical, Bellefonte, PA, USA. Diluted sodium hydroxide (NaOH), and nitric acid (HNO<sub>3</sub>) were used. Both were purchased from Sigma Aldrich and used without any further purification. Moreover, sulphuric acid (H<sub>2</sub>SO<sub>4</sub>), potassium permanganate (KMnO<sub>4</sub>), sodium nitrate (NaNO<sub>3</sub>), copper sulphate (CuSO<sub>4</sub>), hydrogen peroxide (H<sub>2</sub>O<sub>2</sub>) and deionized water were used for the extraction of graphite and graphene preparation, functionalization and application.

### 3.3 Graphite Extraction

In this work, the treatment of 1<sup>st</sup> cut SPL was started by washing it with deionized water. As per literature review, once it contacts water, different gases were expected to be emitted and these should be collected using gas bags (Figure 13). Gas chromatography – mass spectrometry instrument (GC-MS) was used to analyze the collected gasses when the 1<sup>st</sup> cut SPL reacted with water. Then, this 1<sup>st</sup> cut SPL was washed several times with organic solvents to dissolve the existing organics. After that, the surface characterization was done using Fourier transform infrared spectroscopy (FTIR) to check the presence of surface functional groups on the graphite surface. The powder was further treated with cycles of different concentrations of NaOH, HNO<sub>3</sub> (4 M, 2 M) and deionized water (Figure 13) to remove the remaining inorganic contaminants. The effluents, resulted from the

chemical treatment and washing processes, were collected and analyzed using ionic chromatography (IC) and inductively coupled plasma (ICP). The purity of the produced graphite powder was characterized using FTIR and X-ray diffraction (XRD).

Graphene was prepared from the extracted graphite powder using modified Hummers' method [64]. Initially, 2 g of graphite powder (200 mesh, 99.99%), 1 g of sodium nitrate, was added to 50 ml of concentrated  $\text{H}_2\text{SO}_4$  and stirred vigorously at  $0^\circ\text{C}$  for 3 hr. After that, 6 g of potassium permanganate was slowly added to the solution and further stirred at Real-Time Transport Protocol (RTP) for another 3 hrs. The solution soon turned pasty and dark green in color with the evolution of gas bubbles. Subsequently, 100 ml of distilled water was slowly added to this solution and stirred for 30 min. until a brown color is visible. Furthermore, 100 ml of Hydrogen peroxide ( $\text{H}_2\text{O}_2$ ) was added which turns the mixture into bright yellow. This suspension is then filtered and washed with an excess amount of warm deionized water and kept to dry overnight under vacuum at  $60^\circ\text{C}$ . The dried materials is the graphene oxide (GO). Afterwards, 0.1 g of the dried GO was sonicated in 20 ml of deionized water until a homogeneous yellow dispersion was obtained. The GO was dispersed easily in water due to the presence of a variety of hydrophilic oxygen groups (i.e.  $^-\text{OH}$ ,  $\text{O}^{-2}$ ,  $\text{COO}^-$ ) on both the basal planes and edges.

The solution suspension was placed inside a conventional microwave after adding 40  $\mu\text{l}$  of the reducing agent [hydrazine hydrate (HH)]. The microwave oven was then operated at full power (1000 W), 2.45 GHz, in 30 s cycles (on for 10 s, off and

stirring for 20 s) for a total reaction time of 60 s. The yellow dispersion of GO gradually changed to a black color indicating the chemical reduction to “graphene” or “reduced graphene oxide.



Figure 13: Collected gases after washing 1<sup>st</sup> Cut SPL with water.

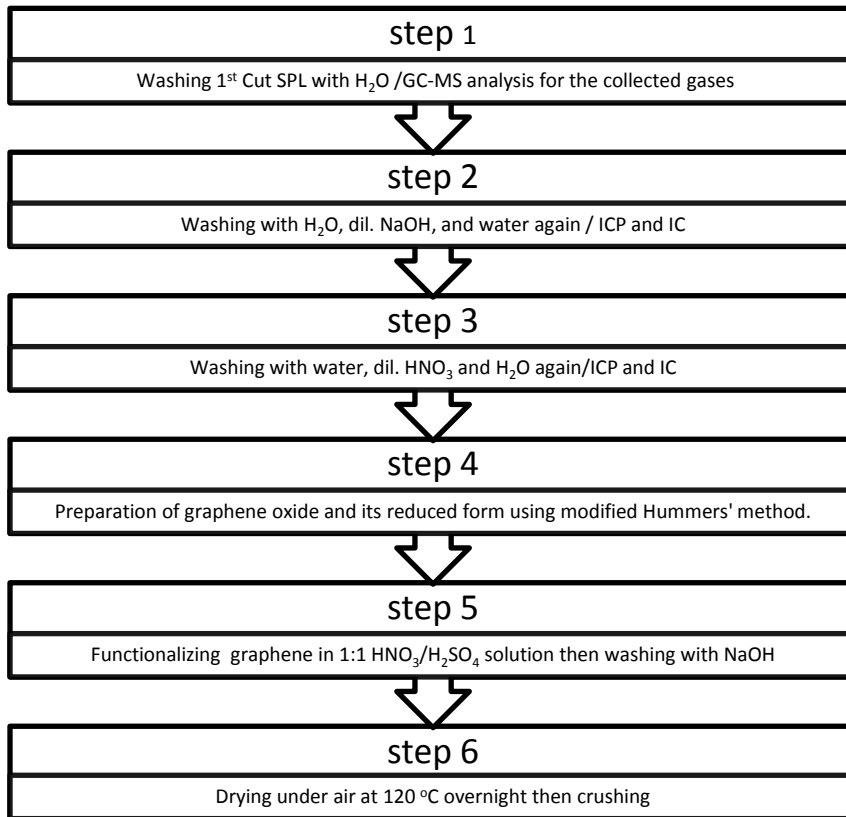

Figure 14: Summary for the research design and method.

Figure 14 is summarizing the chemical treatment of the 1<sup>st</sup> cut SPL to extract the graphitic component and preparation of graphene oxide and its reduced form “graphene”.

The produced graphene powder was functionalized through boiling in 1:1 of H<sub>2</sub>SO<sub>4</sub>:HNO<sub>3</sub>, then washed with deionized water and hot NaOH to convert the carboxylic groups on the surface into ionizable carboxylate groups. This helps in increasing the negative charge on the graphene’s surface once mixed with water which is expected to increase its efficiency of adsorbing more cations.

## **3.4 Equipment**

### **3.4.1 CryoMill**

The CryoMill (Retsch) was particularly designed for cryogenic grinding (Figure 12). The grinding jar is repeatedly cooled with liquid nitrogen from the integrated cooling system before and during the grinding process. Thus the sample is embrittled and volatile components are conserved. The liquid nitrogen circulates through the system and is continually replenished from an auto fill system in the exact amount which is required to keep the temperature at –196 °C. The automatic cooling system guarantees that the grinding process does not start before the sample is thoroughly cooled. These results are in reduced feeding of the grinding and guarantees reproducible grinding results.



### 3.4.2 Gas Chromatography/Mass Spectrometry (GC/MS)

For gas chromatography/mass spectrometry, Agilent 6890 / 5973 GC/MS system was used in this work (Figure 15). Volatile products are carried by a purge gas, and absorbed at the head of the chromatographic column by the column material, and subsequently desorbed by fresh purge gas. This adsorption-desorption process occurs repeatedly as the volatile products are entering the column [49]. Each component passed through the column has its own characteristic rate. The composition of the purge gas was then determined as a function of time at the column outlet. The emergence time of a GC peak is unique to each component and the peak area is proportional to the concentration of that component.



Figure 15: GC-MS system while testing the evolved gas from 1<sup>st</sup> cut SPL samples after washing with deionized water

### 3.4.3 Fourier Transform Infrared Spectroscopy (FTIR)

Light incident on any system may suffer transmission, reflection, scattering, and absorption. The FTIR spectrum 400, PerkinElmer system was used in this work (Figure 16). Spectroscopy is called the fingerprint of a molecule, as the IR spectrum registers many specific information concerning the molecule.[49, 50] The characteristic band parameters in FTIR are frequency (energy), intensity (polar character), band shape (environment of bonds), and the polarization of the various modes, that is, transition-moment-directions in the molecular framework. Thus FTIR is a powerful tool to identify the functional groups on the surface of 1<sup>st</sup> cut SPL samples [49].



Figure 16: FTIR instrument that was used to qualitatively analyze the 1<sup>st</sup> cut SPL samples.

### 3.4.4 Thermogravimetric Analysis (TGA)

Thermogravimetric analysis (TGA) Pynris6 TGA, PerkinElmer system was used in this work (Figure 17). TGA is a thermal method that involves the measurement of weight loss as a function of temperature or time [51, 52]. In TGA a 1<sup>st</sup> cut SPL sample was placed in a furnace while being suspended from one arm of a sensitive balance. The change in the samples mass was recorded as the sample is subjected to a heating sequence. A heater ramps temperatures up to 800°C at a rate of 0.1 – 300°C min<sup>-1</sup>. Both modes (heating and cooling) of samples are possible [53]. The measured TGA curves (Thermograms) for different samples throughout this work was plotted as a relation between mass loss and heating temperatures.



Figure 17: TGA instrument that was used to measure thermograms for different 1<sup>st</sup> cut SPL samples

### 3.4.5 X-ray Diffraction (XRD)

Rigaku, Miniflex II X-ray diffractometer was used in this work (Figure 18). Diffraction occurs when a wave encounters a series of regularly spaced obstacles that are capable of scattering the wave and have spacing that is comparable in magnitude to the wavelength of the radiation. X-rays have high energies and wavelengths which are of the order of the atomic spacing's for solids. When a beam of X-rays interact with a solid, a portion of the beam is scattered in all directions by the electrons associated with each atom existing within the path of the beam and another portion is diffracted. [53] The intensities of the diffracted beams were detected by a counter which was mounted on a movable carriage. Its angular position was measured in terms of  $2\theta$ . As the counter moves at a constant angular velocity, a recorder plots the diffracted beam intensity as a function of the diffraction angle ( $2\theta$ ).



Figure 18: X-ray diffractometer that was used in this work.

### **3.4.6 Scanning Electron Microscopy (SEM) & Energy Dispersive X-ray Spectroscopy (EDX)**

Morphology of the 1<sup>st</sup> cut SPL samples' surfaces were documented using scanning electron microscopy (SEM, NOVANANOSEM, and FELTM (Figure 19). In this technique fine electron beams (5-10 nm) were scanned along the sample surface in synchronization with a beam from a cathode-ray tube. The produced scattered electrons results in a signal which modulated this beam. Hence, an image was created with a depth-of-field, which is approximately 300-600 times better than that of an optical microscope in addition to obtaining a three-dimensional image [53]. To identify the elemental composition, Energy Dispersive X-ray Spectroscopy (EDX) was used which measures the generated X-ray that is produced because of the interaction of the electrons beams with the material's surface. EDX is not a surface analysis technique since its information is averaged from a layer of 20  $\mu\text{m}$  thick.

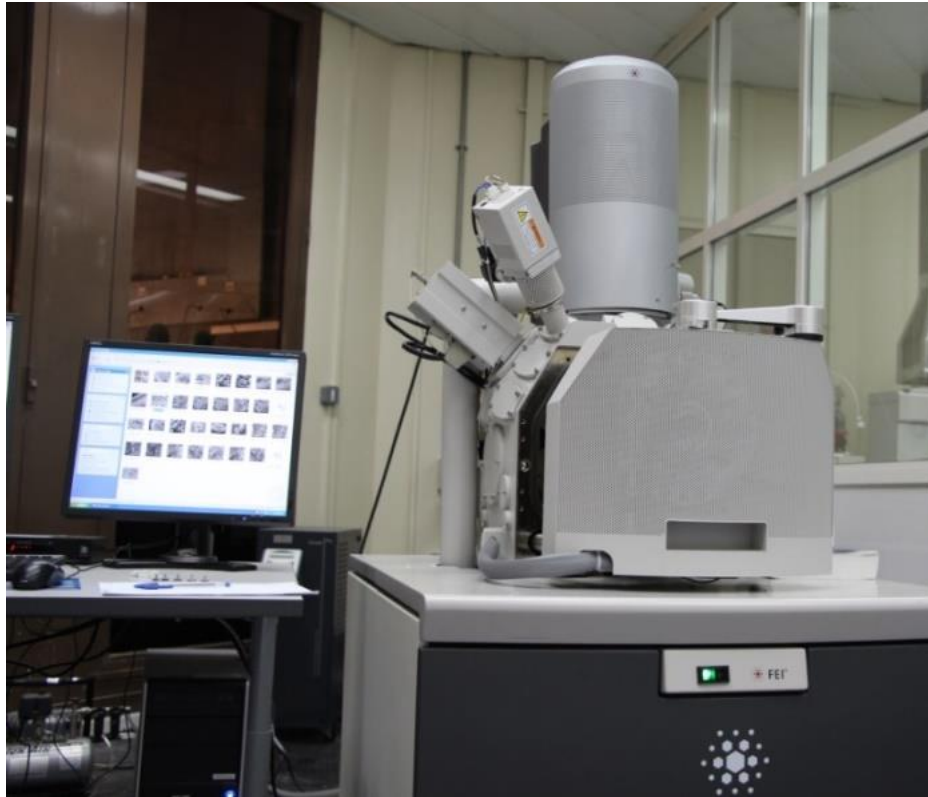

Figure 19: SEM&EDX instrument that was used in this work.

### 3.4.7 Ion Chromatography (IC)

Ion chromatography (model:858, metrohm),[\[54\]](#) (Figure 20) was used to quantify polar substances throughout a wide concentration range. Many ions can be studied in a single determination experiment. Complete atomization of ion chromatography is easy and helps to save time and reduce costs. Due to its reliability and robustness, ion chromatography was used in this work to identify different ions after washing the 1<sup>st</sup> cut sample with water, acid and alkali.

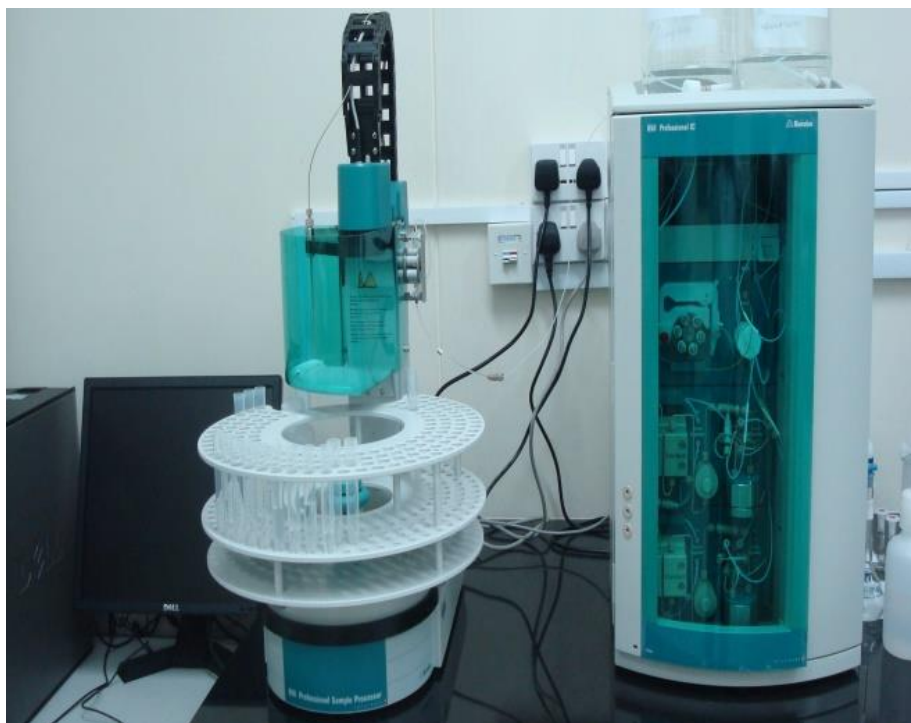

Figure 20: Ions Chromatography instrument used in this work.

### 3.4.8 Inductively Coupled Plasma (ICP)

In this technique (Figure 21), the necessary ionization was achieved using plasma. The plasma was directed axially on to the apex of a cone with a small orifice at its peak. The cooler outside sheath of the plasma was diverted away radially by the cone, and the core plasma was then passed into the mass spectroscopy analyzer. The ICP (Nexion 300D, PerkinElmer) system was mainly used to identify and quantify elements of 1<sup>st</sup> cut SPL samples [54].

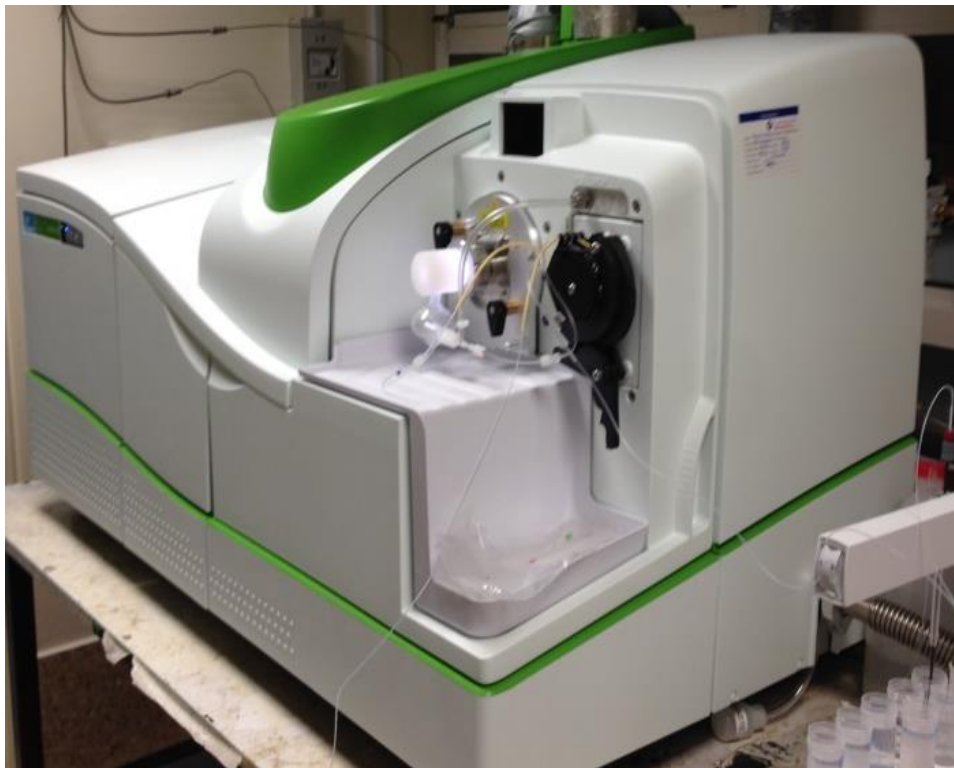

Figure 21: Inductively Coupled Plasma instrument used in this work.



## 4. Results & Discussion: 1<sup>st</sup> cut SPL

### 4.1 Gas Chromatography/Mass Spectrometry (GC/MS)

GC-MS measurements were conducted for the evolved gases that were collected in a gas bag after washing the 1<sup>st</sup> cut SPL with water. Table 6 shows the mole percentage of the different gases that were collected from the 1<sup>st</sup> cut SPL sample after it was washed with the water. N<sub>2</sub> has the highest percentage comparing to the other gases [55]. Surprisingly, the mole percentage of the hazardous gases that were collected from 1<sup>st</sup> cut SPL was very low. This means that Qatalum's 1<sup>st</sup> cut SPL is cleaner than what was reported in literature from other Al producers [15, 16]. Equations 2 – 6 summarize the possible reactions that may generate some gases when 1<sup>st</sup> cut SPL contacts water [55].

Table 6: Collected gases after washing 1<sup>st</sup> cut SPL with water.

Gases		Hydrogen	Oxygen	Nitrogen	Methane	Ammonia	phosphine
1 <sup>st</sup> cut SPL	Percentage (Mole %)	0.1	21.3	76.0	0	2.5	-

Hydrogen gas was found due to aluminum reaction with water as shown in equations 2 and 3 [55].

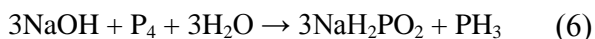
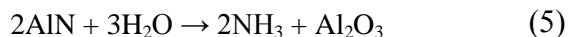
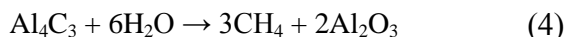

## 4.2 Fourier Transform Infrared Spectroscopy (FTIR)

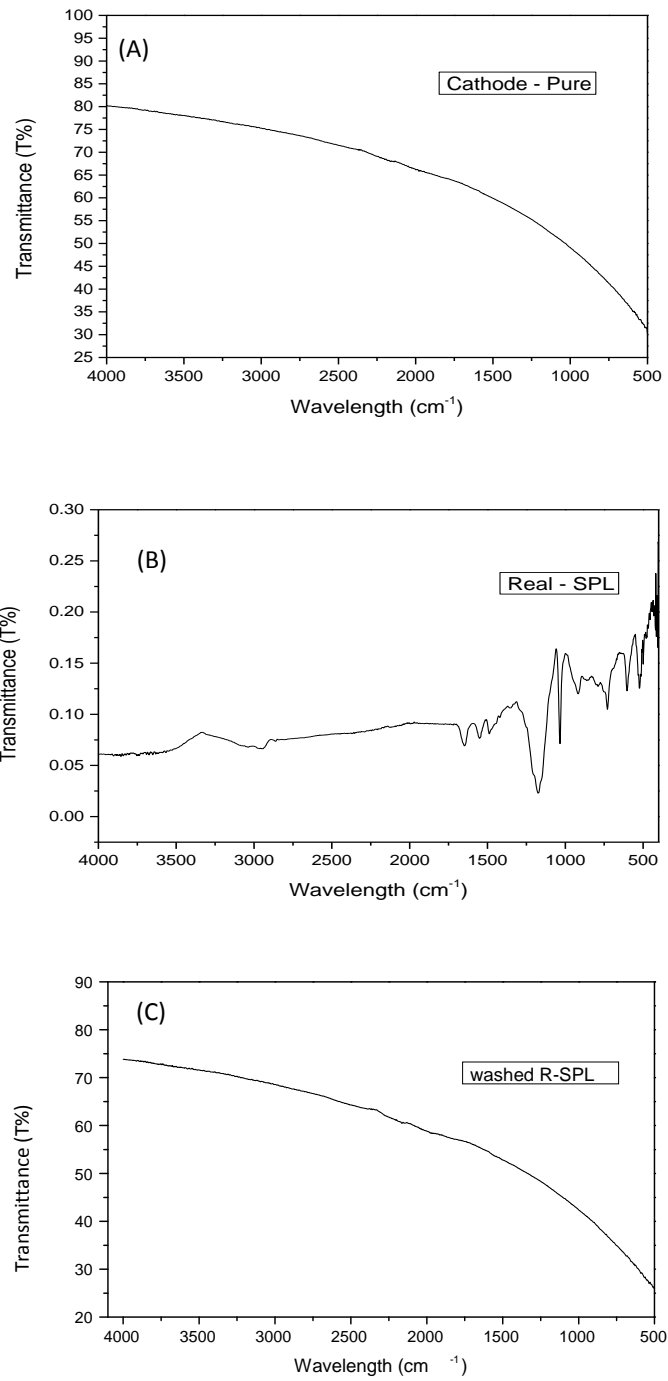

Figure 22: FTIR Charts for A) Pure cathode; B) un-washed and C) washed 1<sup>st</sup> cut SPL

Figure 22 compares the FTIR spectra for (A) pure cathode material, (B) unwashed 1<sup>st</sup> cut SPL and (C) 1<sup>st</sup> cut SPL after one full washing cycle. It is clear that after washing, the 1<sup>st</sup> cut SPL specimen (Figure 22C) is identical with the pure cathode material (Figure 22A). The 1<sup>st</sup> cut SPL FTIR spectrum (Figure 22B) didn't show N-H stretching bands. The aromatic C=C-H stretching band was very weak around 3000 cm<sup>-1</sup>. Instead, a strong band corresponding to C-O ether functional group was shown at a frequency of 1210 cm<sup>-1</sup>. Furthermore, stretching band for carbonyl group (-C=O) was weak but was existing at frequency of 1710 cm<sup>-1</sup>. It is worthy to mention that stretching the double bonds of nitro groups was shown at 1560 and 1385 cm<sup>-1</sup> respectively.

### 4.3 Thermogravimetric Analysis (TGA)

Thermal analysis was also carried out for the 1<sup>st</sup> cut SPL before and after washing and the results was compared with pure cathode pot lining material. Figure 23 compares the thermograms for (A) pure (unused) pot lining, (B) as-received and (C) washed 1<sup>st</sup> cut SPL. It shows that the new (unused) pot lining cathode material has almost similar thermal behavior to the washed 1<sup>st</sup> cut SPL at high temperatures. At low temperatures, the washed 1<sup>st</sup> cut SPL has different thermal behavior because of the water content. Also, the new cathode (pot lining) material (unused) adsorbed N<sub>2</sub> gas at the low temperature regime which led to a little increase in the mass. In general the 1<sup>st</sup> cut SPL has more thermal stability [57, 58]. Not only that, but also the amount of the organic compounds are much lower compared to the one reported in literature.

This might be attributed to the complete use of graphitized carbon in the cathode carbon blocks compared to the non-graphitized carbon material that was previously used.

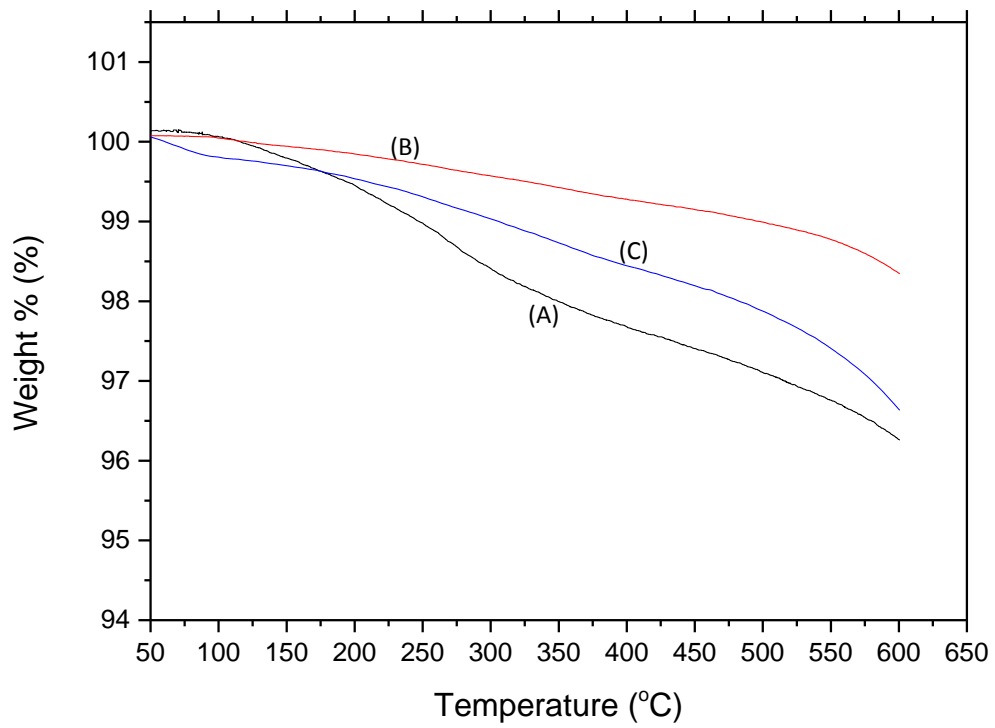

Figure 23: Thermograms for (A) pure cathode and 1<sup>st</sup> cut SPL (B) before and (c) after washing.

#### 4.4 X-ray Diffraction (XRD)

Figure 24 reveals the XRD patterns for the (A) unused “Pure” cathode material, (B) as-received and (C) washed 1<sup>st</sup> cut SPL. Comparing figure 24 B and C, it can be clearly seen that the washing cycles are efficient in removing all aluminum and sodium fluoride (NaF) particles from the 1<sup>st</sup> cut SPL. Furthermore, by comparing Figures 24A and C, it can be concluded that the washing cycle was able to clean the 1<sup>st</sup> cut SPL where its XRD pattern is identical to the new “unused” cathode material where the Al metal peaks at  $2\theta = 37.5$  and  $58.8^\circ$  have disappeared [40]. The particles size of the Al metal within the as-received SPL was calculated from the Scherrer’s modified equation (Equation 7) [66] to be 14 nm and for graphite (at  $2\theta = 26.4^\circ$ ) 12.4 nm.

*Scherrer's Equation:*

$$particle\ size = \frac{K\lambda}{\beta \times \cos\theta} \quad (7)$$

Where  $K$  is a dimensionless shape factor which has a typical value of 0.9 but it may vary with the actual shape of the crystallite,  $\lambda$  is the X-ray wavelength,  $\beta$  is the line broadening at half the maximum intensity in radians and  $\theta$  is the Bragg angle.

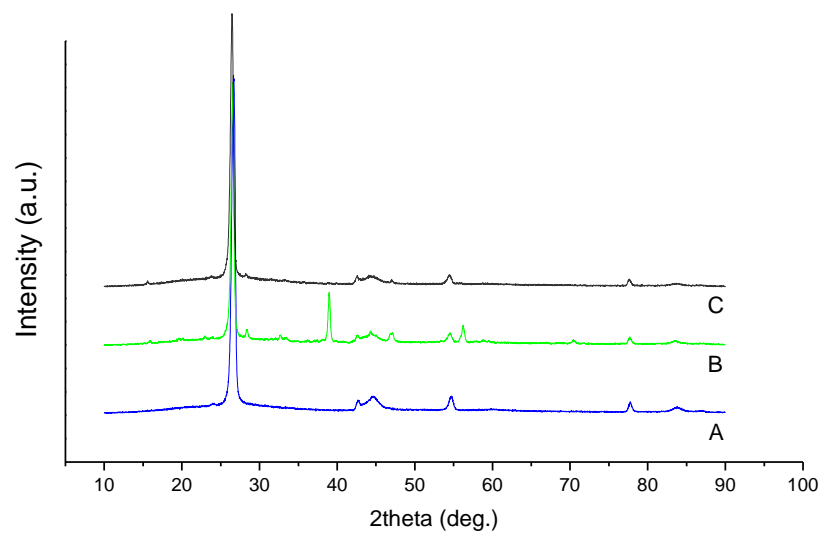

Figure 24: XRD diffraction patterns (A) unused cathode, (B) unwashed and (C) washed 1<sup>st</sup> cut SPL

## 4.5 Scanning Electron Microscopy (SEM)

The morphology of the (A) new “unused” cathode material, (B) as-received 1<sup>st</sup> cut SPL and (C) washed 1<sup>st</sup> cut SPL was revealed by the SEM micrographs shown in Figure 25. It is clear that there was no much difference between the three cases to be reported. The particle size was found to be around 5  $\mu\text{m}$ .

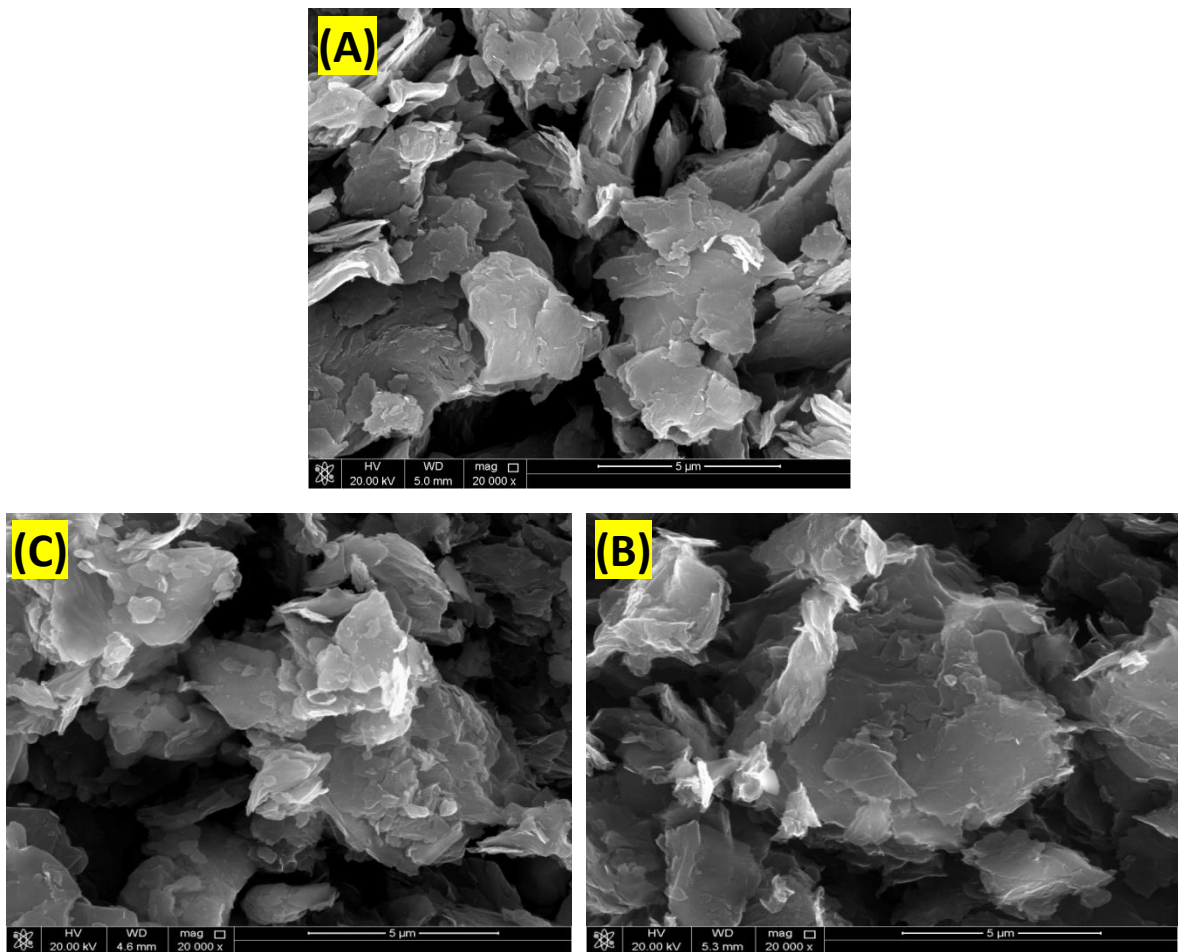

Figure 25: SEM images for (A) pure cathode, (B) washed and (C) unwashed 1<sup>st</sup> cut SPL

## 4.6 Energy Dispersive X-ray Spectroscopy (EDX)

The elemental analysis for the 1<sup>st</sup> cut SPL before and after washing is shown in Table 7. Comparing the carbon content of the 1<sup>st</sup> cut SPL (before and after washing), it can be clearly seen that carbon content in the washed 1<sup>st</sup> cut SPL has increased significantly. This confirms that the proposed washing cycle in this work was successful to clean the as-received 1<sup>st</sup> cut SPL. Also, an important notice to be mentioned here that confirms the previous conclusion, the percentage of aluminum and all other elements except oxygen has decreased in 1<sup>st</sup> cut SPL after washing. The reason that the oxygen content increased is the oxidation of the graphite surface to form aldehydic and carboxylic functional groups due to using nitric acid.

Table 7: Chemical analysis for 1st cut SPL before and after washing using EDX technique.

Elements		C	O	F	Na	Mg	Al	Si	K	Fe	Ti	Ca	Cl
1 <sup>st</sup> cut SPL	<b>Before Treatment</b> [wt%]	73.0	2.1	14.7	7.1	0.2	1.4	-	-	0.40	-	1.1	-
	<b>After Treatment</b> [wt%]	96.0	2.4	0.9	0.2	-	0.1	-	-	-	-	0.4	-



## 4.7 Ion Chromatography (IC)

Washing effluents of the 1<sup>st</sup> cut SPL after using each of H<sub>2</sub>O, NaOH and HNO<sub>3</sub> were collected and tested using IC technique to quantify the F<sup>-</sup> and Cl<sup>-</sup> ions. The results are summarized in Table 8.

Table 8: conc. Of F<sup>-</sup> and Cl<sup>-</sup> ions in the washing effluents after several washing cycles for 1<sup>st</sup> cut SPL using IC technique.

No. of washing cycles	Concentration (ppm)					
	H <sub>2</sub> O		NaOH		HNO <sub>3</sub>	
	F <sup>-</sup>	Cl <sup>-</sup>	F <sup>-</sup>	Cl <sup>-</sup>	F <sup>-</sup>	Cl <sup>-</sup>
1	46.60	40	80.5	35	3.2	5.2
2	26.8	20	45	20	2	3
3	10	5	0	0	0	0
4	0	0	0	0	0	0

The results of the 1<sup>st</sup> cut SPL it can be confirmed that only two washing cycles are needed to remove all the F<sup>-</sup> and Cl<sup>-</sup> ions from the powder. Also, NaOH was shown to be the best washer in terms of cleaning the 1<sup>st</sup> cut SPL where the ions concentration in the effluent after NaOH washing was the highest compared to the other washing chemicals (H<sub>2</sub>O and HNO<sub>3</sub>). Also, water was proven to be the worst to remove the ions from the 1<sup>st</sup> cut SPL powders.

## 4.8 Inductively Coupled Plasma (ICP)

Table 9 summarizes the  $\text{Al}^{+3}$  and  $\text{Na}^+$  ions concentration using the ICP analysis of the washing effluents of the 1<sup>st</sup> cut SPL. As the numbers of washing cycles increase, the concentration of the ions in the effluents decreases. It can be seen that only two washing cycles were enough to wash out all the  $\text{Al}^{+3}$  and  $\text{Na}^+$  in the 1<sup>st</sup> cut SPL. It can be easily find that 1<sup>st</sup> cut SPL is much cleaner when two washing cycle were carried on.

Table 9:  $\text{Al}^{+3}$  and  $\text{Na}^+$  conc. in the washing effluents of 1<sup>st</sup> Cut SPL

No. of washing cycles	Concentration (ppm)					
	$\text{Na}^+$ ( $\text{H}_2\text{O}$ )	$\text{Na}^+$ ( $\text{NaOH}$ )	$\text{Na}^+$ ( $\text{HNO}_3$ )	$\text{Al}^{3+}$ ( $\text{H}_2\text{O}$ )	$\text{Al}^{3+}$ ( $\text{NaOH}$ )	$\text{Al}^{3+}$ ( $\text{HNO}_3$ )
1	600	0	500	10	544	187.9
2	250	0	62	1.62	100	20.92
3	0	0	0	0	0	0
4	0	0	0	0	0	0
5	0	0	0	0	0	0

## **5. Application**

### **5.1 Graphene as an adsorbent for heavy metals ions removal**

Water contamination is a worldwide challenge. Many heavy metals ions are considered among the most toxic substances that can pollute water [59]. Exposure to heavy metals such as, copper, cadmium, mercury, and arsenic has been connected with many health problems and is responsible for development many diseases. Heavy metal ions can undergo a sequence of long-range transport mechanisms that improve their diffusion through the environmental phases. Water contamination sources are mostly derived from industrial activities, such as production and processing of metals, mineral industry, chemical industry, waste and water management, and energy-related sources associated with fuel combustion. Natural contamination is present as well, where contamination of groundwater can be derived from natural rocks leaching [60, 61].

Many worldwide research and legal works have been integrated in the last few years to face up this challenge, including the foundation of emission standards and environmental standards for natural and industrial waters e.g. Water Framework Directive [62]. The Instruction on Integrated Pollution Prevention and Regulator [63], aims to avoid or minimize pollution of water, air, and soil by industrial waste; to this end, it requires the application of best available technologies in industrial facilities to decrease the release of heavy metals to water [64].

The presently adopted technologies mainly include coagulation/co-precipitation, ion exchange, membrane technologies, and adsorption processes. But, bearing in mind the worldwide increase in the water contamination because of heavy metal ions, depuration methods should be categorized according to their efficiencies, simplicity, cost, and possibility to make use of the local available materials.

In this thesis the extracted graphite from the 1<sup>st</sup> cut SPL was chemically converted into reduced graphene oxide (graphene) with high surface to adsorb and remove heavy metals ions from water.

## **5.2 Materials and Methods**

After the extraction of graphite and the complete washing of it, graphene oxide (GO) was prepared using modified Hummers' method [65]. GO was converted to reduced graphene oxide "graphene" since it has higher surface area and can remove larger amounts of ions compared to graphite.

Graphene was functionalized through boiling in 1:1 of H<sub>2</sub>SO<sub>4</sub>:HNO<sub>3</sub> then washed using deionized water and hot NaOH to convert the carboxylic acid groups on the functionalized graphene into carboxylate ions i.e. increasing the negative charge on the graphene surface once mixed with water.

100 ppm solutions of CuSO<sub>4</sub> were prepared at different pH values of 1, 2, 3 and 7. After that, 0.1 g of the functionalized graphene was added to 100 mLs of each solution, then the solutions were shaken at a constant rate for 1 hour. Next, the mixture was filtered to separate the functionalized graphene from the solution, and

then the filtrates were taken to ICP for measuring the concentration of  $\text{Cu}^{+2}$  ions that are still remaining in the filtrate.

For comparison, exactly similar amounts of functionalized carbon black (Vulcan carbon) which was functionalized using the same technique that has been used for functionalizing graphene were used to adsorb  $\text{Cu}^{+2}$  ions from 100 mL of  $\text{CuSO}_4$  solution (100 ppm each) with different pH values of 1, 2, 3 and 7.

### 5.3 Results and Discussion

Figure 26 shows the XRD pattern of the (a) graphite, (b) GO and (c) graphene. This confirms the successful preparation of them from the graphite that was extracted from 1<sup>st</sup> cut SPL.

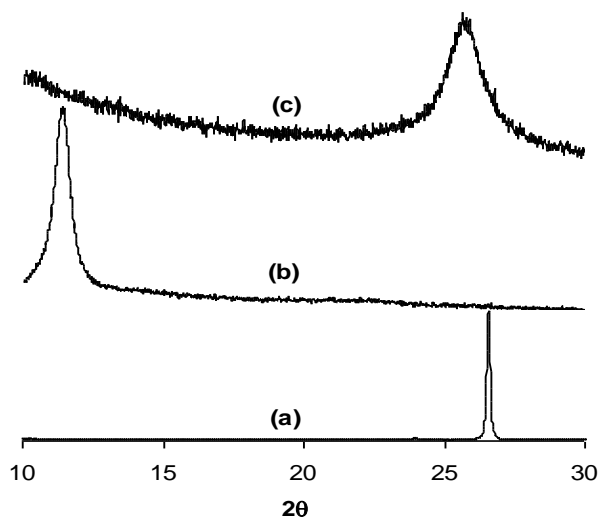

Figure 26: XRD patterns of (a) graphite, (b) graphene oxide and (c) graphene.

FTIR spectroscopy proved the functionalization of the graphene by showing the carbonyl groups at 1760 and hydroxyl group at 3410  $\text{cm}^{-1}$  as shown in Figure 27.

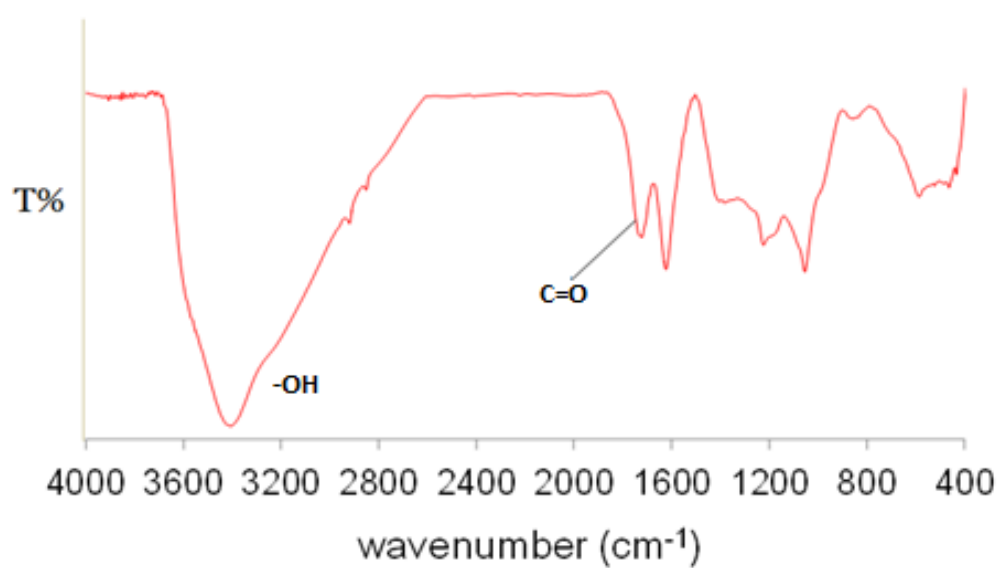

Figure 27: FTIR of the functionalized graphene.

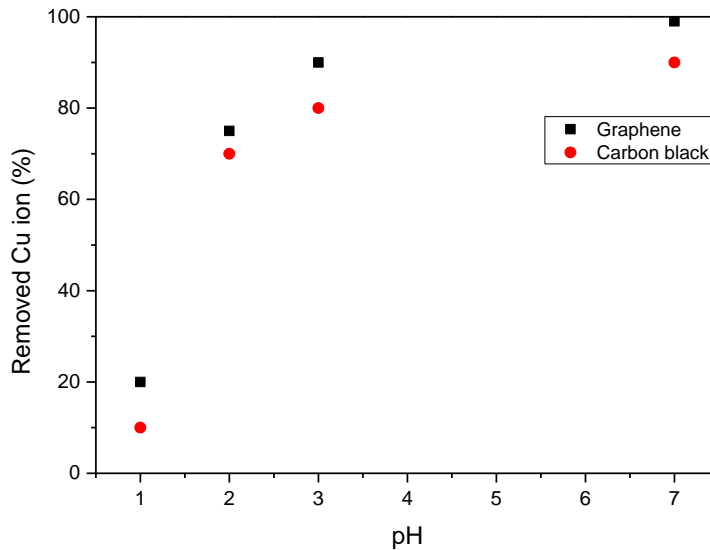

Figure 28: Removal of Cu ion (%) for pH 1, 2, 3 and 7

Figure 28 shows a comparison between the efficiency of the functionalized graphene and Vulcan carbon. Always graphene shows higher efficiency than Vulcan carbon at all pH values. At pH 7, the efficiency of functionalized graphene was almost 100 % compared to only 90 % for functionalized Vulcan carbon, due to the high surface area of the graphene compared to Vulcan carbon.

## 6. Summary and Conclusions

The 1<sup>st</sup> cut SPL was successfully washed and characterized using a washing and characterization schemes that involved a combination of organic and inorganic solvents e.g. ethanol, acetone, H<sub>2</sub>O, HNO<sub>3</sub> and NaOH to extract the carbonaceous component which was proven to be mainly graphite (> 96%) as shown using XRD, FTIR, elemental analysis and EDX. Also, the results were compared to the unused pot lining cathode material. In every step in the washing scheme, the effluents were collected and analyzed using IC and ICP. The detected ions are Al<sup>+3</sup>, Na<sup>+</sup>, F<sup>-</sup> and Cl<sup>-</sup>. It was proven that the 1<sup>st</sup> cut SPL was cleaned from (i) the concentration of the ions in the effluent after several washing cycles, (ii) the number of needed washing cycles to completely extract pure graphite and (iii) the types and amounts of gases that were evolved (detected and measured using GC-MS) when the 1<sup>st</sup> cut SPL was washed with water. The 1<sup>st</sup> cut SPL needs only two washing cycles for complete extraction of graphite. Also, hydrogen and ammonia gases were generated from the 1<sup>st</sup> cut SPL upon contact with water. In general, it can be easily mentioned that the 1<sup>st</sup> cut SPL of Qatalum is much cleaner and less hazardous when compared to other companies' 1<sup>st</sup> Cut SPL. Also, it is much cleaner than what is reported in literature in 1991 when less graphitic carbon was used at that time. This indicates that although increasing the graphitic component in the pot lining, have increased the cost, it led to a cleaner 1<sup>st</sup> cut SPL on the long run which is consequently less hazardous. It is worthy to mention



that TGA proved that the 1<sup>st</sup> cut SPL thermal behavior is very close to the new “unused” cathode material.

Graphene was prepared from the extracted graphite using Hummers’ modified method with a large surface area ( $\sim 357 \text{ m}^2 \text{ g}^{-1}$ ). The surface of graphene was successfully functionalized by adding –ve charges to its surface and was used to adsorb the positively charged  $\text{Cu}^{+2}$  ions from water at different pH values. It was found that at a pH value of 7 almost 100 % of  $\text{Cu}^{+2}$  was removed using the functionalized graphene.

## 7. Future work

The extension of this work can be directed in different fields. For example, continuing characterization for the organic materials that are washed off the 1<sup>st</sup> cut SPL is an important extension that will enrich understanding the nature and hazards of this 1<sup>st</sup> cut SPL which is a byproduct of the aluminum industry in Qatar at Qatalum. Also, the transient change of the pot lining surface with time is another important factor to be studied. Furthermore, slicing the 1<sup>st</sup> cut SPL to investigate the chemical composition as a function of depth is a wrathful study area that needs to be covered. In addition, sonication and shaking during the washing process was reported to enhance and expedite the washing process. This is why it is worth trying to use sonication beside the designed washing scheme for 1<sup>st</sup> cut SPL that was used in this study. Besides, the application of the extracted graphite can be boosted significantly through controlling the surface of the graphene (produced from graphite). The control is in terms of surface area, charge and types of attached functional groups. The used reduction method to obtain graphene from graphene oxide was a wet chemical one. It is worthy to mention that thermal and H<sub>2</sub> reduction of graphene oxide at different temperature has been reported to produce graphene with higher quality in terms of surface area and purity. Also, the effect of cation valency on the adsorption efficiency of the functionalized graphene needs more attention.

## References

1. Bush, J.F., "Reclaiming Spent Potlining,". 1985. U.S. patent.
2. Tschöpe, K., *Degradation of Cathode Lining in Hall-Héroult Cells*, . in Norwegian University of Science and Technology. 2010.
3. Kvande, K.G.a.H., "Introduction to Aluminium Electrolysis. Aluminium-Verlag Marketing and Kommunikation GmbH" . in Germany. 1993.
4. Bush, J.F., "Process to Produce AlF<sub>3</sub> Caustic, and Graphite from Spent Potlinings in an Environmentally Acceptable Manner,". Light Metals, 1986. p. pp. 1081-1099.
5. Harald Oeye, Morten Soerlie, "Cathodes in Aluminium Electrolysis. Aluminium-Verlag", ed. n. edition. Germany: Düsseldorf. 1994.
6. Jeppe, C.P., Matuszewicz, R W, " Development of Ausmelt Technology for Recovery of Contained Values from Spent Pot Liner". Light Metals Symposium, 1996.
7. Harpley, J., "SPL Fluoride Use as a Substitute For Commercial Aluminium Fluoride at the Portland Aluminium Smelter" (Portland Aluminium Confidential Internal Report ) .2001.
8. Somani, P.R., "Importance of Transmission Electron Microscopy for Carbon Nanomaterials Research", . 2007.
9. Chris Chapman, H.L., David Deegan, " Method for treating spent pot liner", . 2011.
10. Pawlek, R.P., "spent potlining-water-soluble components, landfill and alternative solution", Light Metal, 1993. :p. 399-473.
11. Habashi, F., "Recent Trends in Extractive Metallurg", Mining and Metallurgy, .2009. :p. 45,pp. 1- 13.
12. Blayden L.C, S.C.H., and S.J. Robuck, "Spent Potliner Leaching and Leachate Treatment", Light Metals, . 1987. :pp.663-667.
13. Soerlie, M. and Oye, H.A. "Study on Used Cathode Linings of Aluminium Pots", Bull. Electrochem, .1987.:pp. 45-49.
14. Jenkins D.H., "Recovery of Aluminium and Fluoride Values from Spent Potlining", (1 November 1991).
15. Robert Sedney, "Recovery of Components from Electrolytic Cell Wastes m Aluminum Manufacture",.1988.
16. Kaaber H., Mollgaard M., "Aluminium Fluoride Recovery from Fluorine-Containing Waste Materials from Aluminium Manufacture", .1991.
17. Cashman, Joseph.B., "Detoxifying aluminum spent pot liners for solid waste landfill", .1998. USA. :p. 18.
18. Aunsholt K.E., "Plant for Regeneration of Cryolite from Spent Potlining", Light Metals,.1988.: pp. 899-904.
19. Jean-Claude Bontron, Pierre-Bernard Personnet, Jean-Michel Lamerant, "Procede de Traitement par Voie Humide de Brasquage Uses Provenant de Cuves d'Electrolyse Hall-Heroult",.1990.

20. Matjaz Cencić, Ivan Kobal, and Janvit Golob, "*Thermal Hydrolysis of Cyanides in Spent Pot Lining of Aluminium Electrolysis*", chem. Eng. Technol. WILEY-VCH Verlag GmbH, D-69469 Weinheim, .1998.
21. Fortin, L., et al., "*Novel reactor for cyanide solution treatment*", Chem. Eng. ((Copyright (C) 2014 American Chemical Society (ACS). All Rights Reserved.) . 2000. :p. 643-649.
22. Deutschman, J.E, et al. "*A Process to Produce from Spent Potlining an Inert Residue Suitable for Landfill Sites*", Light Metals, .1987. : pp. 669-675.
23. Quyen C. Nguyen; Herman J. Hittner, "*Stabilization of fluorides of Spent Potlining by Chemical Dispersion*", .1988. :U.S. patent.
24. Rickman W.S. and Young J.E., "*Recent Developments Concerning Circulating Bed Combustion of Spent Potlinings*", Light Metals Symposium, .1987. : pp. 659-661.
25. Owen M Gardner, Ralph L Cheek, "*Treatment of Alumuum Reduction Cell Linings Combmed With Aluminum Scrap Reclamation*", U.S. patent 4,927,459, .1989.
26. Davis P.K. and Kakaria V.K., "*Method of Treating Fluoride-Contarninated Waste Aluminum Potliner*", .1986.: U S. patent.
27. William S. Rickman, James L. Kaae, Bernard W. Gamson, "*Method for the Combustion of Spent Potlining from the Manufacture of Aluminum*",.1987: U.S.patent .
28. William S. Rickman, "*Circulating Bed Combustion of Spent Potliners*",Light Metals Symposium", .1988.: pp. 735-743.
29. Personnet P.B., "*Treatment and Reuse of Spent Lining Materials from Aluminium Smelters*", .1991.
30. Alfaro I., "*Treatment of Spent Electrolytic Cells from Aluminium Production*",.1988.
31. Singh, G., et al., "*Removal of fluoride from spent pot liner leachate using ion exchange*", Water Environ. Res, .1999.: p. 71((Copyright (C) 2014 American Chemical Society (ACS). All Rights Reserved.):p.36-42.
32. Joseph B Cashman, "*Detoxifying aluminum spent pot liners for solid waste landfill*",USA .1998. WO1998030499 A1.
33. Wilkening S., "*Recovery of Aluminum Fluonde from Fluoride Wastes*".1990.
34. Nambiar K.R, et al., "*Study on Used Cathode Linings of Aluminium Pots*",Bull. Electrochem,.1987.: pp. 45-49.
35. Souza R., et al., "*Recovery of Components from Electrolytic Cell Wastes m Aluminum Manufacture*",.(14 December 1988).
36. Saterlay A.J., et al., "*Ultrasonically enhanced leaching: removal and destruction of cyanide and other ions from used carbon cathodes*", Ultrason. Sonochem.2000. ((Copyright (C) 2014 American Chemical Society (ACS).p. All Rights Reserved.):p. 1-6.
37. Margulis M.A., Russ. J., Physical Chem, .1969.: 43: p. 592.
38. Mason T.J., Ultrason. Sonochem., .1992. :p. 140.
39. Diego Fernández Lisbona, Karen M. Steel "*Recovery of fluoride values from spent pot-lining: Precipitation of an aluminium hydroxyfluoride hydrate*

- product*”, Sep. Purif. Technol., .2008. (61(Copyright (C) 2014 American Chemical Society (ACS). All Rights Reserved.): p. 182-192.
40. Ogbunike K.U., “*The treatment of spent potlining from the aluminium industry for the recovery of valuable co-products*”, .2004. (M.Sc. thesis, The University of Nottingham).
  41. Wood, D., et al., “*Method for detoxification of spent pot lining*”, The University of Melbourne, Australia, .2003.:p. 46 pp.
  42. Silveira B.I., Blasquez J.E., and Santos R.K.P., “*Characterization of inorganic fraction of spent pot liners: evaluation of the cyanides and fluorides content*”, Hazardous Materials, .2002. Vol. 89, No. 2-3:pp. 177–183.
  43. *Alcoa Worldwide Sustainability: Sustainability of Operations: Environmental: Emissions&Waste,2012*,[http://www.alcoa.com/sustainability/en/info\\_page/operations\\_env\\_emissions.asp](http://www.alcoa.com/sustainability/en/info_page/operations_env_emissions.asp), viewed on 1st March, 2012.
  44. *Alcoa in Australia: Environmental Management: Waste, 2012*,[http://www.alcoa.com/australia/en/info\\_page/environ\\_waste.asp](http://www.alcoa.com/australia/en/info_page/environ_waste.asp),viewed on 1st March, 2012.
  45. Mikša D.M.H., Samec N., “*Spent potlining utilisation possibilities*”, Waste Manage Res, .2003. Vol. 21,:pp. 467– 473.
  46. Kohnen R.L., “*Disposal options for spent potliner*”,ERAtch Publications, .2012.
  47. Lechtenberg D., “*Spent cell linings from the aluminium smelting process as an alternative fuel and raw material for cement production*”,*Global Cement Magazine*, .2009.:pp.36-37.
  48. Hatakeyama T., “*Thermal Analysis: Fundamentals and Applications to Polymer Science*”, Second Edition, John Wiley and Sons, Chichester, UK, .1999. :pp.120-123.
  49. Siesler H. W.and Holland-Moritz K., “*Infrared and Raman Spectroscopy of Polymers*”, Marcel Dekker, .1980. Vol. 4:pp. 146-153.
  50. Sandler, S.R., Karo, W., Bonesteel, J. and Pearce, E. M., “*Polymer Synthesis and Characterization*”, Academic Press, San Diego, .1998.
  51. Haines P.J., “*Thermal Methods of Analysis: Principles, Applications and Problems*”, Blackie, London, .1995.
  52. Douglas L. Dorset and Mary P. McCourt,”*Polymer Analysis: Structure*”,John Wiley and Sons, Chichester, UK, .2002. :pp.164-165.
  53. Graham Currell, “*Analytical Instrumentation: Performance, Characteristics and Quality*”,John Wiley and Sons, Chichester, UK, .2000.:pp. 190-191.
  54. ALCOA, “*MATERIAL SAFTY DATA SHEE*”, .2012.
  55. Coates John, “*Interpretation of Infrared Spectra, A Practical Approach*”, *Encyclopedia of Analytical Chemistry*. .2000.: p. 10815–10837.
  56. Sasha Stankovich, Dmitriy A. Dikin, Richard D. Piner, Kevin A. Kohlhaas, Alfred Kleinhammes, Yuanyuan Jia, Yue Wu, SonBinh T. Nguyen, , , Rodney S. Ruoff, “*Synthesis of graphene-based nanosheets via chemical reduction of exfoliated graphite oxide*”, .2007. :pp. 1558–1565: p.Carbon 45, .
  57. Sungjin Park, Jinho An, Jeffrey R. Potts, Aruna Velamakanni, Shanthi Murali, Rodney S. Ruoff, “*Hydrazine-reduction of graphite- and graphene oxide*” ,.2011. Carbon 49.

58. Weiner R.A., & Matthews R.A., *Environmental engineering*(4th ed.). Amsterdam: Butterworth-Heinemann., .2003.
59. Stumm W., & Morgan, J. J. *Aquatic chemistry*. New York: Wiley.1996.
60. Babel S., & Kurniawan, T. A., "Low-cost adsorbent for heavy metals uptake from contaminated water: a review", *Journal of Hazardous Materials*, .2003. 97, 219–243.
61. Dias, J.M., Alvim-Ferraz, M. C. M., Almeida, M. F., and J. Rivera-Utrilla, & Sanchez-Polo, M., "Waste materials for activated carbon preparation and its use inaqueous-phase treatment: a review", *Journal of Environmental Management*, .2007. 85, 833–846.
62. Natale D., Erto A., Lancia, A., & Musmarra, D., "Experimental and modelling analysis of As(V) ions adsorption on granular activated carbon", *Water Research*, , 2008. 42, 2007–2016.
63. available, E.I.B.R.d.o.b., et al.
64. Leila Shahriary and Anjali a. Athawale, 'Graphene Oxide Synthesized by Using Modified Hummers Approach', *International Journal of Renewable Energy and Environmental Engineering*, 02 (2014), 58–63.
65. Ahmad Monshi, "Modified Scherrer Equation to Estimate More Accurately Nano-Crystallite Size Using XRD", *World Journal of Nano Science and Engineering*, .2012., 154–60.