

THE SIGNIFICANCE OF PERMEABILITY AND WETTABILITY CONTRASTS ON NEAR WELLBORE FLOW PATTERNS CREATING FORMATION DAMAGE EFFECTS

**Nadhah O Al-Marhoon*,
Carlos A Grattoni** and Richard A Dawe*****

*** Imperial College, London, UK**

****Petroleum Development, Oman**

*****Occidental Chair in Petroleum Engineering,
College of Engineering, University of Qatar.**

ABSTRACT

The majority of hydrocarbon reservoirs are heterogeneous and any geological model that is unable to represent these heterogeneities will not capture the correct displacement physics. In particular, difficulties are encountered in the near wellbore area because these heterogeneities significantly affect fluid flow displacement patterns. If the physics of flow in the near wellbore region is understood and if this physics is then honoured in a simulator, the predictions should be valid. This paper aims to improve the understanding of near wellbore flow in hydrocarbon reservoirs by experimental demonstration of the differences in flow and displacement behaviour between heterogeneous and homogeneous porous media and then to model them by numerical simulation.

The heterogeneity under investigation is due to permeability and wettability differences with both miscible and immiscible flow. Capillary and viscous force differences ensure that the boundaries create flow distortions. The differences are very significant and their neglect in the past has led to many costly failures in well-bore stimulation. Experiments such as those reported here can suggest where and how the fluid will flow from the reservoir to the wellbore on production or into the formation when injecting fluids for well clean-up. Predictions by simulator could then be made for near wellbore damage so that remedial treatments can be developed.

Keywords: Near Wellbore Flow, Reservoir Engineering, Formation Damage, Heterogeneities, Wettability

INTRODUCTION

The most important region of a producing reservoir is the zone within 5 metres of a wellbore. This near wellbore area is where the largest pressure drops occur. Clearly the near wellbore formation permeability significantly affects pressure profiles and hence well deliverability and production rates. How the fluids flow into the wellbore through the near well-bore zone is not properly known - it seems incredible that this is the case since all produced fluids have to flow through this zone.

The calculation of near wellbore pressure drops [1-6] using the standard assumptions of a homogeneous formation and radial flow is likely to be erroneous because:

- The near wellbore is heterogeneous (well logs suggest this),
- The near wellbore region is often damaged during drilling (mud filtrate invasion etc.), and during production [4] (fines movements, chemical scale etc.) so that its average permeability is less than the average of the reservoir.

Any deviation from the homogeneous case in these areas is covered in well test analysis by the general term 'skin effects' [1-3,5]. However, a skin factor will not tell the petroleum engineer all that needs to be known about the near wellbore region, particularly how to ensure that the well will produce at its maximum efficiency, or if a well stimulation treatment is placed correctly. The treatments to mitigate formation damage cost the oil industry many millions of dollars each year as shown in company balance sheets. Most wells drilled must be cleaned-up before being put on line. But even today exactly how and what route the fluids flow to the perforations and hence into the wellbore is not well understood. Clearly a good understanding of the nature of the permeability and flow within these areas is necessary for efficient production control. An understanding of the factors influencing formation damage in the near wellbore area will also assist the development of drilling and production methods which minimise the creation of damage, as well as improve the treatments used to remedy any damage.

In principle, numerical simulation can be used to investigate the detailed flow around the wellbore, but the ability of conventional finite difference methods to do this is not always convincing. Finite difference schemes are used world-wide to support multi-million dollar reservoir development decisions with the implicit assumption that the simulators correctly model the real flow patterns. Also the physical processes occurring even in regions where the permeability pattern is known is still far from clear, particularly for immiscible displacements. Additionally, if the understanding of the near wellbore flow can be incorporated

The Significance of Permeability and Wettability Contrasts...

into simulation, then the accuracy of the reservoir simulation and the characterisation of the reservoir itself should be improved. Experimental evidence describing flow in typical elements from around the well is needed to validate any near wellbore simulator. Formation damage in the near wellbore region will reduce pore sizes, which will reduce effective permeabilities. These reduced pore sizes will create boundaries, which can modify the flow from the radial form.

In this study both permeability and wettability contrast stripe models have been used to investigate near wellbore flow effects in both miscible and immiscible displacements. When a streamline passes through a boundary it will change its path direction in a manner similar to light refraction, Figure 1; the fluid will attempt to take a near parallel path in the high permeability region and a near perpendicular path in the low permeability one. Hence, when a fluid crosses the boundary between the two regions (from fine layer to coarse layer) refraction will occur. This in turn could decrease the effective cross sectional area after crossing the boundary towards the production well. In this study, permeability and wettability stripes have been under investigation, Figure 2. These stripes represent some of the heterogeneous structures that might be found in the near wellbore region. These could represent variations in permeability and wettability. Any effective permeability change because of different pore sizes, wettability changes, initial saturations, etc. can deviate the flow from the radial form. Understanding the physics of the real flow in this region is essential for better assessing the formation damage in terms of pressure drop and hence remedial well treatment, but this is clearly difficult to formulate. Also, when the cause of the skin is poorly identified, effective well treatments to improve well productivity are clearly unlikely to be efficient.

This paper aims to improve the understanding of near wellbore flow by experimental and demonstration of the differences in flow and displacement behaviour between heterogeneous and homogeneous porous media and to model them by numerical simulation. The heterogeneity under investigation is permeability and wettability changes. The differences in flow behaviour are very significant and their neglect in the past has led to the many reported (and unreported) failures in well-bore stimulation. This has proved very costly.

BASICS

The effective permeability is the rock property that controls the ability of a fluid to flow through a porous solid. The factors affecting the effective permeability include porosity, pore size distribution, pore geometry and pore tortuosity.

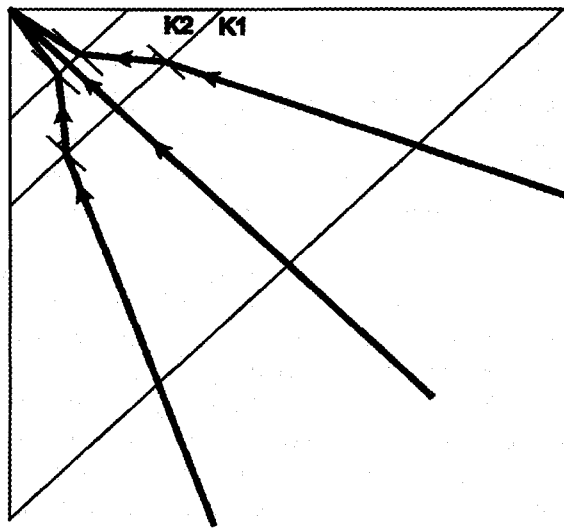

Streamlines through permeability stripes.

Fig. 1a. Crossing high permeability layer $K_2 > K_1$. The refracted streamline moves away from the normal to the boundary and tries to remain inside the high permeability layer.

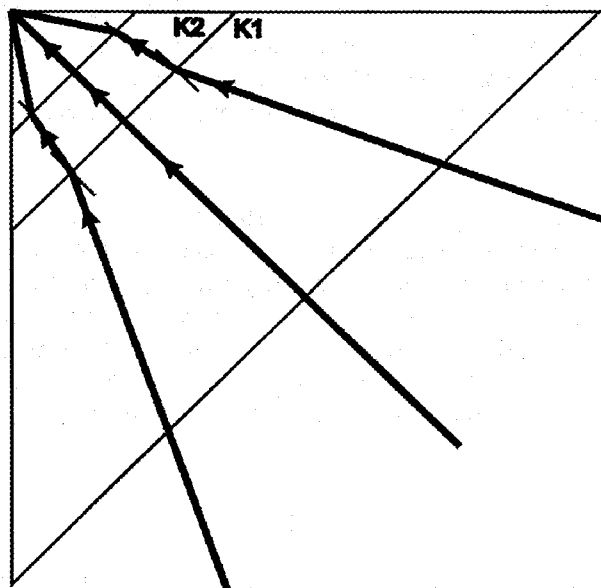

Fig. 1b. Crossing low permeability layer $K_2 < K_1$. The refracted streamline moves towards the normal to the boundary and tries to pass the low permeability layer as quickly as possible.

The Significance of Permeability and Wettability Contrasts...

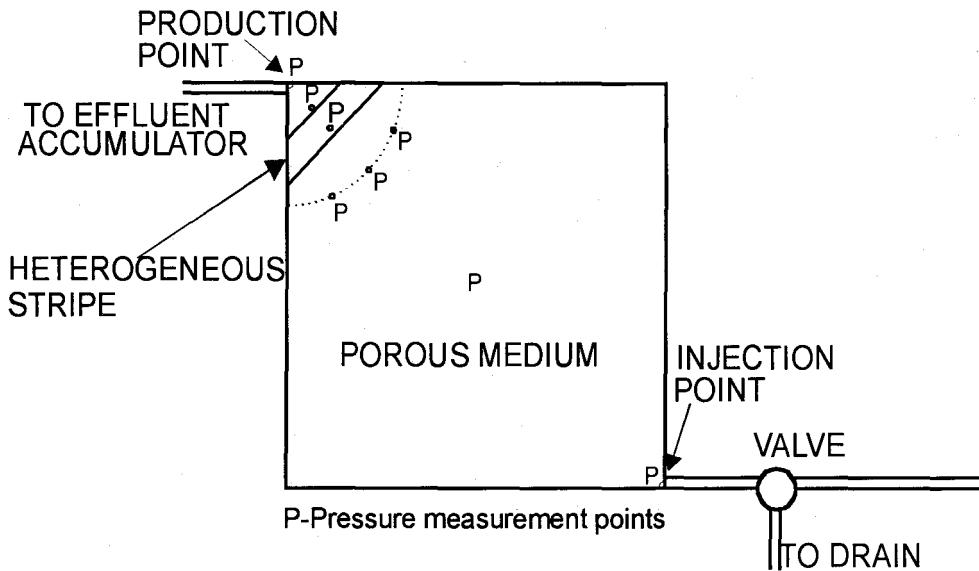

Fig. 2. Model pattern. The area marked 'heterogeneous stripe' can be an area of different permeability or different wettability compared to the rest of the model, which is itself homogenous. The points marked "P" are pressure tapping points.

Because of the similarity of fluid flow at a boundary to light refraction, the fluid will take a parallel path in high permeability region and a perpendicular path in low permeability one [11] and the high permeability region gives less impediment to flow. Therefore, during remedial treatment, the injected fluid is likely to flow to the higher permeability, possibly undamaged, region [12]. Diverting agents are used to divert (push) more fluid into the low (damaged areas) so as to attain a more uniform fluid distribution over the treatment interval. Quantifying reservoir permeability and skin factor is normally carried out by pressure analysis. Pressure transmission is a diffusive process [3] so is governed by average conditions rather than by local heterogeneities. Nevertheless, the local heterogeneities cause extra pressure drops, especially near the wellbore compared with the homogeneous case, and can completely change the displacement patterns.

Wettability is defined as the preference of one fluid (the wetting fluid) to spread on or adhere to a solid surface in the presence of other immiscible (non-wetting) fluids. In water-wet systems, water fills the small pores and coats most of the surface of the large pores while in oil-wet system, the reverse occurs. Wettability has significant effects on irreducible saturations and relative permeabilities. The factors affecting the wetting properties of the reservoir rock include rock mineralogy, oil composition, reservoir temperature and pressure as well as the pH

and composition of the reservoir brine [17]. However, wettability might change during drilling (e.g. mud compositions) or during production (e.g. pressure reduction and crude oil composition change). Such changes have not yet been fully investigated in the field. It is therefore very important to gain an understanding of the nature of the wettability changes in the near wellbore region (oil-wet, water-wet or variable) in order to be able to plan to minimise any effects of formation damage. If the reservoir wettability can be determined, its effects upon immiscible displacement could well be predicable.

APPROACH

This paper presents the near wellbore flow patterns, their impact on the recovery and discusses the successful simulation of the experimental work and the significance of the differences between experiment and the simulation. This work is a continuation of previous experimental and numerical studies conducted at Imperial College, London, [7-13]. In this current work some experiments with well defined near wellbore heterogeneities have been studied in two dimensional square visual models with glass beads, Figure 2. The flow patterns are disturbed by the heterogeneities. Dyed fluids were used to indicate streamlines and displacement fronts. Pressure drops were recorded when necessary. The effects of heterogeneities upon single and multiphase flow conditions in the near wellbore area were investigated, in order to evaluate how formation damage evaluation and/or mitigation can be more effectively carried out. The experimental results of the flow through different heterogeneous media are compared with simulation, and in particular highlight how different parameters (permeability, wettability, miscible flow and immiscible flow) impact upon the flow patterns and recovery [14-16]. The following aspects of near wellbore flow were considered:

- Non-uniform flow patterns arise from the distribution of heterogeneities,
- That flow patterns for immiscible flow can change with time.

EXPERIMENTAL SET-UP

In the experiments visual models packed with Ballotini glass beads have been used. These current studies on radial flow on formation damage evaluation follow on from previous studies of linear flow [7-13] of the effects of permeability/wettability contrasts under different flow mechanisms (including miscible flow with different mobility ratios). The models have the advantage that heterogeneities, including any required spatially varying permeability, relative permeability and wettability changes, can be built-in as required. Additionally, the permeability/wettability contrasts can be carefully controlled. The experiments

The Significance of Permeability and Wettability Contrasts...

therefore provide visual evidence of the flow patterns occurring within such heterogeneous porous media in the vicinity of the wellbore. Pressure distributions around this heterogeneous area show where the flow restrictions are likely to occur. The monitoring of saturation distributions within bead-packs is also relatively straightforward as described below.

The model is a two dimensional, square shaped sealed Perspex box (20cm x 20cm x 1.0cm). In order to get a radial flow a quarter of a five spot reservoir injection model was used. A schematic diagram of the experimental set-up is shown in Figure 3.

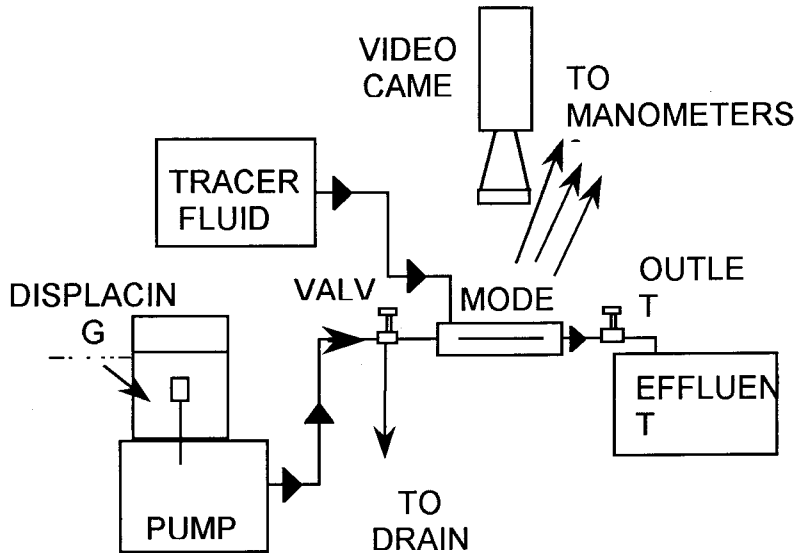

Fig. 3. Experimental set-up for displacement studies.

A permeability contrast area was created by using different grades of Ballotini beads (grade 6 (640-750 μm) for the higher permeability and grade 9 (310-425 μm) for the lower permeability), Figure 2. The absolute permeability of the glass beads was obtained by using Darcy's law in radial flow. The values were measured and found to be 270 D and 160 D for grade 6 and grade 9 respectively. The porosity of the bead-packs was determined by weighing before and after filling with water and found to be $40\% \pm 2\%$ for all models and grades of beads. Oil-wet areas were created by using beads coated with a water-repellent agent (dimethyl-dichlorosilane). Boundaries between different regions of permeability or wettability were formed during packing by inserting removable baffles. The pore volume of each model is approximately 160 ml. A pump (Altex) was used to drive the fluids at constant rates through the model. Full details have been given elsewhere [14].

Miscible displacements were performed by using water and viscous water (37% w/w glycerol). Immiscible displacements used water and oil (paraffin). The oil had a viscosity of 1.4 cp. and a density of 0.77 g/cm at 20°C. The experiments were conducted horizontally to minimise the influence of gravity forces due to the non-matched density fluid systems. Gas was not used due to the complexity of spreading and wetting effects [17].

The model was carefully packed with the required Ballotini beads. Carbon dioxide was then injected at low pressure through the packed bed to displace air. Then, degassed water was injected into the bed to displace and absorb the carbon dioxide. The fluids were dyed with Waxoline red or blue for oil, and Lissamine red or blue for water. These dyes were chosen for both the displacement patterns and the streamlines, because it was found that they give the clearest differentiation between the two phases, so allowing the displacements to be visually monitored. Streamline visualisation was obtained by injecting dyed fluids through septa in the top of the model. During fluid injection the exit end and the inlet end of the model were maintained at the same height level to ensure a constant datum level for pressure measurements. The pressure measurements were taken at points between injection and production points, as well as close to the production point as shown in Figure 2.

The experiments include both miscible and immiscible displacements. The displacement procedure involved the following steps: flooding the model with viscous fluid at 5ml/min, injecting normal water to clean the model from the viscous fluid, injecting the model at fully water saturation with oil at 5ml/min, flooding the model at very high rate to obtain irreducible water saturation, and then injecting with water at 5ml/min. At the end, residual oil conditions were obtained [14]. Wettability heterogeneities do not have an effect on miscible displacements because beads of similar dimensions were used for both areas so clearly will have the same absolute permeability, but have large effects in immiscible displacements as will be shown later.

SIMULATION

Simulations have been carried out using the Eclipse numerical simulator [18]. When the flow is not aligned with grid orientation, inconsistent results can occur from the calculation of transmissibilities with a standard 5-point finite difference scheme. A nine-point scheme or curvilinear grids could then be the best method for the scheme for the quarter of the five spot model but more computational time is needed [19]. However as all the floods were stable displacements, the simple 5-point finite difference method with small grid sizes was sufficient to capture the local heterogeneities without significant computational error due to grid

The Significance of Permeability and Wettability Contrasts...

orientation. In fact as discussed later, the simulation flow patterns were found to follow the experimental patterns and that the experimental and simulation recovery profiles were in good agreement.

RESULTS AND DISCUSSION

Base Case – Homogeneous system.

Base case experiments to define and clarify the pressure distribution and flow streamlines for miscible/immiscible fluid displacements where there is no formation damage (zero skin effects) were performed with a model filled with one size of bead (homogeneous system), Figure 4. These experiments established the base case for all the experiments with permeability and wettability contrasts, and for the simulation work. Figure 4 illustrates the radial flow patterns and flow streamlines for both miscible and immiscible flow in the homogeneous model. The five spot model has a double radial system. The fluid front moved from the injector in a radial form for 40% of the total distance between the injector and producer, and then the radial form re-appears again at 40% away from the producer. In the middle the radial flow patterns change due to the changes in the driving force (pressure) and fluid dispersion. Also the streamlines go by the shortest path from the injection point to the outlet. Most of the pressure drop occurs near the wellbore because of the decreasing cross sectional area in the near wellbore region. It is not due to damage for this homogeneous case; the closer to the wellbore the smaller the cross section so more pressure is required to keep the same flowrate. The pressure distribution for the immiscible displacement have a similar profile to the miscible displacement.

In this paper an example of each of the high and low permeability stripe and wettability contrast stripe cases are described. Other cases are reported in reference [14].

Permeability contrast cases.

The flow patterns for miscible displacement were similar to the homogeneous model, and fluid fronts moved in a radial form near the injection and production points, but the fluid refracts (deviating from the radial form) when it reaches the stripe boundary, Figure 5. In the high permeability stripe this causes a narrowing of the streamlines close to the production point (Figure 5a). As a consequence, the pressure curves changed showing a greater pressure gradient in this zone compared with the homogeneous case. For immiscible flow capillary pressure effects occur at the boundaries and the interpretation becomes much more involved. For instance when oil flooding a water-filled model, the oil started to fill the high permeability stripe once it got to it (Figure 5a). Eventually, much of the water in the model was swept except some water was left (bypassed) upstream and downstream of the

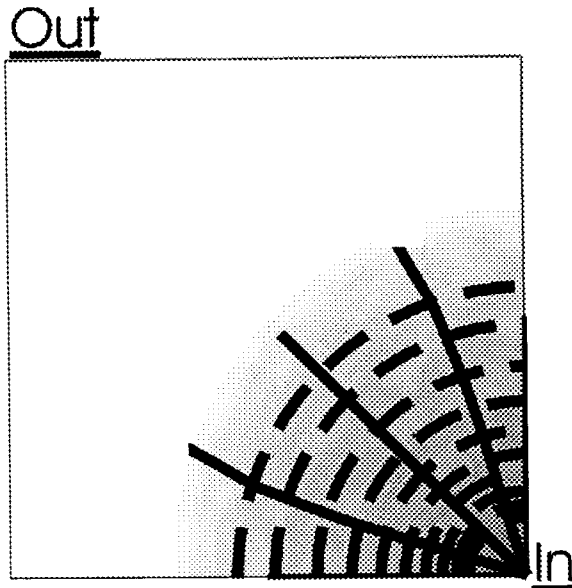

Homogeneous displacement

Fig. 4a. Start of Injection

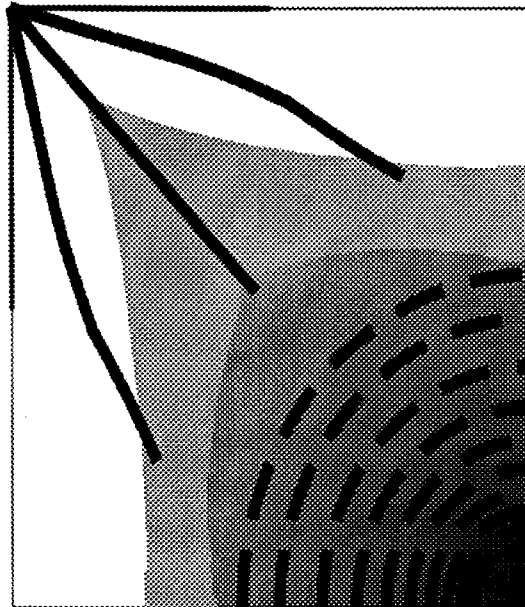

Fig. 4b. Displacement approaching outlet

The Significance of Permeability and Wettability Contrasts...



Fig. 4c. After injection of three pore volumes

The change in darkness of shading indicates the dispersed nature of the displacement front and the saturation in gradients.



Immiscible displacement mid-under waterflood

Fig. 5a. High permeability stripe

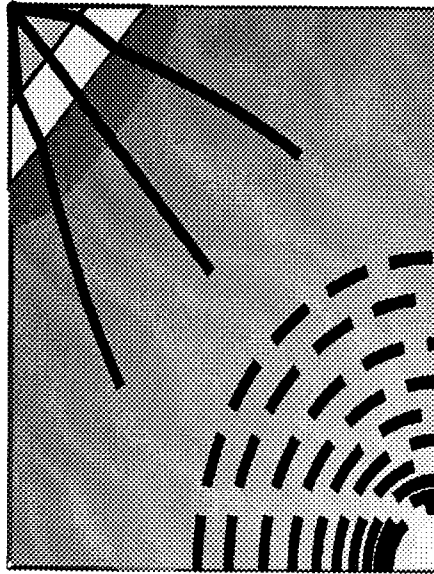

Fig. 5b. Low permeability stripe

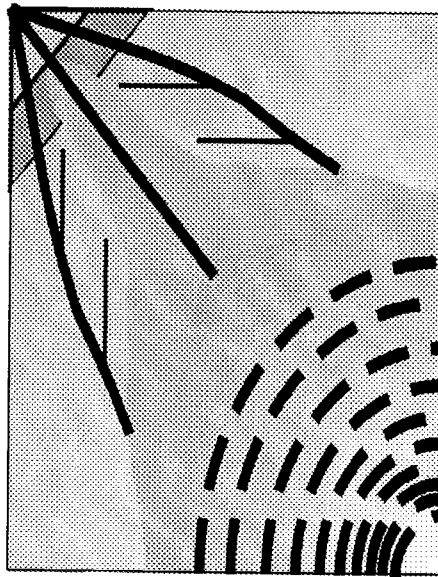

Fig. 5c. Wettability contrast

The change in darkness of shading indicates the dispersed nature of displacement front and the saturation in gradients.

The Significance of Permeability and Wettability Contrasts...

stripe. This may be due to the increase in the capillary forces between low and high permeability regions as shown by Caruana and Dawe [8], and the decrease in the effective cross sectional radial area (narrowing streamline paths). Following on with a waterflood, the water crosses the high permeability stripe rapidly. However, as the flow progressed water started to replace oil in the stripe. At the end of the flood some oil was trapped just before the stripe. This is may be due to refraction in the boundary, producing a narrowing of the cross sectional area.

Wettability contrast case.

The flow patterns found in the oil-wet stripe model were different to the permeability stripe model. For the miscible displacement there was no noticeable fluid refraction in the oil-wet stripe. However, when oil flooding, as soon as the oil reached the oil-wet region, the oil rapidly filled it, leaving a large unswept area before the stripe. Careful study of the streamline patterns and pressure profiles showed that high pressure drops resulted from this pattern as the flow was restricted to the central part of the stripe (Figure 5c). The oil movement was mainly along the shortest diagonal path between injection and production points.

This restriction of movement was possibly due to the capillary difference between the different wettability regions and an increasing control of the viscous forces as the cross sectional area decreases. During waterflooding most of the oil in the water-wet regions was recovered. However, in the oil-wet stripe the water flow was restricted to the central part, following the shortest path across it.

Fluid production and recoveries.

The effluent from the oilflooding and waterflooding displacements was collected and analysed to follow the evolution of the recovery process. A typical simulation and comparison is shown in Figure 6a. Fuller results are available [14]. It was observed that in both oil and water floodings, the High Permeability Stripe model has an early breakthrough and less total recovery. During oilflooding the presence of the high permeability stripe caused a reduction of 30% recovery at breakthrough and the residual saturation is 13 % lower compared than with the homogeneous case. The recovery is controlled by the permeability order near the well and the balance between viscous-capillary forces. In the high permeability stripe model the permeability order induces a reduction of the effective cross sectional area, increasing the importance of the viscous forces and reducing the recovery (Figure 5a). In the low permeability stripe model there is an increase of the cross sectional area (Figure 5b) producing a delayed breakthrough and a lower residual saturation for the oilflooding compared with the homogeneous case (Figure 6b).

In the simulations it was found that the simulated recovery for the homogeneous cases shows almost the same behaviour as the experiments for oil flooding. Some

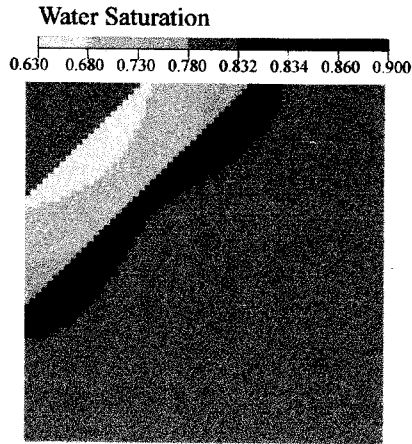

Simulation of waterflood at 3 pore volumes injected.

Fig. 6a. Displacement in 1/16 of the total area of the five spot; the changes in shading indicates changes in water saturation.

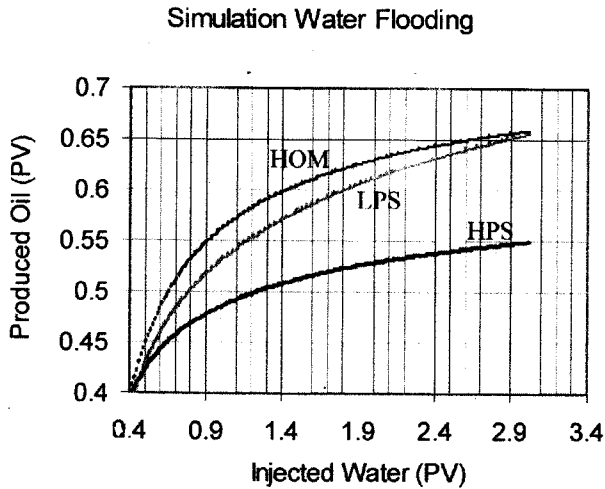

Fig. 6b. Oil recovery vs. pore volume injected (HOM-homogeneous; HPS-high permeability stripe; LPS-low permeability stripe).

larger but acceptable differences in oil recovery and breakthrough times increases were found for the water flooding case. Similar effects were observed for the high permeability stripe and low permeability stripe cases.

The Significance of Permeability and Wettability Contrasts...

CONCLUSIONS

- The experimental work demonstrates differences in flow and displacement behaviour between heterogeneous and homogeneous porous media.
- In the high permeability stripe heterogeneity situations, it was found that the displacing phase bypassed banks of the other phase just before the stripe. In oil flooding this is due to capillary effects at the edges of the first boundary (between the low and high permeability regions). In water flooding, this is due both to capillary effects (at the edges of the second boundary between high and low permeability regions) and the decrease in effective cross sectional area.
- In a wettability contrast stripe situation, the oil-wet stripe has more affinity to the oil and repels the water; a restriction to flow occurs once the displacing phase reaches the boundaries of the stripe. This effect is due to the interplay between viscous and capillary forces.
- Capillary and viscous force differences ensure that the boundaries 'of the stripe' have different effects in a high to low and a low to high permeability boundary. The second boundary in the high permeability stripe case creates a larger flow restriction.
- Most reservoirs are heterogeneous and any geological model which is unable to represent these heterogeneities will not capture the correct displacement physics. Difficulties are encountered in the near wellbore area because these heterogeneities significantly affect the radial fluid flow displacement patterns. (There is of course the further difficulty of building geological models due to the wide range of permeability variations and wettability changes). Experiments such as those reported here should tell us where and how the fluid will flow from the reservoir to the wellbore on production or into the formation when injecting fluids for well clean-up. With this physical appreciation of displacements coupled with some knowledge of the geological description in the near wellbore area, predictions can be made as to where damage may occur. From this knowledge stimulation or remedial action may be applied more efficiently by targeting the most affected areas. It must be remembered that the formation damage will change as the flow patterns change during production.
- If the physics of flow in the near wellbore region is understood, then flow in similar geometries could be conducted by simulator. If this physics is then honoured, then the predictions should validate the experiments. Predictions could then be made for near wellbore damage, and remedial treatments developed. This finding could also widen the vision in well testing interpretation.

ACKNOWLEDGEMENTS

The Authors would like to thank Petroleum Development Oman (PDO) for financial support and their encouragement and C. A. Grattoni thanks EPSRC for the award of a ROPA research contract.

REFERENCES

1. **Golan, M. and Whitson, C.H., 1986.** Well performance, IHRDC, Boston, USA.
2. **Horne, R. N., 1995.** Modern well test analysis- a computer aided approach, Second edition, Petroway Inc., Palo Alto, USA.
3. **Sabet, M.A., 1991.** Well test analysis, Gulf Publishing Company, Tulsa, USA.
4. **SPE Reprint Series No. 29, 1990.** Formation damage. Society of Petroleum Engineers, Richardson, Texas, USA.
5. **Van Everdingen, A.F., 1953.** The skin effect and its influence on the productive capacity of a well, Petroleum Transaction AIME, Vol. 198, pp 171-176.
6. **Burnett, D.B., 1994.** Using a physical wellbore model to study formation damage problems in well completions. SPE 27393, Symposium on Formation Damage Control, Lafayette, Louisiana, USA. 7-10 February, pp 495-504.
7. **Dawe, R. A., Wheat, M. R. and Bidner, M. S., 1992.** Experimental investigation of capillary pressure effects on immiscible displacement in lensed and layered porous media. Transport in Porous Media, vol. 7, pp 83-101.
8. **Caruana, A. and Dawe, R. A., 1996.** Experimental studies of the effects of heterogeneities on miscible and immiscible flow processes in porous media, Trends in Chemical Engineering, vol. 3, pp 185-203.
9. **Caruana, A. and Dawe, R. A., 1996.** Flow behaviour in the presence of wettability heterogeneities, Transport in Porous Media, Vol. 25, pp 217-233.
10. **Lambeth, N. and Dawe, R.A., 1987.** Viscous effects for miscible displacement in regular heterogeneous porous media. Chem. Eng. Res. Des. Vol. 65, pp 52-62.

The Significance of Permeability and Wettability Contrasts...

11. **Roti, Ø. And Dawe, R. A., 1993.** Modelling fluid flow in cross-bedded sections. *Transport in Porous Media*, vol. 12, pp 143-159.
12. **Evans, R.N. and Dawe, R.A, 1994.** The danger of neglecting nodal crossflow in heterogeneous near-wellbore conditions. *Journal of Petroleum Science and Engineering* 11, pp 113-121.
13. **McKean, H. C. and Dawe, R. A., 1990.** Numerical Simulation of Displacements in Systems containing a Lens Heterogeneous Porous Media. *J. Can. Pet. Tech.* Vol. 29, pp 88-93.
14. **Al-Marhoon, N. O., 1999.** The near well-bore flow behaviour for heterogeneous porous media, Ph.D. thesis, T.H. Huxley School, Imperial College, London University.
15. **Al-Marhoon, N. O., Grattoni, C. A., Dawe, R.A. and Carter, J. N. , 1998.** Formation Damage and near-Wellbore Flow in Reservoirs – An Experimental Study. 8th Abu Dhabi International Petroleum Exhibition and Conference Abu Dhabi, U.A.E., SPE 49499, 11-14 October.
16. **Al-Marhoon, N. O., Carter, J. N., Grattoni, C. A. and Dawe, R.A. ,1999.** Effects of Permeability Contrast in the Near Wellbore Flow Patterns - Comparison between Experimental and Numerical Studies, 11th. SPE Middle East Oil Show, Bahrain, SPE 53375, 20-23 February.
17. **Grattoni, C.A., Pingo Almada, M.B and Dawe, R.A., 1997.** Pore and core-scale displacement mechanisms with spreading and wetting effects during three phase flow. VLACPEC, Rio de Janeiro, Brazil, SPE 39032, 30 August - 3 September.
18. **Eclipse 100**, Technical Description, 97A, GeoQuest Reservoir Technologies, Chapter 5, 2-3.
19. **Lambeth, N. and Dawe, R.A., , 1988.** Boundary and Crossflow Behaviour during Displacement in Nodal Systems, *SPE Reservoir Engineering*, 3, 1137-1142.