

QATAR UNIVERSITY

COLLEGE OF ENGINEERING

FRAMEWORK FOR 'SPORTS' INFRASTRUCTURE ASSETS MANAGEMENT AND  
TRANSFORMATION POST-2022 WORLD CUP ADAPTING PPP MODULE -  
CRITICAL SUCCESS FACTORS

BY

ALBARA KHALEEL SULIEMAN ABUKESHEK

A Thesis Submitted to  
the Faculty of the College of Engineering  
in Partial Fulfillment of the Requirements for the Degree of  
Masters of Science in Engineering Management

June 2021

© 2021 Albara Abukeshek. All Rights Reserved.

## COMMITTEE PAGE

The members of the Committee approve the Thesis of  
Albara Abukeshek defended on 15/04/2021.

---

Murat Gunduz

Thesis/Dissertation Supervisor

---

Galal Abdella

Thesis/Dissertation Co-Supervisor

---

Mohamed Bin Mokhtar Kharbeche

Committee Member

---

Rifat Sonmez

Committee Member

Approved:

---

Dr Khalid Naji, Dean, College of Engineering

## ABSTRACT

ABUKESHEK, KHALEEL, ALBARA, Masters : June : 2021.,

Masters of Science in Engineering Management

Title: Framework for 'Sports' Infrastructure Assets Management and Transformation  
Post-2022 World Cup Adapting PPP Module – Critical Success Factors

Supervisor of Thesis: Gunduz, Murat.

The research aims to study the importance and the effect of the critical success factors that are important to engage the private party resources to assist the public party objectives from both parties' perspectives under the Public-Private Partnership arrangement (PPP). The study area is the Social type of Infrastructure - Sports assets related to a specific event as these assets' usage usually becomes a burden for the public party when there is no clear view of how they intend to be used once the event is completed. Engaging the private party on the project lifecycle under the PPP module will have benefits from sustainable development perspectives and more efficient assets management on top of the commercial gains for both public and private bodies. Based on a literature review, these factors will be identified, then categorized into groups. A total of 35 factors categorized under eight groups had been selected and formed into an online survey where experts from all over the world had given their inputs in the survey. The survey results were analyzed using the structural equation model method and relative importance index to identify the weightage and the importance of each of the 35 factors and groups.

The results indicated that the finance-related factors are the most critical factor for both public and private bodies, followed by Risk Factors, Operation, Legal, Stakeholders,

Construction, Design and Sports related Factors came last. The research recommends that the public party consider the groups' importance when drafting a framework and tender documents for sports assets linked with event-specific use. Also, to assume the same while evaluating the same. The private party also needs to consider the hierarchy obtained. It also represents the public party view and focuses on understanding the importance and the best way to tackle these groups.

*Key Words: Sports infrastructure, white elephants, Asset Management, Public-Private Partnership, Critical Success Factors (CSF), Sustainable Development*

## DEDICATION

*This thesis is dedicated with thanks to All-mighty Allah to my beloved parents, who were the Moon in my nights and the Sun in my days; My wife who encouraged me to pursue this trip; My Brothers and Sisters who supported me in my study; and at last, to my lovely daughters who supported me over the whole journey.*

## ACKNOWLEDGMENTS

With All Mighty Allah's help for his blessings, I express my most tremendous gratitude and appreciation for the support received from my supervisor, Prof. Murat Gunduz, Dr Galal Abdella, Dr Khalid Naji and Mr Stephen Humphry during the preparation of this master thesis.

I am also appreciative of my friends support, colleagues and professionals who participated in the survey conducted as part of this thesis.

## TABLE OF CONTENTS

DEDICATION .....	v
ACKNOWLEDGMENTS .....	vi
LIST OF TABLES .....	xii
LIST OF FIGURES .....	xvi
LIST OF GRAPHS .....	xviii
Chapter 1: INTRODUCTION.....	1
1.1 Introduction & Background .....	1
1.2 Research Aims and Objectives.....	3
Chapter 2: Literature Review .....	5
2.1 Infrastructure Definition.....	5
2.2 Hosting Mega Sports Events .....	6
2.3 Mega-Events and White Elephants .....	7
2.4 Using the Public-Private Partnership module .....	9
2.4.1. An infrastructure PPP .....	10
2.4.2. A Service PPP.....	10
2.5 Framework for Public-Private Partnerships .....	11
2.6 Critical Success Factors for the framework .....	13
2.6.1 Stakeholder related Factors .....	13
2.6.2 Risk related Factors .....	15

2.6.3 Finance related Factors .....	16
2.6.4 Legal related Factors .....	17
2.6.5 Design Related Factors .....	19
2.6.6 Construction-related Factors.....	21
2.6.7 Operation related Factors.....	22
2.6.8 Sports-related Factors .....	23
2.7 Summary of the Critical Success Factors and Groups .....	24
Chapter 3: Research Methodology.....	28
3.1 Introduction .....	28
3.2 The Research Question.....	28
3.3 The Research Approach/Strategy.....	30
3.3.1 The Research Method.....	30
3.3.2 Data Collection model .....	31
3.3.3 The Research Design Process.....	31
3.4 Response Strategy and Scaling .....	32
3.5 Sample size.....	32
3.6 Catering for partial responses and Non-Serious Responses (outliers) .....	33
3.7 Research Hypothesis .....	33
Chapter 4: Data Analysis .....	35
4.1 Introduction .....	35



4.2 Descriptive Analysis - Respondent's profiles.....	36
4.3 Descriptive Analysis – Original Data.....	42
4.3.1 Individual Critical Success Factors .....	42
4.3.2 Critical Success Factors Groups .....	54
4.3.3 Relative Importance Index (RII) – Original Data.....	55
4.4 Collected Data and Data treatment.....	58
4.4.1 Test for Outliers.....	58
4.4.2 Test for Normality .....	65
4.5 Descriptive Analysis – Modified Data.....	68
4.5.1 Individual Critical Success Factors .....	68
4.5.2 Critical Success Factors Groups .....	77
4.5.3 Relative Importance Index (RII) – Modified Data .....	79
4.6 Advanced Statistical Analysis.....	84
4.6.1 Proposed Model Analysis.....	86
4.6.2 Modified Model Analysis (1st Order Degree).....	91
4.6.3 Structural Equation Model (2 <sup>nd</sup> Order Degree) .....	97
4.6.4 SEM Ranking .....	102
4.6.5 Ranking (SEM V.s. RII).....	107
4.7 Individual Critical Success Factors Overall effective weight .....	108
Chapter 5: Results, discussion and recoMmendation .....	110

5.1 Introduction .....	110
5.2 Discussion of Results .....	110
5.2.1 Testing the Hypothesis .....	110
5.3 Ranking of Critical Success Factors.....	111
5.3.1. Finance Related Factors .....	112
5.3.2. Risk-Related Factors.....	112
5.3.3. Operation Related Factors .....	113
5.3.4. Legal Related Factors .....	114
5.3.5. Stakeholders Related Factors.....	115
5.3.6. Construction-related Factors.....	115
5.3.7. Design Related Factors .....	116
5.3.8. Sports-Related Factors.....	117
5.4 Conclusion.....	118
5.5 Recommendations .....	119
5.5.1 Finance Related Factors recommendations .....	121
5.5.2. Risk-Related Factors recommendations .....	121
5.5.3. Operation Related Factors recommendations.....	121
5.5.4. Legal Related Factors recommendations.....	122
5.5.5. Stakeholders Related Factors recommendations .....	123
5.5.6. Construction Related Factors recommendations .....	123

5.5.7. Design Related Factors recommendations .....	124
5.5.8. Sports-related Factors recommendations.....	124
References.....	127
Appendix 1: Survey Questionnaire.....	132
Appendix 2: Normality Distribution among factors and groups .....	141

## LIST OF TABLES

Table 1. Fifa World-cup 2014 in Brazil stadiums delivery modules.....	9
Table 2. Summary of Critical Success Factors and References.....	25
Table 3. Identified Critical Success Groups and Factors.....	28
Table 4. Response sample and scaling.....	32
Table 5. Respondents Organizations Categories .....	36
Table 6. Respondents Sector Experience.....	37
Table 7. Respondents Rules.....	38
Table 8. Respondents Area(s) of Expertise.....	39
Table 9. Respondents Type of Projects Experiences .....	40
Table 10. Respondents total number of years of working experience.....	41
Table 11. Critical Success Factors groups and items coding.....	43
Table 12. Response Criteria and coding .....	44
Table 13. Stakeholder Group Factor responses – Original Data .....	44
Table 14. Risk Group Factor responses – Original Data .....	45
Table 15. Finance Group Factor responses – Original Data.....	46
Table 16. Legal Group Factor responses – Original Data .....	47
Table 17. Design Group Factor responses – Original Data .....	48
Table 18. Construction Group Factor responses – Original Data.....	49
Table 19. Operation Group Factor responses – Original Data.....	50
Table 20. Sports Group Factor responses – Original Data .....	51
Table 21. Summary of the highest responses on the Critical Factors – Original Data	52
Table 22. Summary of the group responses on the groups – Original Data .....	54
Table 23. individual Critical Success Factors Ranking using RII – Original data .....	56

Table 24. Critical Success Factors Groups using RII – Original Data .....	57
Table 25. Response Criteria and coding .....	58
Table 26. Observations farthest from the centroid (Mahalanobis distance) – Individual factors.....	61
Table 27. Outliers result from the SPSS software – Individual factors .....	62
Table 28. Observations farthest from the centroid (Mahalanobis distance) – Group Factors.....	63
Table 29. Outliers analysis – individual and group factors .....	64
Table 30. Skewness and Kurtosis results – Individual Critical Success Factors .....	66
Table 31. Non-normality individual critical success factors .....	67
Table 32. Skewness and Kurtosis results – Critical Success groups .....	67
Table 33. Stakeholder Group Factor responses – Modified Data.....	68
Table 34. Risk Group Factor responses – Modified Data.....	69
Table 35. Finance Group Factor responses – Modified Data .....	70
Table 36. Legal Group Factor responses – Modified Data.....	71
Table 37. Design Group Factor responses – Modified Data.....	72
Table 38. Construction Group Factor responses – Modified Data .....	73
Table 39. Operation Group Factor responses – Modified Data.....	74
Table 40. Sports Group Factor responses – Modified Data.....	75
Table 41. Summary of the highest responses on the Critical Factors –Modified Data	76
Table 42. Summary of the group responses on the groups – Modified Data.....	77
Table 43. Individual Critical Success Factors Ranking using RII – modified data.....	79
Table 44. Critical Success Factors Groups using RII – modified data .....	80
Table 45. Comparison between RII and ranking between Original and modified data –	

Individual Factors .....	81
Table 46. Comparison between RII and ranking between Original and modified data – Groups.....	82
Table 47. Group RII based on individual Critical Success Factors .....	82
Table 48. Final ranking for groups based on average RII.....	83
Table 49. Model Fitness Parameters .....	85
Table 50. Proposed model fitness - individual Critical Success Factors .....	88
Table 51. Covariances - individual Critical Success Factors.....	88
Table 52. Proposed model fitness - Group Critical Success Factors .....	91
Table 53. Covariances - Group Critical Success Factors.....	91
Table 54. Modified model fitness - Individual Critical Success Factors.....	93
Table 55. Assessment of Modified Model Normality – Individual Critical Success Factors.....	93
Table 56. Modified model fitness - Group Critical Success Factors .....	95
Table 57. Assessment of Normality – Critical Success Factors Groups.....	96
Table 58. Final model fitness - Individual Critical Success Factors.....	99
Table 59. Assessment of Final Model Normality – Individual Critical Success Factors .....	99
Table 60. Final Model CR, AVE (reliability and validity estimates) - Individual Critical Success Factors .....	101
Table 61. The validity Test - Critical Success Factors Groups.....	101
Table 62. Correlation value between latent Variable - Critical Success Factors Groups .....	102
Table 63. The reliability Test - Critical Success Factors Groups .....	102

Table 64. Effective weight and ranking between the constructs (groups).....	103
Table 65. Effective weight and ranking among constructs between the latent variables (Critical Success factors) .....	103
Table 66. Overall Effective weight and ranking between the latent variables (Critical Success factors).....	104
Table 67. latent variables (critical success factors) based on the overall effective weight .....	105
Table 68. Overall Effective Weight for All Indicators .....	105
Table 69. Effective weigh and ranking - Critical Success Factors Groups .....	106
Table 70. Overall group ranking (average) using SEM.....	107
Table 71. Group Ranking comparison .....	107
Table 72. Effective weight and Ranking of all Individual Factors .....	108
Table 73. the Hypothesis Statement.....	110
Table 74. Overall group ranking (average) using SEM.....	111
Table 75. Effective weight and Ranking of Finance Related Factors.....	112
Table 76. Effective weight and Ranking of Risk-Related Factors.....	113
Table 77. Effective weight and Ranking of Operations Related Factors.....	113
Table 78. Effective weight and Ranking of Legal Related Factors .....	114
Table 79. Effective weight and Ranking of Stakeholders Related Factors.....	115
Table 80. Effective weight and Ranking of Construction Related Factors.....	116
Table 81. Effective weight and Ranking of Design Related Factors.....	116
Table 82. Effective weight and Ranking of Sports-Related Factors.....	117

## LIST OF FIGURES

Figure 1. DBFOM Procedure.....	19
Figure 2. Research Methodology .....	31
Figure 3. Respondents Organizations Categories .....	37
Figure 4. Respondents Sector Experience .....	38
Figure 5. Respondents Rules.....	39
Figure 6. Respondents Area(s) of Expertise .....	40
Figure 7. Respondents Type of Projects Experiences.....	41
Figure 8. Respondents total number of years of working experience.....	42
Figure 9. Stakeholder Group Factor responses – Original Data .....	45
Figure 10. Risk Group Factor responses – Original Data.....	46
Figure 11. Finance Group Factor responses – Original Data.....	47
Figure 12. Legal Group Factor responses – Original Data .....	48
Figure 13. Design Group Factor responses – Original Data.....	49
Figure 14. Construction Group Factor responses – Original Data.....	50
Figure 15. Operation Group Factor responses – Original Data .....	51
Figure 16. Sports Group Factor responses – Original Data.....	52
Figure 17. Summary of the group responses on the groups - Original Data .....	55
Figure 18. Summary of the group responses on the groups (Radar) – Original Data..	55
Figure 19. First SEM model – Individual Factors .....	59
Figure 20. First SEM model results – Individual factors.....	60
Figure 21. First SEM model – Group Factors.....	62
Figure 22. First SEM model results – Group Factors .....	63
Figure 23. Stakeholder Group Factor responses – Modified Data.....	68



Figure 24. Risk Group Factor responses – Modified Data .....	69
Figure 25. Finance Group Factor responses – Modified Data .....	70
Figure 26. Legal Group Factor responses – Modified Data.....	71
Figure 27. Design Group Factor responses – Modified Data .....	72
Figure 28. Construction Group Factor responses – Modified Data .....	73
Figure 29. Operation Group Factor responses – Modified Data.....	74
Figure 30. Sports Group Factor responses – Modified Data .....	75
Figure 31. Summary of the group responses on the groups – Modified Data .....	78
Figure 32. Summary of the group responses on the groups (Radar) – Modified Data	78
Figure 33. Proposed Model – Individual Critical Success Factors .....	87
Figure 34. Proposed Model – Group Critical Success Factors .....	90
Figure 35. Modified Model – Individual Critical Success Factors .....	92
Figure 36. The Modified Model Bootstrap Distribution - Individual Critical Success Factors.....	94
Figure 37. Modified Model – Group Critical Success Factors .....	95
Figure 38. The Modified Model Bootstrap Distribution - Critical Success Factors Groups.....	96
Figure 39. Final Model – Individual Critical Success Factors.....	98
Figure 40. The Final Model Bootstrap Distribution - Individual Critical Success Factors .....	100

## LIST OF GRAPHS

Graph 1. ST_1 Normality .....	141
Graph 2. ST_2 Normality .....	141
Graph 3. ST_3 Normality .....	141
Graph 4. ST_4 Normality .....	142
Graph 5. ST_5 Normality .....	142
Graph 6. R_1 Normality .....	142
Graph 7. R_2 Normality .....	143
Graph 8. R_3 Normality .....	143
Graph 9. R_4 Normality .....	143
Graph 10. F_1 Normality .....	144
Graph 11. F_2 Normality .....	144
Graph 12. F_3 Normality .....	144
Graph 13. F_4 Normality .....	145
Graph 14. F_5 Normality .....	145
Graph 15. L_1 Normality .....	145
Graph 16. L_2 Normality .....	146
Graph 17. L_3 Normality .....	146
Graph 18. L_4 Normality .....	146
Graph 19. D_1 Normality .....	147
Graph 20. D_2 Normality .....	147
Graph 21. D_3 Normality .....	147
Graph 22. D_4 Normality .....	148
Graph 23. C_1 Normality .....	148

Graph 24. C_2 Normality .....	148
Graph 25. C_3 Normality .....	149
Graph 26. C_4 Normality .....	149
Graph 27. C_5 Normality .....	149
Graph 28. O_1 Normality .....	150
Graph 29. O_2 Normality .....	150
Graph 30. O_3 Normality .....	150
Graph 31. O_4 Normality .....	151
Graph 32. O_5 Normality .....	151
Graph 33. S_1 Normality .....	151
Graph 34. S_2 Normality .....	152
Graph 35. S_3 Normality .....	152
Graph 36. Stakeholder Group Normality .....	152
Graph 37. Risk Group Normality .....	153
Graph 38. Finance Group Normality .....	153
Graph 39. Legal Group Normality .....	153
Graph 40. Design Group Normality .....	154
Graph 41. Construction Group Normality .....	154
Graph 42. Operation Group Normality .....	154
Graph 43. Sports Group Normality .....	155

## CHAPTER 1: INTRODUCTION

### 1.1 Introduction & Background

Countries aim to host mega-events to achieve specific goals, such as economic, political, among other plans. Holding such events will have its pros. However, the organizing committees of these events, such as FIFA, have a particular and sometimes complicated requirement to be in place by the hosting country to ensure successful event delivery.

These requirements can have different forms, and some of them can be categorized under either Social Infrastructure or Commercial Infrastructure. The costs of these Infrastructures assets vary depending on the type of event. Eventually, the hosting countries must make massive capital investments to comply with the Organizing committee requirements for hosting the event, dependent on the event's nature.

Once the event is completed, the commercial infrastructure will continue to operate normally despite the capacity gaps. In contrast, some social infrastructures assets built for the single usage of the event with no feasible usage plan after the event (such as Stadiums in the FIFA World cup event) and can become a burden since there is often very little use. The overhead costs, operation and maintenance costs force them into abandonment and disrepair post-event. Once they are abandoned, they are referred to as "White Elephants" that sit mostly empty after events have ended drain money from the public sector; this is due to the hindrance impacting the public party's financial capabilities in operating these assets.

Moreover, other challenges will occur for the private sectors acquiring new projects funded by the public party post-event, giving the significant investment in the event's

infrastructures. In some cases, these infrastructures are sufficient for a decade for the hosting country, resulting in Starving Infrastructure Market, which increases unemployment rates after the event, similar to what happened in South Africa. (Seymen, 2019)

One of the challenges for all countries is to manage the existing infrastructure assets that are available to ensure the best value for money is achieved for these assets. The 'best value of money' is the best combination of cost, quality and sustainability that meets the asset objective where:

1. Cost: The whole life cost of the asset.
2. Quality: Achieving minimum specification compliance and customers' requirements at the same time; and
3. Sustainability: The economic, social, and environmental benefits of the assets' program.

Several examples can be given to these assets that their objective is achieved, such as:

1. Assets that built and operated for a specific venue. Once the venue is completed, these assets will become a burden, and they will be no longer feasible at their current definitions to further operate and maintain and require repurposing.
2. Assets that built for a specific function in a pre-determined lifetime. Once its design lifetime is expired, they are no longer feasible to operate and maintain beyond that timeline.
3. Assets that built for a specific technology, while with time, these technologies become obsolete because of an unforeseen error in the feasibility study, but the assets lifetime is still valid.

One option is intended to be examined here in this study is to utilize the private party experience and resources (including financial resources) in the lifecycle of the assets in the form of partnership to reach the most innovative solution that can benefit both private and public party. This is called a Public-private partnership (PPP) relation.

PPP has several advantages. Studies show that PPP presented good value for money for Brazilian public administration, especially regarding the schedule, costs, diversified revenues, and bidding process due to incentive structures coming from contracts and private partner flexibility. (dos Reis & Cabral, 2017)

Moreover, PPP has been successfully implemented in Sports-related urban development. For example, the Singapore sports hub was built under a public-private partnership agreement. Another example is Telstra Stadium) in Australia and the Super Dome in Sydney, which were "build, own, operate, transfer" developments that is classified as PPP.

The benefits of partnership funding are that it explores and implements the creativity and innovation in design from the private party, providing better project viability. It balances risk and reward among project parties. (Yuen, 2012)

## 1.2 Research Aims and Objectives

This study focuses on a social type of infrastructure asset (Stadium) built for a specific venue where the research proposes to engage the private party in the lifecycle of these assets even after the event is completed.

Establishing a partnership between public and private parties is easy. It involves many factors that need to be understood and treated separately to ensure both parties receive this partnership's expected outcome.

These factors are categorized under Stakeholder, Finance, Risk, Legal, Design,

Construction, Operation, and Sports critical success factors groups and 35 factors distributed under them for the partnership between the public and private parties.

This study focuses on these success factors by doing qualitative research (survey) addressed to professionals worldwide and analyzing each factor's importance and weight based on the survey responses.

The results can form guidance to enhance the public-private partnership's current procedures. It will give the decision-makers and the policy writers and in-depth knowledge of what the private party and the public party are considering the most important for their partnership's success. (Zwikael & Globerson, 2006)

This will result in better utilization of existing assets in the partnership module through urbanization which eventually can benefit both private and public sectors in many ways to achieve more sustainable growth. Also, can enhance the construction of new facilities in term of cost, quality, and time due to the involvement of the private party financial resources and his ability to undertake risks that he manages appropriately on a more efficient way that the public party.

In principle, this research can set a road map and recommendations for the factors that need attention when PPP is an option for procuring. This is in line with Qatar University research priority and matching Qatar 2030 vision for more sustainable developments to overcome economic, social, and environmental challenges arising from these assets.

## CHAPTER 2: LITERATURE REVIEW

The main discussion under this chapter will focus on the past studies on the following matters:

- 1- Infrastructure Definition (Social - Sports).
- 2- The economic impact of hosting mega-events & Construction outlook post-events.
- 3- Public-Private Partnership and public sector investment.
- 4- Infrastructure asset management and urbanization.
- 5- Critical Success Factors for PPP.

The overall strategy to develop the PPP framework will pass through three stages as follows:

- The Short-term Strategy shows suitable measures for the two dimensions of the relationship between components and how to improve them.
- The Mid-term Strategy: shows the indirect influences from other incidental parts.
- Long-term strategy: this one is the overall "Framework" based on the historical experience, targeted requirements and so on.

### 2.1 Infrastructure Definition

The term "infrastructure" can be basic facilities, services. Its main objective is related to the community/society comfort, such as transportation and communications systems, water and power, schools, post offices, and prisons.



The word "infrastructure" means in general a:

- Complete systems or facilities such as highways and railroads
- Complete systems such as railroads but also including equipment such as rolling stock.
- Complete systems which include plant such as independent power production, wastewater treatment plants
- Social infrastructures such as hospitals, schools, and sports stadiums
- An economic infrastructure that relates to water, energy, transport, and telecommunications

Infrastructure can be categorized in two ways, either as economic or social. Public infrastructure assets may be classified into several sectors. The sports infrastructure (the study focus) is considered a type of social infrastructure asset where it is common to see examples of PPP developments with private finance.

## 2.2 Hosting Mega Sports Events

Hosting a major international sporting event ensures an exciting event and media attention for the host country and typically requires a substantial positive investment. The Federation Internationale de Football Association (FIFA) World Cup is one of these events' biggest. (Allmers & Maennig, 2009)

Developing countries have increasingly thrown their hats into the ring to host these mega-events in the last decade or so. The cost of running, organizing, and building infrastructure for an Olympic Games or World Cup, on the other hand, can be prohibitive, especially for developing countries lacking the same level of sports and tourism infrastructure as many developed nations. (Baumann & Matheson, 2013)

For example, In Germany 2006 World cup, The amount spent on sport facilities was estimated at 2 billion dollars out of 4 billion dollars associated with the event in which five new stadiums were constructed, and seven existing stadiums renovated and upgraded. The 2010 FIFA World Cup in South Africa cost approximately 3.9 billion dollars and spending between 1.3 billion and 2 billion dollars in constructing five new sports grounds and upgrading five existing stadiums. (Seymen, 2019). Still, venues used for these events after they are completed has gotten little coverage.

(Azzali, 2019) suggested that using local resources, fully integrating sports stadiums into the surrounding communities, and understanding the interrelationship between political power and activities would all contribute to positive legacies.

### 2.3 Mega-Events and White Elephants

Extreme resource misallocation appears to be a problem in developing countries. Both econometric and empirical studies indicate significant disparities in total factor productivity between developed and developing countries. (Robinson & Torvik, 2005).

Several mega sports event hosts have become acquainted with the word "white elephant" over the years. The definition can be traced back to ancient Thailand and other Asian countries. Holding a white elephant was an expensive endeavour, and the costs associated with it greatly outweighed its worth every day. (Alm, Solberg, Storm, & Jakobsen, 2016)

There have been several examples of the creation of white elephants because of inadequate assets planning post-events. For example:

- a) The Arena da Amazônia: Located in the city of Manaus, Brazil, the arena cost USD 220 million to build for the 2014 World Cup. The arena generated some

USD 180,000 in revenue for four months; it lost \$560,000 in the same period, leaving a deficit of nearly \$400,000 at one point in time built using the public fund.

- b) Cape Town Stadium: Built for the 2010 World Cup, Cape Town Stadium (in Cape Town, South Africa) cost the country \$600 million to build. Once the games had ended, the stadium began losing USD 8-10 million annually. Today, the stadium hosts the occasional concert and struggles to bring in any sustained revenue.

One choice is to follow China's lead, where public-private partnerships (PPPs) are increasingly being promoted to develop sports-related projects. The public-private partnership (PPP) model can create win-win outcomes for both public and private partners. (Chen, Zhao, Zhou, & Zhang, 2020)

The PPP approach might achieve the following benefits for both Public and Private parties as follows:

1. Sustainability for private-sector post venue as it is always expected that that construction trend will decrease post-venue.
2. Business attraction
3. Economic benefits
  - a. Minimize the expenses of the Capital cost
  - b. Minimize the expenses of O&M costs
  - c. Maximize economic benefits (the revenue) by allowing innovative ideas from the private sector.
4. Minimize Risks
5. Maximize O&M performance

The below table illustrates the gains achieved from adapting PPP in Brazil World cup 2014.

Table 1. Fifa World-cup 2014 in Brazil stadiums delivery modules

Stadium Name	Deliv. Type	SOW	Contract	Start of Work	Planned Delivery	Actual Delivery	Est.	Act.	Var. %
			Signing Date				Dur Mon	Dur. Mon	
Arena Castelão	PPP	Renov.	Nov2010	Dec2010	Apr.2013	Dec2012	29	24	83%
Arena Pernambuco	PPP	Constr.	Jun2010	Jan.2011	Jun.2013	Apr2012	36	34	94%
Arena das Dunas	PPP	Reconstr.	Apr2011	Aug2011	Dec.2013	Dec2013	32	32	100%
Arena Mineirão	PPP	Renov.	Dec2010	Jan2011	Dec.2012	Dec2012	24	24	100%
Arena BeiraRio	Private	Renov.	-	Jul2010	Dec.2013	Feb2014	41	43	105%
Arena Fonte Nova	PPP	Reconstr.	Jan2010	Jun2010	Dec.2012	Mar2013	36	39	108%
Arena Maracanã	PPP	Renov.	Aug-10	Aug-10	Feb.2013	May-13	30	33	110%
Arena Corinthians	Private	Constr.	-	May-11	Dec.2013	Apr-14	31	35	113%
Arena Mané Garrincha	Public	Reconstr.	Jul-10	Jul-10	Dec.2012	Jun-13	30	36	120%
Arena da Amazônia	Public	Reconstr.	Jul-10	Jul-10	Jun.2013	May-14	36	45	125%
Arena da Baixada	Private	Renov.	-	Oct-11	Jun.2013	May-14	21	30	143%
Arena Pantanal	Public	Reconstr.	Apr-10	May-10	Dec.2012	May-14	32	49	153%

It is worth noting that the Arena Fonte Nova Stadium was the only PPP project that exceeded the estimated initial implementation period due to FIFA's new requirements, whose launch (2011) of the new specifications took place after the signing of the PPP agreement (2010), leading to an increase in costs for the project. On the other hand, all other Stadiums were completed either on schedule or earlier (dos Reis & Cabral, 2017).

#### 2.4 Using the Public-Private Partnership module

The PPP model has been proven to be a desirable option for boosting infrastructural projects. (Chen et al., 2020)

A PPP is a Public-Private Partnership and is a method for procuring and delivering public assets, which are public works, subject or dedicated to public use or naturally accompanying or associated with public service provision. There are two types of PPP:

#### *2.4.1. An infrastructure PPP*

An Infrastructure PPP relates to contracts where the private partner is responsible for developing and managing new infrastructure.

#### *2.4.2. A Service PPP*

In a Service PPP contract, the private partner is responsible for managing existing infrastructure or only provides or operates public services, such as education or emergency services.

PPP can also be considered a delivery option for capital-intensive projects and additional intensive investment in an existing asset. This relates to the "significant upgrade or renovation", which part of asset repurposing or urbanization.

the broad definition used is one provided by the World Bank in 2014, which states that a PPP is:

A long-term arrangement between public and a private party(s) for the construction (or substantial improvement or renovation) and maintenance of a public asset, under which the private party assumes significant risk and management liability during the contract's life, and provides a considerable portion of the funding on its dime, where remuneration is strongly related to the success of the asset or service.

In other words, the PPP concept is a method for providing public infrastructure and, or public services as an alternative to conventional procurement.

Reasons for using a PPP may be classified into three main groups: financial; the second relates to efficiency and effectiveness; the final reason relates to other factors related to overall government efficiencies such as transparency and fairness.

Generally, there are six factors for incremental efficiency in a PPP as follows:

1. Cost management
2. Lifecycle cost management
3. Risk transfer
4. Innovation
5. Reliability and effectiveness
6. Utilization

## 2.5 Framework for Public-Private Partnerships

According to the World Bank's PPP Framework Definition, The legislation, processes, agencies, and rules that determine how PPPs will be applied, defined, evaluated, chosen, budgeted for, procured, tracked, and accounted for are referred to as the PPP framework.

In other words, The laws, defined processes, and institutional responsibilities decide how the government selects, implements, and manages PPP projects.

A PPP framework should include five essential elements.

### 1. Implementing Principles

The boundaries for using the PPP as a procurement option are defined by a collection of strategic and foundational outlines, including the overall goals for the scope, procurement and tender processes, and related regulations.

### 2. Operational Framework or Process Management Framework

This includes details on planning the PPP contract, the RFP structure, and the management of the tender and subsequent agreement, as well as a collection of

guidelines and procedures for identifying, preparing, and assessing or appraising projects.

3. Fiscal Management Framework

Describes the rules and procedures that control the PPPs' aggregated exposure.

4. Institutional Framework

Describes any government-specific rules relating to the management and governance of the PPP; and

5. Other Governance Related Matters

Other rules, processes, procedures, and responsibilities.

A sound PPP framework contributes to the success of a PPP project, and therefore the private sector is equally interested in the framework.

From the private sector's view, these four points are essential; the first three related to a PPP programme concept. Private sector PPP framework considerations:

- 1- Private developers are interested in markets that provide a pipeline of PPP projects. This offers the opportunity to generate economies of scale in bid preparation and management of tenders and projects.
- 2- Secondly, the framework will provide consistency. It ensures that different projects are structured and managed consistently, which lowers the private sector's costs and builds confidence in the market.
- 3- The third point relates to the private sector's need to be confident that the government can manage a pipeline and demonstrate a commitment to the PPP approach over the longer term.
- 4- Finally, concerns such as long-term fiscal sustainability, political commitment

to PPPs, societal acceptance of the tool, talent/experience retention, and a minimum legislative structure offering the opportunity to procure PPPs would affect the private sector. Many of these considerations affect the viability and preparation of each project. However, they do affect the PPP tool's long-term viability and reliability, as well as the nature of a proper pipeline.

## 2.6 Critical Success Factors for the framework

Critical success factors (CSFs) could be defined as the few vital areas of activity where favourable results are necessary for a manager to reach his/her goals. (Rockart, 1980). It is worth mentioning that the factors had been collected from previous researches related to the PPP module irrespective of their relevance to the sports infrastructure. Thus, the critical factors obtained here can be tailored to fit any type of infrastructure as the framework remains the same, while the details can vary based on the project location, objectives, and alike

In the research, eight groups of factors were identified as critical success groups: stakeholders, risk, finance, legal, design, construction, operation, and sports group. 35 factors have been placed under the eight groups based on their relevance (Osei-Kyei & Chan, 2015) as follows:

### *2.6.1 Stakeholder related Factors*

Numerous stakeholders are involved in the PPP decision who can positively and negatively influence the outcome and determine the module's success. The preliminarily identified stakeholders can be from the Public Sector, [such as the ministry of finance, ministry of law, ministry of interior, ministry of exterior (in case of international firms), ministry of planning and people and citizens (end-users)] or the Private sector stakeholders whom will be operating under the particular purpose vehicle



(SPV) [such as design consultants, construction contractors (EPC), project management and construction management firms, investors (banks), maintenance Contractors and operators. Accordingly, the paper identified five factors as critical success factors for the PPP implementation that relates to stakeholders:

The first factor was the *Clarity of roles and responsibilities among stakeholders*, where each party is aware of their roles and responsibilities, including timeframes and decision-making criteria. Abdul-Aziz et al. (2011), Jacobson C et al. (2008), Tang et al. (2013).

Secondly, the *Realistic sharing of income by stakeholders factor* was having a biased sharing of income will hinder the project success so that each party will focus on getting its investment returns earlier. Mladenovic et al. (2013), Partnerships UK (2006), Jacobson C. et al. (2008). Accordingly, and in the PPP protocol, the payment shares and flow must be clear, and the obligation for payment starts with O&M Contractor, followed by debts payments, then at last Equities can be paid.

*Public/community support to the project* was the third factor as it is critical as they are the project's end-users despite the delivery method. Li, B. et al. (2005), Gannon, M.J., Smith, N.J (2011), Zhang, X (2005).

The fourth factor was *Open and constant communication among stakeholders*, which is crucial to any project's success or failure despite the delivery module since miscommunication between project stakeholders can negatively impact and misinterpret the goals and objectives. Tang et al. (2012), Jacobson and Choi (2008), Tang and Shen, Q (2013).

Finally, the fifth factor, *Compatibility skills among stakeholders*, shall have enough

capacity and knowledge of this approach's objectives due to its complexity. In case of a lack of understanding and assigning non-competent skills for any part of the project, results might end with a project failure. Abdul-Aziz et al. (2011), Jefferies, M. et al. (2002).

### 2.6.2 Risk related Factors

The most identified CSFs are risk allocation and sharing, a robust private consortium, political support, community/public support and transparent procurement. (Osei-Kyei & Chan, 2015). Accordingly, four factors have been identified under the risk group,

Starting with *Appropriate risk allocation and sharing among stakeholders* as the first factor, which means managing threats to the project by the private party (in other words, it costs them money if they fail to manage the risk successfully), where it can be managed more effectively by the public partner, the risk should remain in the public domain for the success of the project.

The second and third factors identified; namely, the *Timely securing of necessary access permits factor* and *Timely access to the project site by the Project Company*, are related to the land permit and access depending on the project type as the previous use of the site as this affects the necessary permit application, [such as Greenfield projects, Brownfield projects or Yellow field projects]. The availability of the land and access to it are critical factors for the private sector as the financial model is built on a timely interest rate, which means that delays can affect the project's economic feasibility.

The fourth factor is related to *Effective operational risk management during the construction and Operation Stage factor*. The private party considers a specific value of Risk premium high at the construction stage and then decreases at the operation

stages. Monitoring the risks can influence the financial model and the cost of the project in total (Osei-Kyei, Chan, Javed, & Ameyaw, 2017)

### *2.6.3 Finance related Factors*

The financial aspects of PPP related to existing sports facility focus primarily on the asset's value from the public sector perspective as part of the investment, the transformation cost, which is a CAPEX cost, the operation and maintenance running cost (OPEX cost), which will govern the investment ROR, recovery period. Accordingly, five factors are shortlisted under this group.

It starts with *A competitive financial proposal by the Project Company* as the first factor. In some projects, there is no revenue generated by the users, for example, a hospital, or education, where the government funds these. Therefore, the government pays the contractor and, or investor instead of the users. This is a government that pays PPP or a PFI, Private Finance Initiative. However, it remains a public fund that needs to be located appropriately.

A government may wish the private party to manage the infrastructure's life cycle from construction to renewal or even more life cycles, finances the works with its funds, maintains or operates the infrastructure according to agreed service levels and performance requirements during the contract's life. The contractor or investor will be paid for both the construction and O&M only as long as, and to the extent that, the infrastructure is available according to the agreed availability and quality standards which are set.

In other words, to the agreed service levels hence, this needs to be captured in the RFP, and the competitive proposal and the revenue in this type of PPP results from service

provision to the grantor.

The second factor is *an effective payment mechanism to the Project Company during the operation stage factor* where due to the presence of external funding parties such as Banks (lender) investors, the payment mechanism has to be identified so each stakeholder can plan his cash flow and the period required for his return of investments.

The third factor was an *Effective life cycle cost analysis for the project by the Project stakeholders*. In a PPP project, the contractor is required to operate and maintain the asset. The capital expenditure is not repaid until the asset is operational when the contractor receives payments from the user or the government. Both of these factors encourage the contractor to build the infrastructure asset so that the ongoing operating and maintenance costs are reduced, which in the long terms increases the contractor's profit margins.

The fourth factor is the *government providing guarantees for the rate of return (ROR)* applicable in government pays PPP as there is no expectation for user revenue. It is to be noted that the PPP project return of investment (ROI) can be generated either from users (called user-pays PPP) or from the government (called government-pay PPP).

The fifth and last factor under this group is a *Stable macroeconomic condition* that is essential and critical for international investors. It is part of the risk analysis associated with any new investment. If the market is not stable, the risk is high, increasing the risk premium and the project cost subsequently, leading to the loss of the benefit of using PPP as a procurement model.

#### *2.6.4 Legal related Factors*

The country's laws within which we are implementing the framework will affect how

the PPP outcomes are achieved. Accordingly, four factors were identified, starting with the *Well-structured legal Framework during construction and operation stages* as the first factor here where a framework based on law can be stable and rigid as the scope for tailoring is limited. In many countries implementing a PPP, Framework involves extending the existing procurement procedures. In contrast, some frameworks are cohesively developed within a law or policy document and cover details of projects that may be formed as PPPs, information about the best way to implement the contract and the procurement process, project appraisal techniques and decision-making responsibilities and authority levels. At the other extreme, some PPP frameworks are just accommodated within the existing procurement laws. Irrespective of how we implement PPP frameworks, it will always be a challenge, and as we mentioned before. In summary, the framework needs to be tailored to suit the local environment and the project nature.

The second factor is a *Well written contract document protecting all project stakeholders* where standard contract approaches can be mutually agreed upon between public and private sectors. Different procurement strategies can be further studied that can be implemented, such as Build-Own-Operate-Transfer (BOOT), where the public sector grants a franchise to a private partner to finance, design, build and operate a facility for a specific period and the ownership of the facility is transferred back to the public sector at the end of that period. Another procurement method is Design-Build-Finance-Operate/Maintain (DBFO, DBFM or DBFO/M), in which the contractor designs, builds and maintain the facilities.

The third factor, which is critical from a private party perspective, is related to *the well-defined bidding process for the project*. This is critical because the bidding process

determines the procuring party's maturity and the chances for the project's success.

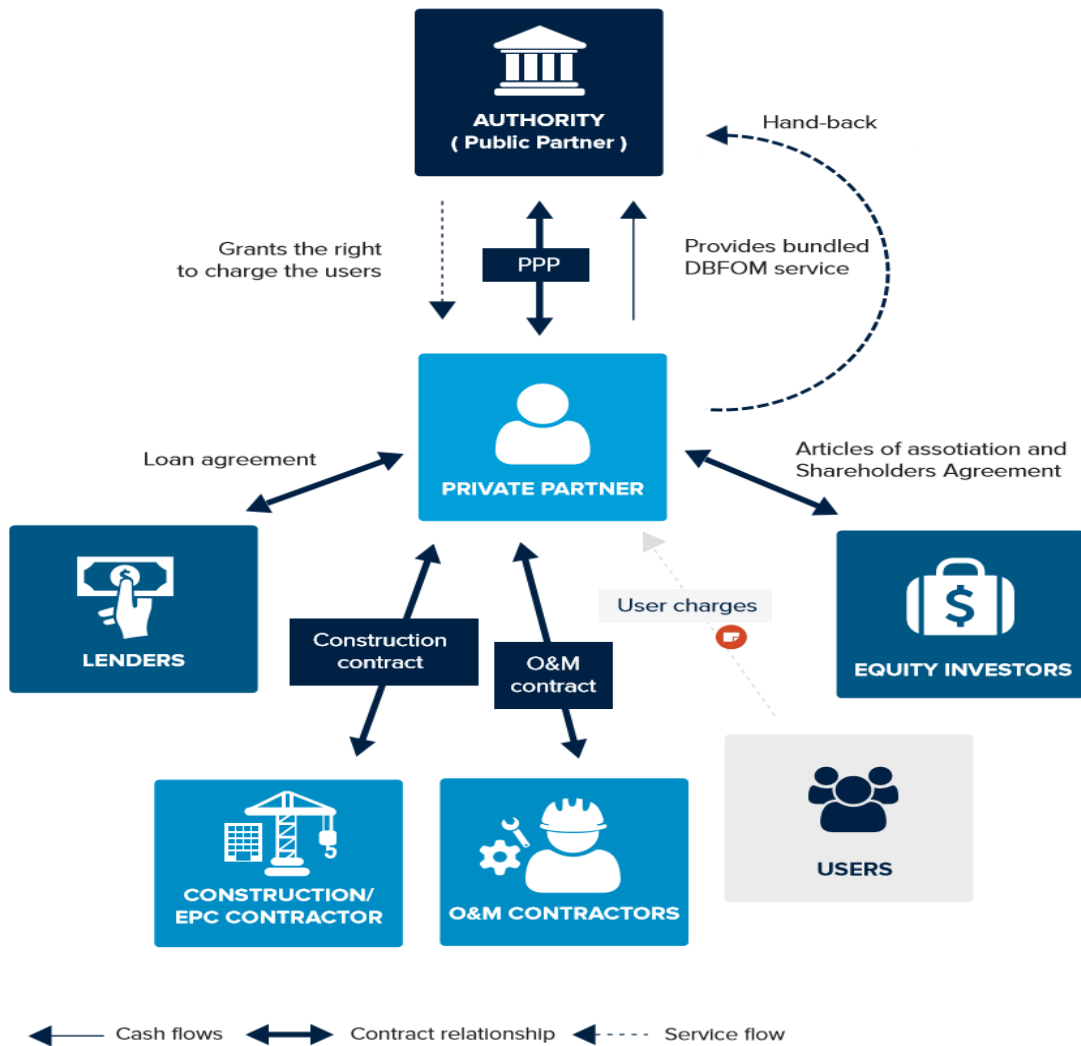

Figure 1. DBFOM Procedure

The fourth and last factor is the *Availability of Government legalization and policies that support PPP initiatives* as commonly there are typically two central legal systems, common law (when the framework is being developed under common law, it will take the form of policy statements or documents) and civil code jurisdiction (it is more likely to rely on the laws made by the government).

### 2.6.5 Design Related Factors

As the contractors' revenue is determined by performance, this provides an incentive

for them to develop innovative and cost-effective solutions with more creative ideas. If the public sector writes a tender focusing on performance, these efficiencies can be captured for public authority and taxpayers' benefits. The design-related factors are based upon and build, considering current asset information and assessment, targeted requirements, feasibility study and recommended options, implementation [documentation, design and sustainability, construction (transformation /repurposing), operation, maintenance and hand back]; accordingly, four factors are identified herein.

It starts with a *proper assessment of the environmental impact by project stakeholders* as the first factor where the environment becomes a way of life rather than just a luxury thing that might or might not be adapted to the project. It has proven to have numerous benefits over the project's life cycle, which require extra attention and consideration.

The second factor was *utilizing innovational design technology by project stakeholders (such as BIM- Building Information Modelling)*. The amount of information usually lost during the transactions between project stages (tender, construction, operation and handing over) can reach up to 15%. Utilizing innovation technology such as BIM as a common data environment can have numerous advantages in data centralizing and information sharing through the project life cycle, which is part of the project success communication plan and other aspects such as coordination and alike.

The third factor is *an effective design management plan* as PPP has the design phase embedded into the process, which will feed the construction. The principle behind that streamlines the process and shorten the project preparation and execution period ahead of operation; hence, a proper design management plan is essential to execute the project on time and within cost.

Finally, the *consideration of sustainability in design, including modularity, post-event*

*usage*, is the fourth factor as in some instances, and the facility might not generate the expected outcome in terms of revenue, which will add some pressure on the public party to repay its obligation to the private parties involved in the project financing and execution. One option to tackle this challenge is by repurposing the assets to generate different categories of the outcome, which can be seen in some cases like in Germany. The challenge that arises from this approach is the suitability of the assets to be repurposed, with the least cost (modularity), which is part of the design and construction sustainability; Hence, the paper considered this a critical factor.

#### 2.6.6 Construction-related Factors

Construction is one of the primary objectives for the private party to engage his assets and resources; hence, five factors had been identified, starting with an *Effective subcontractor selection procedure by the Project Company* as the first factor under this group where Subcontractors play a significant role in projects; hence, proper selection must ensure project success.

The second factor is a *Well-defined construction period* where the construction period must be realistic and achievable to meet the public sector demand within the private sector's capability. Otherwise, the PPP project is meant to fail before it starts.

The third factor is related to the investors mainly as a *Consistent and effective project performance monitoring* will be the only guidance for them to understand what is being accomplished and what issues need step-in arrangement to ensure the success of the project; accordingly, monitoring is crucial to identify any problems ahead and work toward proper solutions among all stakeholders, so all project stakeholders and shareholders are on the same page.



Safety is one critical item regardless of if the procurement option is PPP or traditional procurements. And accordingly, *an Effective safety management plan during the construction and operation phase* was selected as the fourth factor under this group.

Among each tender price, there is an absolute 'Cost of Quality.' In the PPP shape, quality takes more attention from the private sector as it is linked to the performance and the operation. Meaning to say that the private party will not be paid until the facility is operational. On top of that, there is a payment deduction mechanism associated with service delivery; Hence, *an Effective quality management plan during the construction and operation phase* was selected as the fifth factor since quality is an essential and critical factor.

#### *2.6.7 Operation related Factors*

Operation is also one of the primary objects for the private party as it involves engaging exiting FM resources and payment usually linked to achieving a pre-defined service level during this stage; Accordingly, five factors are identified, starting with *Effective management of operational problems during operation by the Project Company* as the first factor since payments are linked to service delivery, the operation problem's leadership is critical to avoid payment deduction associated with service delivery failure, and the FM contractor shall do this.

The second factor relates to the first factor, from a contractual perspective but the SPV point of view considering an *Effective change management system in the operational contract agreements by the stakeholders* given that also the payments to the private party (SPV) are linked to the facility performance, any changes during the operation stages must follow a streamlined process approach to avoid any services hindering. The third factor is the operation/finance related factor, as the *Well-defined operation*

*(concession) period* determine the amount of innovation required and the maintenance regime of significant project components.

The project timeline and planning approach along the project's life cycle involves many aspects such as operation and maintenance, payment scheme and finance charges. In some instance, the private party can offer the privilege to the public party by lesser concession period part of their original proposal, which gives more advantages in terms of earlier hand back and lesser finance fees. In any case, given the correct concession period, the private party can determine the best assets lifetime that can fit for purpose in terms of constructability and replacement cycle during the facility's lifetime and cater to any obsolescence issues in the future. The fourth factor is linked with *Long term demand for the project post-event*. This factor is related to the outcome expectation of the project.

Typically, in the social type of infrastructure, the government is responsible for the payments and not the end-users, contrary to the commercial kind. Finally, the *consideration of sustainability in operation while maintaining service levels* is considered the fifth factor as it will enable the private party to view a more innovative approach. In contrast, operating and maintaining the facility to seek any chance for value-enhancing considers the three sustainability pillars, economic growth, social change, and successful environmental conservation. These pillars should be regarded as in the project phases since that is when a project can be influenced most effectively and monitored throughout the project life cycle.

#### *2.6.8 Sports-related Factors*

Although this group was not considered in previous studies, three factors were identified based on lesson learnt from other implementations in some countries due to

the uniqueness of the subject.

The first factor is the *suitability of the size of the sports facility for usage after the event*, where the size of the sports facility (in our case, stadium) played a significant role in the success. For example, one of the successful World-cup stadia stories is Turner Field, designed for the 1996 Summer Olympics in Atlanta. Following the Olympics, the Atlanta Braves agreed to eliminate the running track, reduce the seating capacity, and transform Centennial Olympic Stadium, now Turner Field, into a baseball stadium. The stadium's adaptation to local sporting needs was evident, as it has hosted more than 80 baseball games every season over the past three seasons.

The second factor is the *adaptability for the conversion of the sports facility after the event*. Although this factor was not mentioned as a critical factor before, the conversion's adaptability can play a significant role for multi-purposing, resulting in additional income from different events under different categories. The Sapporo Dome, which hosted the 2002 FIFA World Cup finals, is an example of this. It has been able to host several activities due to its multi-functionality, roof, and retractable surface. The stadium hosted 118 events in 2010, with the bulk of them being sporting events.

The third factor is the *availability of other sports facilities with similar functions*. Other sports facilities' availability might impact the procured facility's feasibility study, resulting in no gain for both public and private parties.

## 2.7 Summary of the Critical Success Factors and Groups

Table 2 below summarise the factors and their references that resulted from the literature review.

A thorough examination has been carried out to identify the factors that are relevant to

the subject study summarized below:

Table 2. Summary of Critical Success Factors and References

<i>No.</i>	<i>Category</i>	<i>Factor</i>	<i>Reference</i>
1	Stakeholders	Clarity of roles and responsibilities among stakeholders	Abdul-Aziz et al. (2010), Tang et al. (2013), Jamali D (2011)
2	Stakeholders	Realistic sharing of income by stakeholders	Mladenovic et al. (2013), Partnerships UK (2006), Jacobson C. et al. (2008)
3	Stakeholders	Public/community support to the project	Li, B. et al. (2005), Zhang & AbouRisk (2006), Babatunda et al. (2015)
4	Stakeholders	Open and constant communication among stakeholders	Tang et al. (2012), Jacobson and Choi (2008), Hamilton (2015)
5	Stakeholders	Compatibility skills among stakeholders	Abdul-Aziz et al. (2010), Partnerships UK (2006), Chen et al. (2006)
6	Risk	Appropriate risk allocation and sharing among stakeholders	Ng & Wong (2006), Abd Karim (2011), Satpathy & Das (2007)
7	Risk	Timely securing of necessary access permits	Ng and Loose more (2007); Mezher and Tawil (1998), El-Sayegh (2008)
8	Risk	Timely access to the project site by Project Company	Fan et al. (1989); Mustafa and Al-Bahar (1991); Sun and Meng (2009)
9	Risk	Effective operational risk management during the construction and Operation Stage	Liu et al. Osei-Kyei (2015), Robinson and Scott (2009), Edward et al. (2004)
10	Finance	A competitive financial proposal by the Project Company	Dulaimi, M.F. et al. (2010), Askar et al. (2002), Tiong, R.L.K. (1996),
11	Finance	An effective payment mechanism to the Project Company during the operation stage	Abdulaziz (2007), Robinson and Scott (2009), Oyedele (2012)
12	Finance	Effective life cycle cost analysis for the project by the Project stakeholders	Li, B., Akintoye et al. (2005), Mladenovic, G. (2013), Jamali, D. (2004)
13	Finance	Government providing guarantees for the rate of return	Liu, T., Wilkinson, S. (2013), Ng, S.T. et al. (2012), Babatunde S. O. et al. (2012),
14	Finance	Stable macroeconomic condition	Babatunde S. O. et al. (2012), Chan et al. (2010), Li et al. (2005a), Zhang (2005)
15	Legal	Well-structured legal framework during construction and operation stages	Robinson and Scott (2009); Javed et al. (2013); Jamali (2004), Hwang et al. (2013)
16	Legal	Well written contract document protecting all project stakeholders	Jefferies, M. (2006), Li, B., et al. (2005), Hwang et al. (2013)
17	Legal	Well defined bidding process for the project	Mahalingam (2010), Chen et al. (2006), Javed et al. (2013)

<i>No.</i>	<i>Category</i>	<i>Factor</i>	<i>Reference</i>
18	Legal	Availability of Government legalization and policies that support PPP initiatives	Babatunde et al. (2015), Abdul-Aziz et al. (2010), Hwang et al. (2013)
19	Design	Proper assessment of the environmental impact by project stakeholders	Tiong, R.L.K. (1996), Jefferies et al. (2002), Ng S.T. et al. (2012)
20	Design	Utilization of innovational design technology by project stakeholders (such as BIM- Building Information Modelling)	Corbett & Smith (2006), Bossink (2004), Ng S.T. et al. (2012)
21	Design	An effective design management plan	Tang, L. et al. (2013), Raisbeck, P., Tang L.C.M. (2013), Jefferies, M. (2006)
22	Design	Consideration of sustainability in design, including modularity, post-event usage	Tiong, R.L.K. (1996), Jefferies et al. (2002), Ng et al. (2012)
23	Construction	Effective subcontractor selection procedure by the Project Company	Errasti et al., (2007), Zhang, X. (2005a), Jefferies, M., et al. (2002)
24	Construction	Well defined construction period	Ozdoganm, I.D. et al. (2000), Chan, P.C. et al. (2010), Jacobson C., Choi, S.O. (2008)
25	Construction	Consistent and effective project performance monitoring	Edwards et al. (2004), Partnerships UK (2006), Meng, X. et al. (2011)
26	Construction	Effective safety management plan during construction and operation phase	Liu et al. (2014), Fung et al. (2010), Carter & Smith (2006)
27	Construction	Effective quality management plan during construction and operation phase	Dixon et al. (2005), Meng et al. (2011), Ng et al. (2012)
28	Operation	Effective management of operational problems during operation by the Project Company	Partnerships UK (2006), Robinson and Scott (2009), Ng et al. (2012)
29	Operation	Effective change management system in the operational contract agreements by the stakeholders	Edwards et al. (2004), Partnerships UK (2006), Hwang, B. et al. (2013)
30	Operation	Well defined operation (concession) period	Ozdoganm, I.D. et al. (2000), Chan, P.C. et al. (2010), Jacobson C., Choi, S.O. (2008)
31	Operation	Long term demand for the project post-event	Meladenovic et al. (2013), Ozdoganm and Birgonul (2000), Chan, P.C. et al. (2010),
32	Operation	Consideration of sustainability in operation while maintaining service levels	Tiong, R.L.K. (1996), Jefferies et al. (2002), Jefferies (2006)
33	Sports	Suitability of the size of the sports facility for usage after the event	Not Applicable

<i>No.</i>	<i>Category</i>	<i>Factor</i>	<i>Reference</i>
34	Sports	Adaptability for the conversion of the sports facility after the event	Not Applicable
35	Sports	Availability of other sports facilities with similar functions	Not Applicable

Again, it is worth mentioning that these factors are applicable not only to sports infrastructure assets but to any other assets intended to be procured under the PPP module.

## CHAPTER 3: RESEARCH METHODOLOGY

### 3.1 Introduction

In this section, the research will elaborate more on the study's design approach and how it intends to be completed and analyzed.

### 3.2 The Research Question

The research problem statement was defined in chapter one and further elaborated in chapter two; The question which the study is aiming to receive an answer for is:

What is the impact or importance of the following factors on "Implementation of Public-Private Partnership (PPP) in Sports Infrastructure transformation Post-event (Legacy)"?

There were 35 factors identified under eight different groups that were targeted to be discussed in the study, as shown in the below table:

Table 3. Identified Critical Success Groups and Factors

No.	Group	Factor
1	Stakeholders	Clarity of roles and responsibilities among stakeholders
2	Stakeholders	Realistic sharing of income by stakeholders
3	Stakeholders	Public/community support to the project
4	Stakeholders	Open and constant communication among stakeholders
5	Stakeholders	Compatibility skills among stakeholders
6	Risk	Appropriate risk allocation and sharing among stakeholders
7	Risk	Timely securing of necessary access permits
8	Risk	Timely access to the project site by Project Company
9	Risk	Effective operational risk management during the construction and Operation Stage operation stage
10	Finance	A competitive financial proposal by the Project Company

<b>No.</b>	<b>Group</b>	<b>Factor</b>
11	Finance	An effective payment mechanism to the Project Company during the operation stage
12	Finance	Effective life cycle cost analysis for the project by the Project stakeholders
13	Finance	Government providing guarantees for the rate of return
14	Finance	Stable macroeconomic condition
15	Legal	Well-structured legal framework during construction and operation stages
16	Legal	Well written contract document protecting all project stakeholders
17	Legal	Well defined bidding process for the project
18	Legal	Availability of Government legalization and policies that support PPP initiatives
19	Design	Proper assessment of the environmental impact by project stakeholders
20	Design	Utilization of innovational design technology by project stakeholders (such as BIM-Building Information Modelling)
21	Design	An effective design management plan
22	Design	Consideration of sustainability in design, including modularity, post-event usage
23	Construction	Effective subcontractor selection procedure by the Project Company
24	Construction	Well defined construction period
25	Construction	Consistent and effective project performance monitoring
26	Construction	Effective safety management plan during construction and operation phase
27	Construction	Effective quality management plan during construction and operation phase
28	Operation	Effective management of operational problems during operation by the Project Company
29	Operation	Effective change management system in the operational contract agreements by the stakeholders
30	Operation	Well defined operation (concession) period
31	Operation	Long term demand for the project post-event
32	Operation	Consideration of sustainability in operation while maintaining service levels
33	Sports	Suitability of the size of the sports facility for usage after the event
34	Sports	Adaptability for the conversion of the sports facility after the event
35	Sports	Availability of other sports facilities with similar functions



### 3.3 The Research Approach/Strategy

#### *3.3.1 The Research Method*

The research method part of this study will undergo five consecutive phases, as described below:

##### **Phase 1. Identification Phase:**

This phase is meant to identify the research problem and the gaps related to implementing PPP in Sports infrastructure that must be understood and analyzed.

##### **Phase 2. Literature review Phase:**

This phase meant understanding previous studies and research related to the problem statement resulting from the identification phase. In this phase, the researcher will identify the factors that contribute the most to the problem statement.

##### **Phase 3. Peer Review Phase:**

The critical success factors will be peer review by professionals in the academic and professional fields for their advice.

##### **Phase 4. Data collection Phase:**

In this phase, the factors shortlisted in the literature review phase will reshape into a questionnaire to collect the data analyzed at the next phase.

##### **Phase 5. Analysis Phase:**

In this phase, the data will be tested for and screened for non-completed data and outliers.

The phase will also include the building of the original model, modified model and final SEM model. The models will be assessed for reliability, validity and normality and make any adjustments accordingly.

There will be two main models, one related to the group's critical success factors and one related to the individual critical success factors, which be used later to examine the results. A relative importance index will also be used for ranking the data for exploring purposes.

**Phase 6. Recommendation and Conclusion Phase:**

This phase will include the conclusion and recommendations based on the research and data analysis resulted in the previous phase.

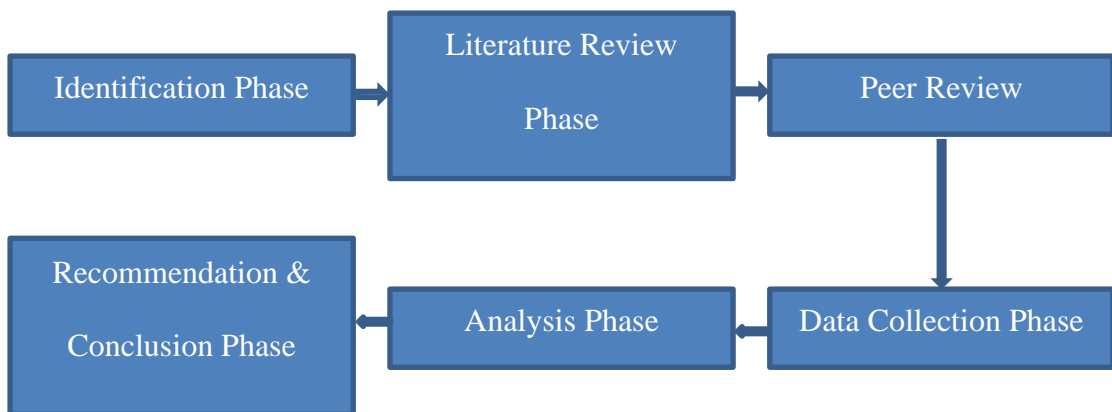

Figure 2. Research Methodology

*3.3.2 Data Collection model*

The study results were obtained through an online survey published globally using the Survey Monkey platform in the month of December 2020 up to January 2021.

*3.3.3 The Research Design Process*

A qualitative approach is considered in this study. Appendix B contains the questionnaire selected for the factors identified in Appendix A and the literature review.

The survey has three parts, as follows:

- 1- General Questions
- 2- Individual critical success factors
- 3- Groups critical success factors

The general questions contained six questions related to the respondent profiles and background, among other factors. The individual Critical success factors questions have a rating scale from low important to extremely important on five levels for 35 factors falling under eight headings. The last part of the survey focuses on the groups' critical success factors, where also a rating scale from low important to extremely important on five levels but for the eight groups.

The participants were requested to evaluate the importance of each factor and group.

Table 4. Response sample and scaling

Not Important	Low important	Moderate Important	High Important	Extremely Important
1	2	3	4	5

### 3.4 Response Strategy and Scaling

The collected responses are varying from low important up to extremely important. This was later changed to a scale of 1 to 5 to enable the analysis to run smoothly, as further explained in chapter 4, Data analysis.

### 3.5 Sample size

The targeted responses were 150 to 200. The survey has achieved a total of 275 responses, where 214 were the complete responses that were used to undertake the analysis.

Previous studies on Structural Equation Modelling indicated that a sample size between 100 to 150 are adequate to represent the community. However, bootstrap will also be done to elaborate more exponentially a bigger sample size and give more confidence to the results.

The SEM's recommended sample sizes range from 100 to 200 for a reliable result analysis (Molwus et al., 2013). Accordingly, the 168 responses that remain after removing the unsuitable data is sufficient for SEM analysis.

### 3.6 Catering for partial responses and Non-Serious Responses (outliers)

A thorough examination will be completed to identify any non-serious responses using the AMOS SPSS, which will be explained later in the SEM analysis.

### 3.7 Research Hypothesis

The 35 factors identified as success factors have been grouped into eight categories intended to be tested against their impact on the implementation PPP framework for Sports infrastructure as follows:

- 1- Stakeholders have a massive influence on the implementation PPP framework for Sports infrastructure.
- 2- Project Risks register has a massive impact on the implementation PPP framework for Sports infrastructure.
- 3- Legal structure plays have a leading impact on the implementation PPP framework for Sports infrastructure.
- 4- Finance for both private and public plays a significant role in implementing.
- 5- Design and innovation play a major role in the project life cycle.
- 6- Construction factors considered a significant and leading factor in the

implementation PPP framework for Sports infrastructure.

7- Operation factors also considered a significant and leading factor in the implementation PPP framework for Sports infrastructure.

8- Sports-related factors have the least impact on the implementation PPP framework for Sports infrastructure.

## CHAPTER 4: DATA ANALYSIS

### 4.1 Introduction

This chapter will discuss the Data Analysis resulting from the Critical Success Factors survey as the survey questionnaire is the primary tool for obtaining the information and data. However, these data were treated carefully and modified to enable a realistic model that fits the purpose to be established (such as screening for outliers and treatment accordingly). The survey contained three parts (General, Individual Critical Success Factors, and Critical Success Factors Group). The analysis will be done as follows:

- 1- Descriptive Analysis - Respondent's profiles
- 2- Descriptive Analysis – Original Data
  - a. individual Critical Success Factors
  - b. Critical Success Factors Groups
- 3- Relative Importance Index (RII) – Original Data
- 4- Data Screening and outlier's treatment
- 5- Descriptive Analysis – Modified Data
  - a. individual Critical Success Factors
  - b. Critical Success Factors Groups
- 6- Relative Importance Index (RII) – Modified Data
- 7- Structural Equation Modelling – Modified Data
  - a. Measured Model
  - b. Modified Model
  - c. The full Structural Model

The description of each step above will be included in the relevant section.

## 4.2 Descriptive Analysis - Respondent's profiles

This section will highlight and analyze the survey's general part representing the respondents' profile, such as their organization, background, years of experience, and alike. The analysis is descriptive for the respondent's profile.

Although 275 responses were received for the general part (survey part one), only 214 completed the entire survey. Accordingly, this section analysis will only analyze the completed survey responses (214) and not partial responses.

The general part contained six questions to identify the respondent profile and background, highlighting respondents' organization, knowledge, experience, and other skills. The questions and the analysis of their responses are as explained hereinafter:

Question 1: Which Organization can represent your major experience?

Table 5 below indicates that out of 214 respondents, 135 responses came from the Private Sector, which represents 63.08%; 51 answers came from the Public Sector, which represents 23.83%; 27 answers came from semi-government entities representing 12.62%, and lastly, one response came from Non-profit Organization under others. This indicates diversities in opinions that will benefit the study as the subject has massive interaction with different entities.

Table 5. Respondents Organizations Categories

Answer Choices	Responses	
Public Sector	23.83%	51
Private Sector	63.08%	135
Semi-Government	12.62%	27
Other (please specify)	0.47%	1

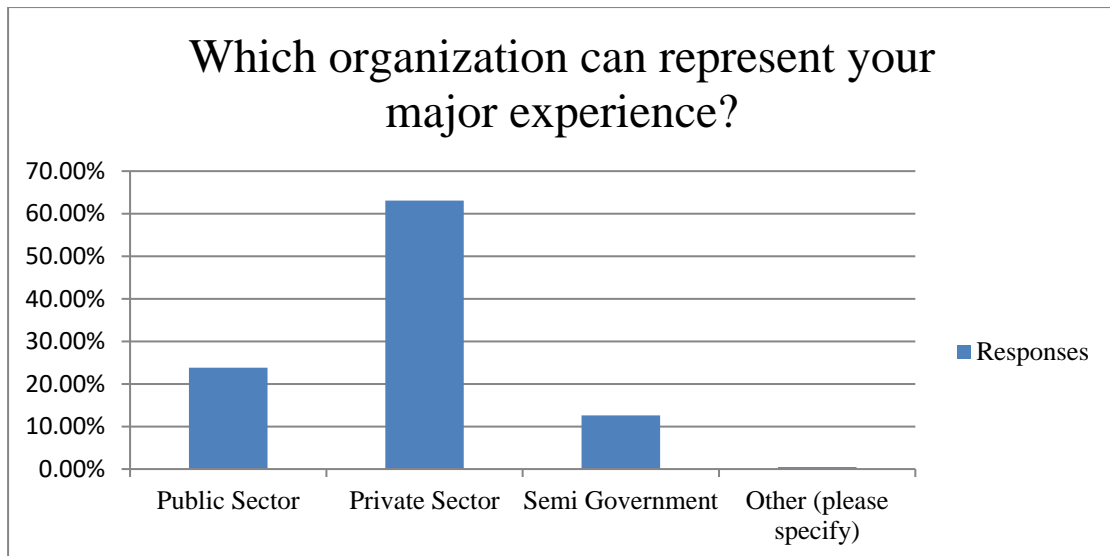

Figure 3. Respondents Organizations Categories

Question 2: What sector/organization can represent your major experience?

Table 6 below indicates that out of 214 respondents, 68 responses came from contractor's dire which represents 31.78%; 47 answers came from Project Manager/Construction Manager which means 21.96%; 34 answers came from Employer/Client entities representing 15.89%, and the remaining responses were representing different sectors as shown below. The response illustrates different sectors opinions which enhance the credibility of the subject study.

Table 6. Respondents Sector Experience

Answer Choices	Percentage	Responses
Employer/Client	15.89%	34
Contractor	31.78%	68
Consultant	13.55%	29
Designer	2.34%	5
Project Manager/Construction Manager	21.96%	47
Facility Management/Operation	3.27%	7
Finance/Banking	0.47%	1
Developer	0.93%	2
Legal Affairs	0.93%	2
Universities (Research and development)	3.27%	7
Other (please specify)	5.61%	12





Figure 4. Respondents Sector Experience

Question 3: What is your current rule in your current company?

Table 7 below indicates that out of 214 respondents, 89 responses represent the majority came from Department Head/Senior Manager who represents 41.59%; 64 answers came from Mid Senior level representing 29.92%; 23 answers came from Executive Managers level (CEO, CFO, COO, CO) which means 10.75% and the remaining responses were distributed between standard level and others such as researchers as shown below.

The response illustrates the different variety in rules among respondent, and a good number of responses were received from experience people that will enhance the resulted value of the study.

Table 7. Respondents Rules

Answer Choices	Responses	
Executive Manager (CEO, CFO, COO, CO)	10.75%	23
Department Head/Senior Manager	41.59%	89
Mid Senior Manager	29.91%	64
Standard Level	15.89%	34
Other (please specify)	1.87%	4

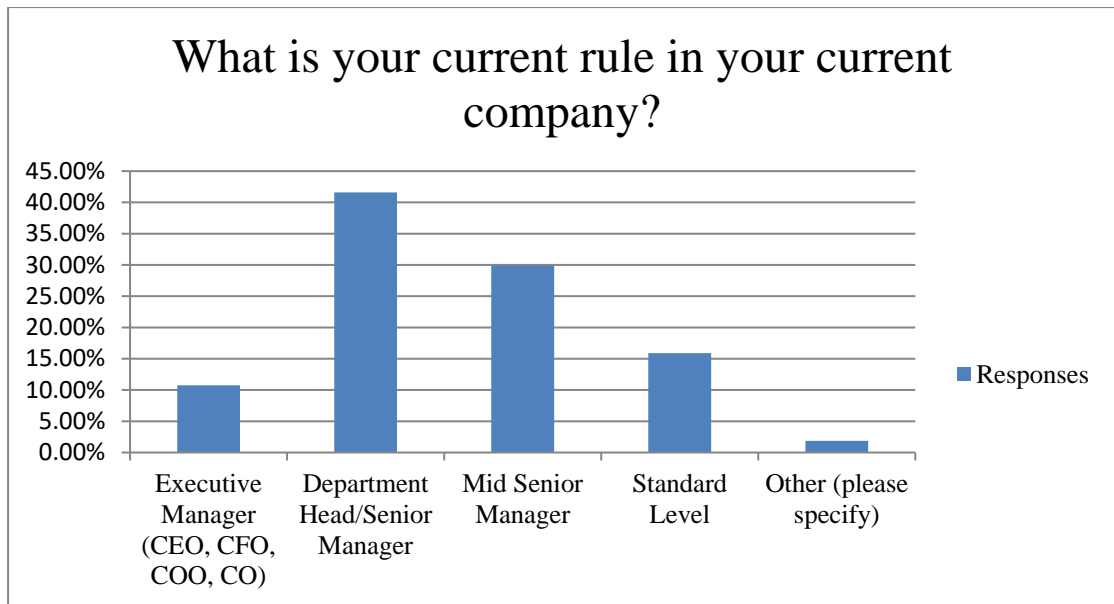

Figure 5. Respondents Rules

Question 4: What is your area(s) of expertise?

Table 8 below indicates that out of 214 respondents, 129 responses came from expertise in the project construction management field, which represents 60.28%; 66 answers came from Design and Engineering expertise representing 30.84%; other expertise responses included Legal Management, Facility Management and Finance, Account Management where their responses were distributed as shown below.

Table 8. Respondents Area(s) of Expertise

Answer Choices	Responses	Percentage
Project Construction Management	129	60.28%
Design and Engineering	66	30.84%
Innovation (Research and development)	14	6.54%
Facility/Operation management	26	12.15%
Legal Management	7	3.27%
Commercial and Contracts	44	20.56%
Controlling and Risk Management	18	8.41%
Tendering and estimation	36	16.82%
Real-estate and development	10	4.67%
Assets Management	11	5.14%
Finance/account management	7	3.27%
Other (please specify)	17	7.94%

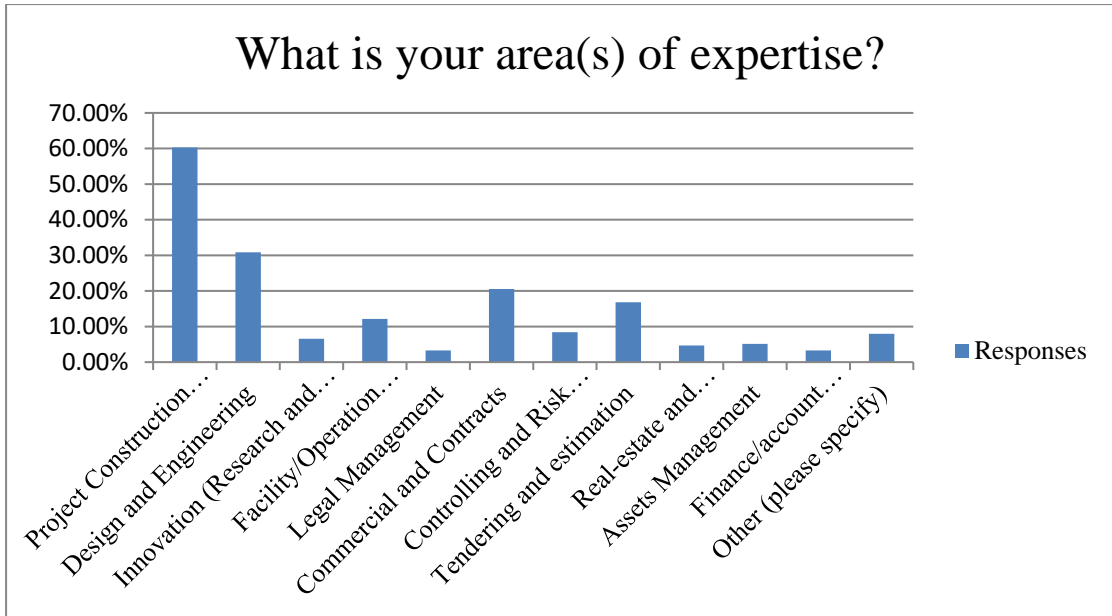

Figure 6. Respondents Area(s) of Expertise

Question 5: Which type of projects you are familiar with and reflect your experience?

The responses indicated a variety of background among the respondents, as shown below.

Table 9. Respondents Type of Projects Experiences

Answer Choices	Responses	
Building Constructions	61.68%	132
Infrastructure (Road, Bridges, Railway...etc.)	47.66%	102
Utilities (Water, Electricity, Drainage, Telecom)	32.71%	70
Oil and Gas	18.22%	39
Sports Facilities	16.36%	35
Urban Planning and Transportation	8.41%	18
Theme Parks and museums	5.61%	12
Information technology (IT)	6.54%	14
Other (please specify)	8.41%	18

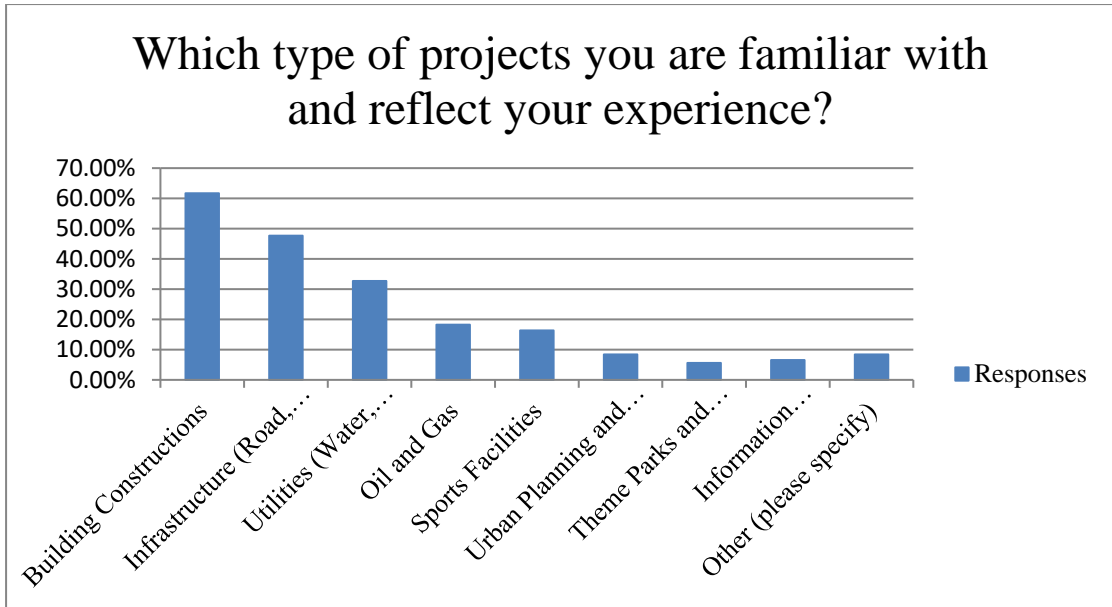

Figure 7. Respondents Type of Projects Experiences

Question 6: What is your total number of years of working experience?

Table 10 shows the years of experience among the respondents, which indicates the seniority of them.

Table 10. Respondents total number of years of working experience

Answer Choices	Responses	
Less than or equal to 5 years	9.35%	20
(6-10) years	11.68%	25
(11-15) years	30.37%	65
(16-20) years	18.22%	39
(21-25) years	11.21%	24
More than 25 years	19.16%	41

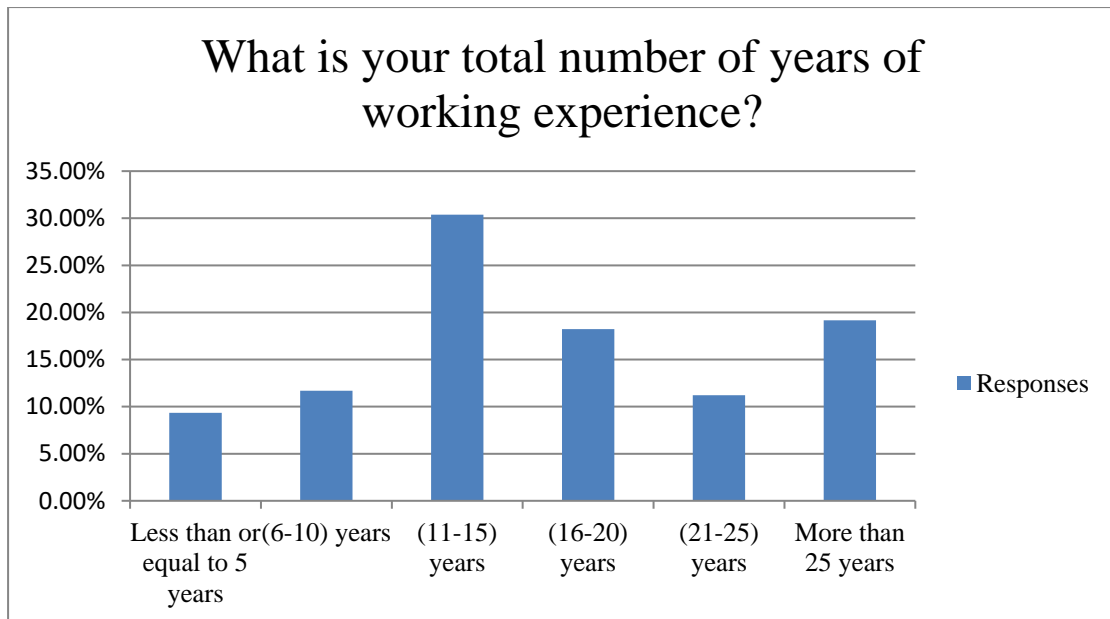

Figure 8. Respondents total number of years of working experience

In conclusion, the respondents' profiles show seniority level responses from different fields and areas of expertise, positively impacting the result.

#### 4.3 Descriptive Analysis – Original Data

This section will discuss the original data obtained from the survey without data treatment for individual critical success factors and critical success factors groups.

##### *4.3.1 Individual Critical Success Factors*

This section will highlight and analyze the individual Critical Success Factors among their groups as part of the survey representing the respondents' thoughts in terms of importance.

Two hundred fourteen completed the entire survey will be discussed and analyzed from now on. This part contains eight questions for thirty-five factors. The factors are coded, as shown below:

Table 11. Critical Success Factors groups and items coding

No.	Factor	code
<b>Stakeholders Factors Group</b>		
1	Clarity of roles and responsibilities among stakeholders	ST_1
2	Realistic sharing of income by stakeholders	ST_2
3	Public/community support to the project	ST_3
4	Open and constant communication among stakeholders	ST_4
5	Compatibility skills among stakeholders	ST_5
<b>Risk Factors Group</b>		
6	Appropriate risk allocation and sharing among stakeholders	R_1
7	Timely securing of necessary access permits	R_2
8	Timely access to the project site by Project Company	R_3
9	Effective operational risk management during the construction and operation stage	R_4
<b>Finance Factors Group</b>		
10	A competitive financial proposal by the Project Company	F_1
11	An effective payment mechanism to the Project Company during the operation stage	F_2
12	An effective life cycle cost analysis for the project by the project stakeholders	F_3
13	Government providing guarantees for the rate of return	F_4
14	Stable macroeconomic condition	F_5
<b>Legal Factors Group</b>		
15	Well-structured legal framework during construction and operation stages	L_1
16	Well written contract document protecting all project stakeholders	L_2
17	Well defined bidding process for the project	L_3
18	Availability of Government legislation and policies that support PPP initiatives	L_4
<b>Design Factors Group</b>		
19	Proper assessment of the environmental impact of the project	D_1
20	Utilization of innovation design technology (such as BIM- Building Information Modelling)	D_2
21	An effective design management plan	D_3
22	Consideration of sustainability in design, including modularity, post-event usage	D_4
<b>Construction Factors Group</b>		
23	Effective subcontractor selection procedure by the Project Company	C_1
24	Well defined construction period	C_2
25	Consistent and effective project performance monitoring	C_3
26	Effective safety management plan during construction and operation phase	C_4
27	Effective quality management plan during construction and operation phase	C_5
<b>Operation Factors Group</b>		
28	Effective management of operational problems during operation by the Project Company	O_1
29	Effective change management system in the operational contract agreements by the stakeholders	O_2
30	Well defined operation (concession) period	O_3
31	Long term demand for the project post-event	O_4
32	Consideration of sustainability in operation while maintaining service levels	O_5
<b>Sports Factors Group</b>		
33	Suitability of the size of the sports facility for usage after the event	S_1
34	Adaptability for the conversion of the sports facility after the event	S_2
35	Availability of other sports facilities with similar functions	S_3

The responses were categorized and classified based on their importance, as shown below in Table 12. The answers were translated from item code to number code so that the Amos software can recognize them while performing the analysis.

Table 12. Response Criteria and coding

Item	Code	Numb Code
Not Important	NI	1
Low Important	LI	2
Moderate Important	MI	3
High Important	HI	4
Extremely Important	EI	5

The next eight Tables and Figures will show the respondents interpretation and classifications of the individual critical success factors as below:

*Stakeholders Factors Group*

Five critical success factors were listed under this group, and the responses were as follows:

Table 13. Stakeholder Group Factor responses – Original Data

Code/ Response	NI	LI	MI	HI	EI
ST_1	0.93% 2	1.40% 3	15.89% 34	48.13% 103	33.64% 72
ST_2	1.87% 4	7.01% 15	27.10% 58	44.39% 95	19.63% 42
ST_3	0.47% 1	6.07% 13	28.04% 60	47.66% 102	17.76% 38
ST_4	0.47% 1	0.93% 2	15.42% 33	46.26% 99	36.92% 79
ST_5	0.93% 2	9.81% 21	31.78% 68	42.06% 90	15.42% 33

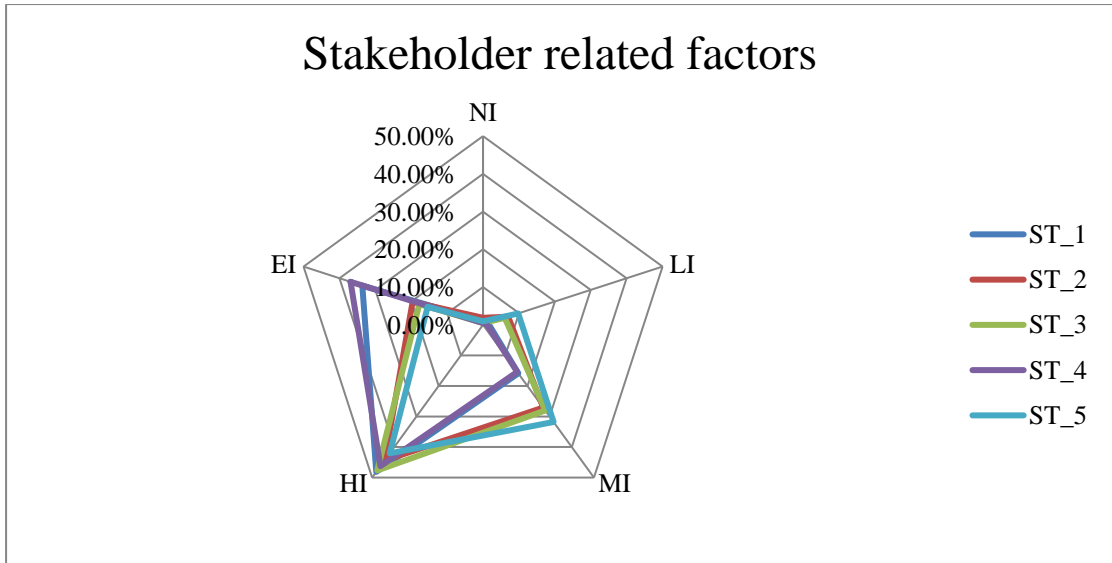

Figure 9. Stakeholder Group Factor responses – Original Data

The results indicate that all the factors fall under the High Importance Category with ranges of 103 response (48.13%) up to 90 responses (42.06%) out of the 214 completed responses received in the survey.

#### *Risk Factors Group*

Four critical success factors were listed under this group, and the responses were as follows:

Table 14. Risk Group Factor responses – Original Data

Code/ Response	NI	LI	MI	HI	EI
R_1	0.93% 2	3.27% 7	21.96% 47	51.40% 110	22.43% 48
R_2	0.47% 1	4.21% 9	26.64% 57	42.52% 91	26.17% 56
R_3	0.47% 1	3.74% 8	15.89% 34	47.66% 102	32.24% 69
R_4	0.93% 2	1.87% 4	20.09% 43	45.79% 98	31.31% 67



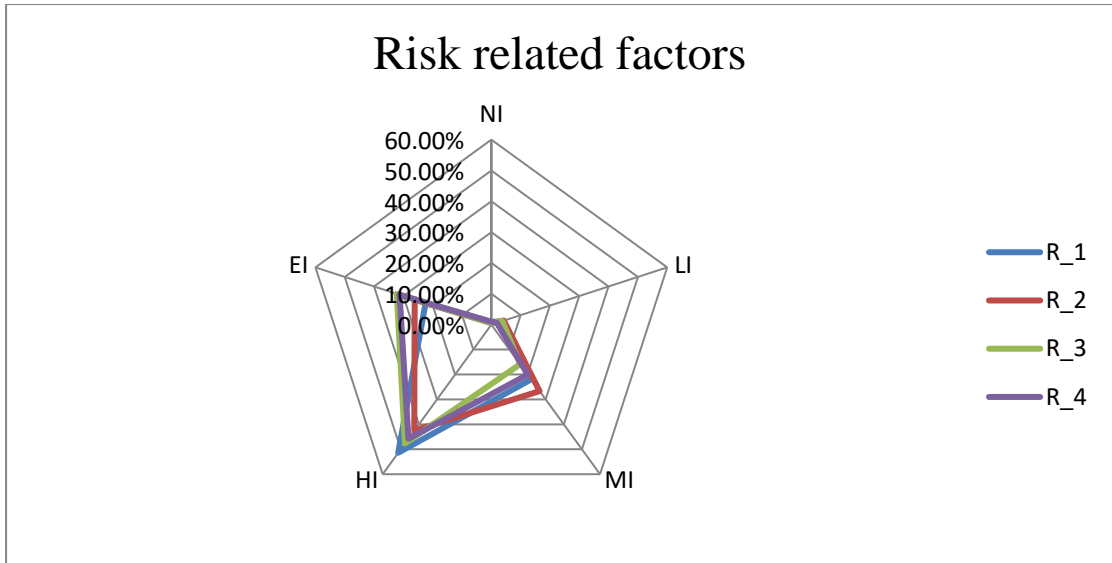

Figure 10. Risk Group Factor responses – Original Data

The results indicate that all the factors fall under the High Importance Category with ranges of 110 response (51.40%) up to 91 responses (42.52%) out of the 214 completed responses received in the survey.

*Finance Factors Group*

Five critical success factors were listed under this group, and the responses were as follows:

Table 15. Finance Group Factor responses – Original Data

Code/ Response	NI	LI	MI	HI	EI					
F_1	0.47%	1	2.34%	5	19.16%	41	48.13%	103	29.91%	64
F_2	1.40%	3	1.87%	4	14.02%	30	49.07%	105	33.64%	72
F_3	0.47%	1	2.80%	6	19.63%	42	52.34%	112	24.77%	53
F_4	2.80%	6	3.74%	8	25.70%	55	41.12%	88	26.64%	57
F_5	0.93%	2	3.27%	7	35.05%	75	42.99%	92	17.76%	38

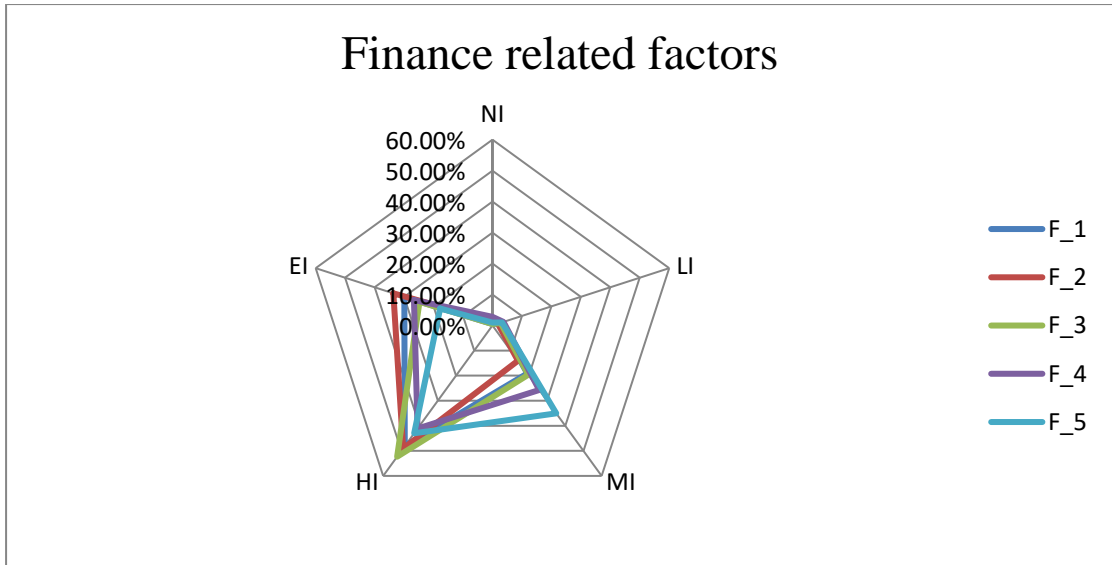

Figure 11. Finance Group Factor responses – Original Data

The results indicate that all the factors fall under the High Importance Category with ranges of 112 response (52.34%) up to 88 responses (41.12%) out of the 214 completed responses received in the survey.

*Legal Factors Group*

Four critical success factors were listed under this group, and the responses were as follows:

Table 16. Legal Group Factor responses – Original Data

Code/ Response	NI		LI		MI		HI		EI	
L_1	0.93%	2	1.87%	4	20.56%	44	46.73%	100	29.91%	64
L_2	0.47%	1	1.40%	3	9.35%	20	38.32%	82	50.47%	108
L_3	0.47%	1	0.93%	2	19.63%	42	43.46%	93	35.51%	76
L_4	0.47%	1	3.27%	7	21.50%	46	47.20%	101	27.57%	59

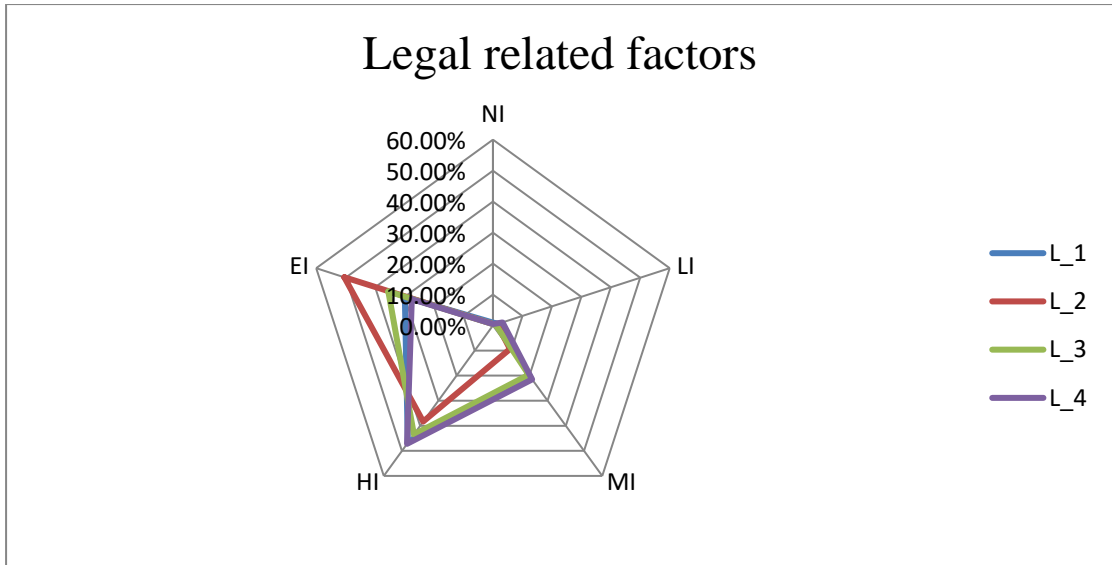

Figure 12. Legal Group Factor responses – Original Data

The results indicate that all the factors fall under the High Importance Category with ranges of 101 response (47.20%) up to 93 responses (38.32%) except for one factor that was categorized under extremely important with 82 responses (50.47%) which is the only case reported in the survey out of the 214 completed responses received in the survey.

### *Design Factors Group*

Four critical success factors were listed under this group, and the responses were as follows:

Table 17. Design Group Factor responses – Original Data

Code/ Response	NI	LI	MI	HI	EI					
D_1	0.47%	1	3.27%	7	30.37%	65	42.52%	91	23.36%	50
D_2	0.93%	2	7.48%	16	29.91%	64	42.52%	91	19.16%	41
D_3	0.00%	0	4.21%	9	20.56%	44	46.73%	100	28.50%	61
D_4	0.47%	1	3.27%	7	30.37%	65	44.39%	95	21.50%	46

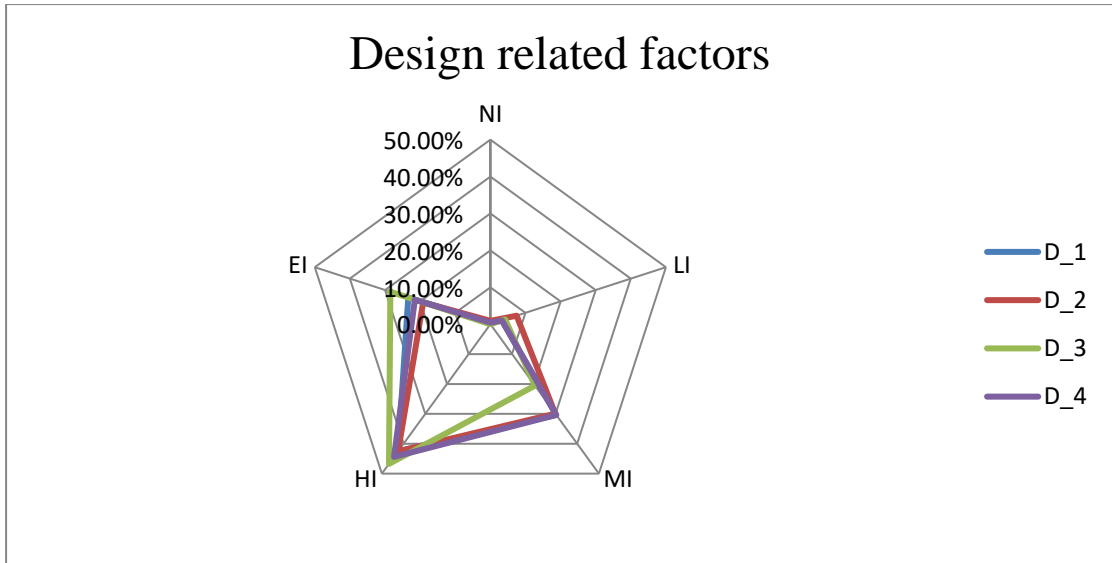

Figure 13. Design Group Factor responses – Original Data

The results indicate that all the factors fall under the High Importance Category with ranges of 100 response (46.73%) up to 91 responses (42.52%) out of the 214 completed responses received in the survey.

*Construction Factors Group*

Five critical success factors were listed under this group, and the responses were as follows:

Table 18. Construction Group Factor responses – Original Data

Code/ Response	NI	LI	MI	HI	EI
C_1	0.93% 2	3.27% 7	16.36% 35	53.27% 114	26.17% 56
C_2	0.47% 1	2.80% 6	21.50% 46	50.47% 108	24.77% 53
C_3	0.47% 1	2.34% 5	14.49% 31	58.41% 125	24.30% 52
C_4	0.47% 1	1.87% 4	19.63% 42	45.33% 97	32.71% 70
C_5	0.93% 2	3.74% 8	14.49% 31	52.80% 113	28.04% 60

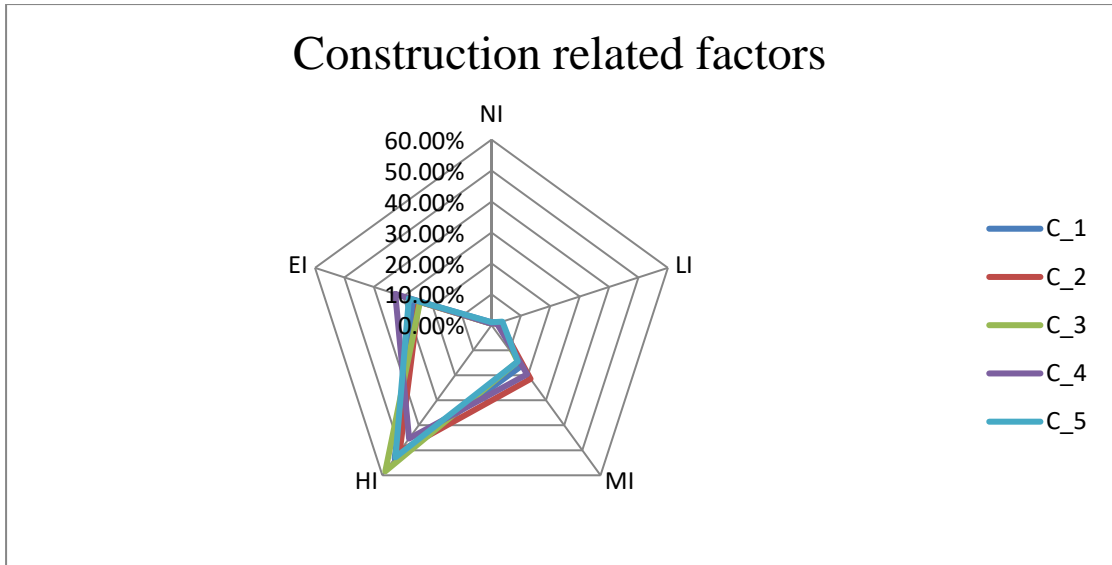

Figure 14. Construction Group Factor responses – Original Data

The results indicate that all the factors fall under the High Importance Category with ranges of 125 response (58.41%) up to 97 responses (45.33%) out of the 214 completed responses received in the survey.

*Operation Factors Group*

Five critical success factors were listed under this group, and the responses were as follows:

Table 19. Operation Group Factor responses – Original Data

Code/ Response	NI	LI	MI	HI	EI
O_1	0.00% 0	0.93% 2	18.22% 39	56.07% 120	24.77% 53
O_2	0.00% 0	5.14% 11	21.96% 47	51.40% 110	21.50% 46
O_3	0.47% 1	2.80% 6	21.50% 46	53.74% 115	21.50% 46
O_4	0.47% 1	3.74% 8	29.91% 64	45.79% 98	20.09% 43
O_5	0.47% 1	3.76% 8	27.70% 59	53.27% 114	15.02% 32

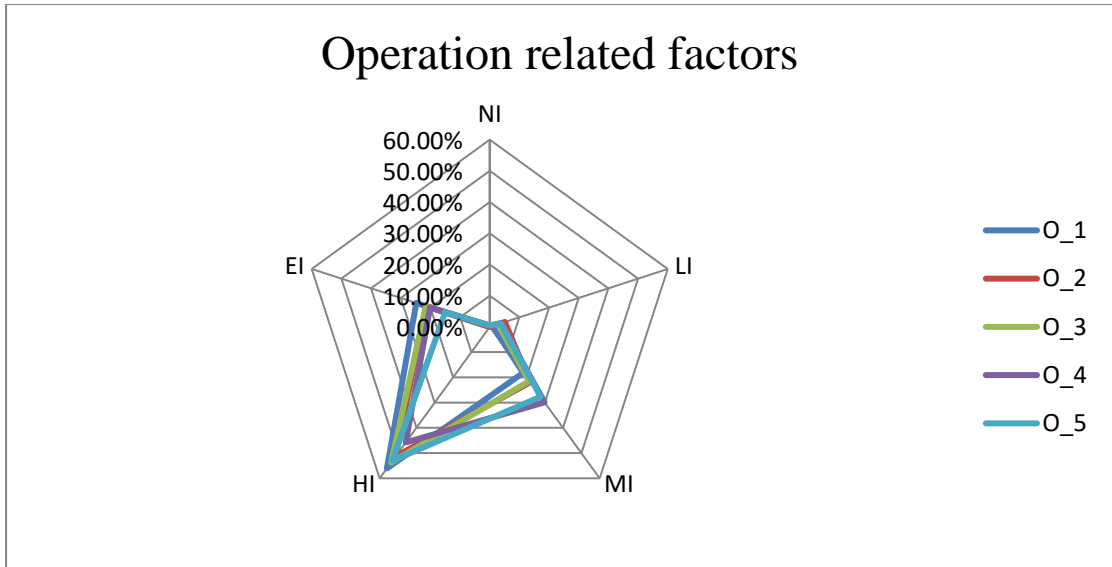

Figure 15. Operation Group Factor responses – Original Data

The results indicate that all the factors fall under the High Importance Category with ranges of 120 response (56.07%) up to 98 responses (45.79%) out of the 214 completed responses received in the survey.

*Sports Factors Group*

Three critical success factors were listed under this group, and the responses were as follows:

Table 20. Sports Group Factor responses – Original Data

Code/ Response	NI	LI	MI	HI	EI
S_1	1.40% 3	4.21% 9	27.57% 59	45.33% 97	21.50% 46
S_2	0.93% 2	6.07% 13	27.10% 58	48.13% 103	17.76% 38
S_3	4.21% 9	8.88% 19	36.92% 79	41.59% 89	8.41% 18

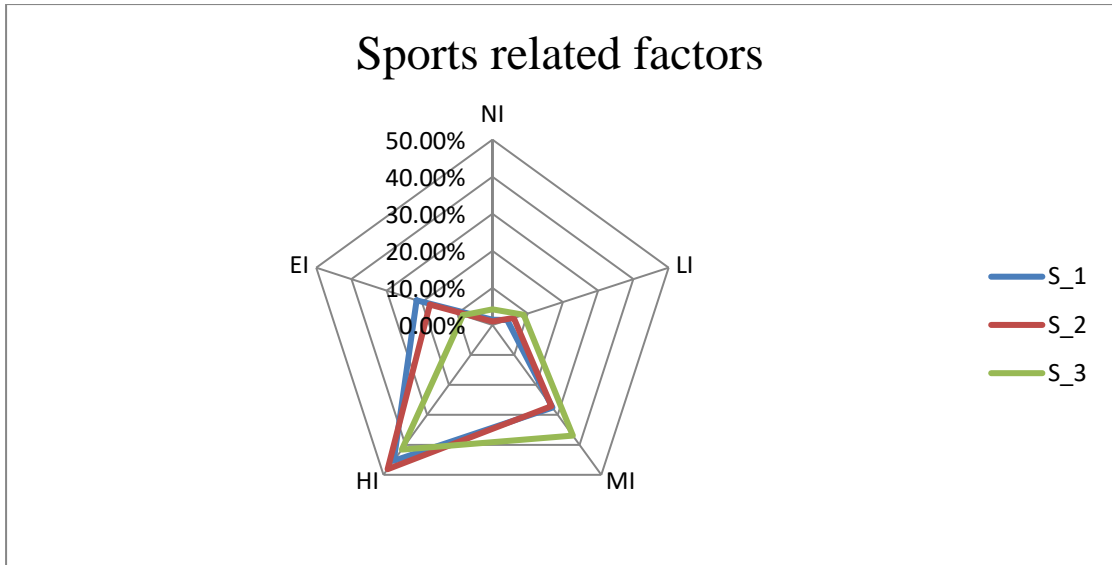

Figure 16. Sports Group Factor responses – Original Data

The results indicate that all the factors fall under the High Importance Category with ranges of 103 response (48.13%) up to 89 responses (41.59%) out of the 214 completed responses received in the survey.

*Summary of all Data – Original Data*

In the first observation, we can see that most of the responses indicated that all the factors are High Importance with ranges varying from 88 response (41.12%) up to 125 answers (58.41%) except for one factor that falls under the legal category (Well written contract document protecting all project stakeholders) which considered as per the response Extremely Important with 108 answers (50.47%) confirming the same.

Table 21. Summary of the highest responses on the Critical Factors – Original Data

No	Factor	Response	No	%
<b>Stakeholders Factors Group</b>				
1	Clarity of roles and responsibilities among stakeholders	HI	103	48.13%
2	Realistic sharing of income by stakeholders	HI	95	44.39%
3	Public/community support to the project	HI	102	47.66%
4	Open and constant communication among stakeholders	HI	99	46.26%
5	Compatibility skills among stakeholders	HI	90	42.06%
<b>Risk Factors Group</b>				
6	Appropriate risk allocation and sharing among stakeholders	HI	110	51.40%
7	Timely securing of necessary access permits	HI	91	42.52%

No	Factor	Response	No	%
8	Timely access to the project site by Project Company	HI	102	47.66%
9	Effective operational risk management during the construction and operation stage	HI	98	45.79%
<b>Finance Factors Group</b>				
10	A competitive financial proposal by the Project Company	HI	103	48.13%
11	An effective payment mechanism to the Project Company during the operation stage	HI	105	49.07%
12	An effective life cycle cost analysis for the project by the project stakeholders	HI	112	52.34%
13	Government providing guarantees for the rate of return	HI	88	41.12%
14	Stable macroeconomic condition	HI	92	42.99%
<b>Legal Factors Group</b>				
15	Well-structured legal framework during construction and operation stages	HI	100	46.73%
16	Well written contract document protecting all project stakeholders	EI	108	50.47%
17	Well defined bidding process for the project	HI	93	43.46%
18	Availability of Government legislation and policies that support PPP initiatives	HI	101	47.20%
<b>Design Factors Group</b>				
19	Proper assessment of the environmental impact of the project	HI	91	42.52%
20	Utilization of innovation design technology (such as BIM-Building Information Modelling)	HI	91	42.52%
21	An effective design management plan	HI	100	46.73%
22	Consideration of sustainability in design, including modularity, post-event usage	HI	95	44.39%
<b>Construction Factors Group</b>				
23	Effective subcontractor selection procedure by the Project Company	HI	114	53.27%
24	Well defined construction period	HI	108	50.47%
25	Consistent and effective project performance monitoring	HI	125	58.41%
26	Effective safety management plan during construction and operation phase	HI	97	45.33%
27	Effective quality management plan during construction and operation phase	HI	113	52.80%
<b>Operation Factors Group</b>				
28	Effective management of operational problems during operation by the Project Company	HI	120	56.07%
29	Effective change management system in the operational contract agreements by the stakeholders	HI	110	51.40%
30	Well defined operation (concession) period	HI	115	53.74%
31	Long term demand for the project post-event	HI	98	45.79%
32	Consideration of sustainability in operation while maintaining service levels	HI	114	53.27%
<b>Sports Factors Group</b>				
33	Suitability of the size of the sports facility for usage after the event	HI	97	45.33%
34	Adaptability for the conversion of the sports facility after the event	HI	103	48.13%
35	Availability of other sports facilities with similar functions	HI	89	41.59%



### 4.3.2 Critical Success Factors Groups

This section will highlight and analyze the groups where the Critical Success Factors are considered part of the survey representing the respondents' thoughts in terms of importance.

Two hundred fourteen completed the entire survey will be discussed and analyzed after this. This part contained one question for eight groups. The factors are coded, and the responses are as shown below.

Table 22. Summary of the group responses on the groups – Original Data

Code/Response	NI	LI	MI	HI	EI					
Stakeholders related factors	0.47%	1	4.67%	10	20.56%	44	48.13%	103	26.17%	56
Risk related factors	0.47%	1	3.74%	8	21.50%	46	51.40%	110	22.90%	49
Finance related factors	0.47%	1	1.87%	4	14.02%	30	44.86%	96	38.79%	83
Legal related factors	0.47%	1	2.80%	6	19.16%	41	50.00%	107	27.57%	59
Design related factors	0.47%	1	1.40%	3	19.16%	41	45.79%	98	33.18%	71
Construction-related factors	0.47%	1	2.80%	6	19.63%	42	50.93%	109	26.17%	56
Operation related factors	0.47%	1	1.87%	4	18.22%	39	55.14%	118	24.30%	52
Sports Related factors	1.40%	3	7.94%	17	28.50%	61	45.79%	98	16.36%	35

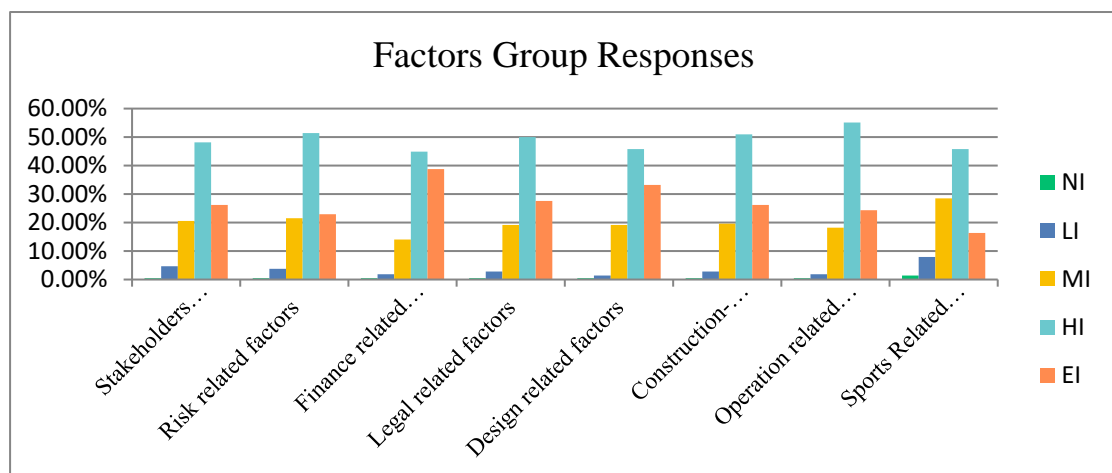

Figure 17. Summary of the group responses on the groups - Original Data

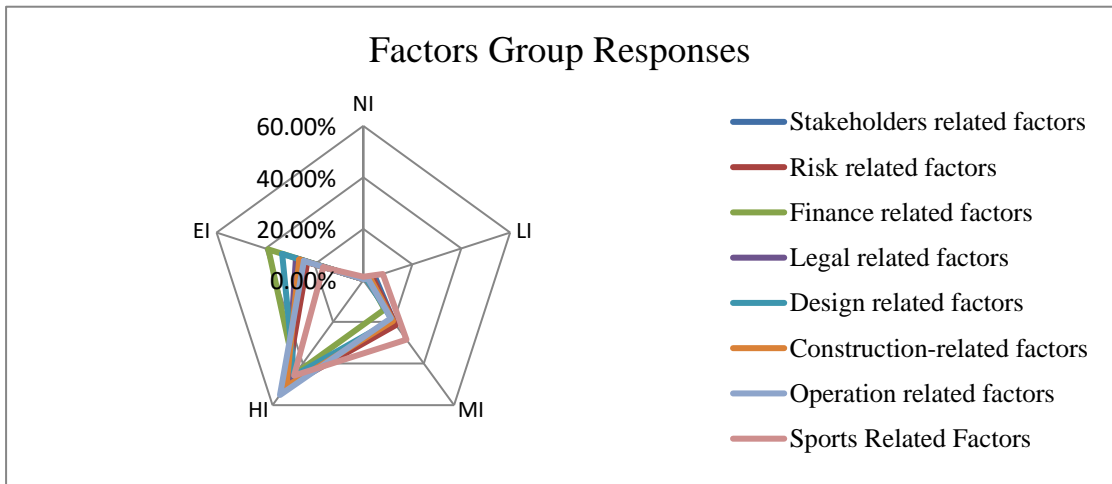

Figure 18. Summary of the group responses on the groups (Radar) – Original Data

The results indicate that all the groups fall under the High Importance Category with ranges of 118 response (55.14%) up to 96 responses (44.86%) out of the 214 completed responses received in the survey.

#### 4.3.3 Relative Importance Index (RII) – Original Data

This section will examine the importance of the individual critical success factors and the critical success factors groups using the Relative Important Index, which will be further validated using structural equation modelling.

This section will explain and illustrate the individual Critical Success Factors Ranking and the Critical Success Groups ranking.

The RII Value will be calculated using the following formula:

$$RII = \sum x_n x / (A * N)$$

Where:            x Scale of the responses (1 to 5)  
                       n Number of responses per scale

A Number of scale measures

N Total number of responses (214)

RII ranges from 0 to 1, and the more that result is approaching 1, the higher the importance level would be. According to Rooshdi et al. (2018), the RII ranking is as follows:

$0.8 \leq RII \leq 1$  is considered High.

$0.6 \leq RII \leq 0.8$  is considered High-Medium.

$0.4 \leq RII \leq 0.6$  is considered Medium.

$0.2 \leq RII \leq 0.4$  is considered Medium-Low.

$0 \leq RII \leq 0.2$  is considered Low.

Table 23 and 24 below calculate the RII and indicate the initial categorization of the individual Critical Success Factors Ranking and the Critical Success Groups Ranking.

Table 23. individual Critical Success Factors Ranking using RII – Original data

Factor	Likert Scale Point					N	Responses		RII	Rank
	NI	LI	MI	HI	EI		Min.	Max.		
L_2	1	3	20	82	108	214	1	5	0.87383	1
ST_4	1	2	33	99	79	214	1	5	0.83645	2
L_3	1	2	42	93	76	214	1	5	0.82523	3
ST_1	2	3	34	103	72	214	1	5	0.82430	4
F_2	3	4	30	105	72	214	1	5	0.82336	5
C_4	1	4	42	97	70	214	1	5	0.81589	6
R_3	1	8	34	102	69	214	1	5	0.81495	7
R_4	2	4	43	98	67	214	1	5	0.80935	8
F_1	1	5	41	103	64	214	1	5	0.80935	9
O_1	0	2	39	120	53	214	2	5	0.80935	10
C_3	1	5	31	125	52	214	1	5	0.80748	11
C_5	2	8	31	113	60	214	1	5	0.80654	12
L_1	2	4	44	100	64	214	1	5	0.80561	13
C_1	2	7	35	114	56	214	1	5	0.80093	14
D_3	0	9	44	100	61	214	2	5	0.79907	15
F_3	1	6	42	112	53	214	1	5	0.79626	16
L_4	1	7	46	101	59	214	1	5	0.79626	17

Factor	Likert Scale Point					N	Responses		RII	Rank
	NI	LI	MI	HI	EI		Min.	Max.		
C_2	1	6	46	108	53	214	1	5	0.79252	18
O_3	1	6	46	115	46	214	1	5	0.78598	19
R_1	2	7	47	110	48	214	1	5	0.78224	20
R_2	1	9	57	91	56	214	1	5	0.77944	21
O_2	0	11	47	110	46	214	2	5	0.77850	22
F_4	6	8	55	88	57	214	1	5	0.77009	23
D_1	1	7	65	91	50	214	1	5	0.77009	24
D_4	1	7	65	95	46	214	1	5	0.76636	25
O_4	1	8	64	98	43	214	1	5	0.76262	26
S_1	3	9	59	97	46	214	1	5	0.76262	27
O_5	1	8	59	114	32	214	1	5	0.75701	28
ST_3	1	13	60	102	38	214	1	5	0.75234	29
S_2	2	13	58	103	38	214	1	5	0.75140	30
F_5	2	7	75	92	38	214	1	5	0.74673	31
ST_2	4	15	58	95	42	214	1	5	0.74579	32
D_2	2	16	64	91	41	214	1	5	0.74299	33
ST_5	2	21	68	90	33	214	1	5	0.72243	34
S_3	9	19	79	89	18	214	1	5	0.68224	35

Table 24. Critical Success Factors Groups using RII – Original Data

Code/Response	NI	LI	MI	HI	EI	N	Min.	Max.	RII	Rank
Finance related factors	1	4	30	96	83	214	1	5	0.83925	1
Design related factors	1	3	41	98	71	214	1	5	0.81963	2
Legal related factors	1	6	41	107	59	214	1	5	0.80280	3
Operation related factors	1	4	39	118	52	214	1	5	0.80187	4
Construction-related factors	1	6	42	109	56	214	1	5	0.79907	5
Stakeholders related factors	1	10	44	103	56	214	1	5	0.78972	6
Risk related factors	1	8	46	110	49	214	1	5	0.78505	7
Sports Related factors	3	17	61	98	35	214	1	5	0.73551	8

The data at this stage have not gone through any treatment yet to identify any outliers.

However, the ranking will be further validated after removing the outliers and with the Structural Equation Modelling outcomes and SPSS software.

#### 4.4 Collected Data and Data treatment

In this section, the study will explain how the data was treated based on the previous section's responses.

##### *4.4.1 Test for Outliers*

The data was transformed from Excel to SPSS statistics software, and the responses were adjusted to enable the software to read them properly. Table 25 below shows the new coding adapted for this purpose.

Table 25. Response Criteria and coding

<b>Item</b>	<b>Code</b>	<b>Numb Code</b>
Not Important	NI	1
Low Important	LI	2
Moderate Important	MI	3
High Important	HI	4
Extremely Important	EI	5

Once the data is converted, the first structural equation model was built, and the data was uploaded in SPSS AMOS to determine their fitness and screen them from the outliers (if any).

The basic model concept considered the survey results (the critical success factors) as observed variables with a unique factor attached to each of them with a straight path connecting the groups (identified as unobserved variables). The unobserved variables had a covariance relationship among all of them and connecting all of them.

The first run was to test the model in terms of Normality and outliers using the distance from the centroid (Mahalanobis distance).

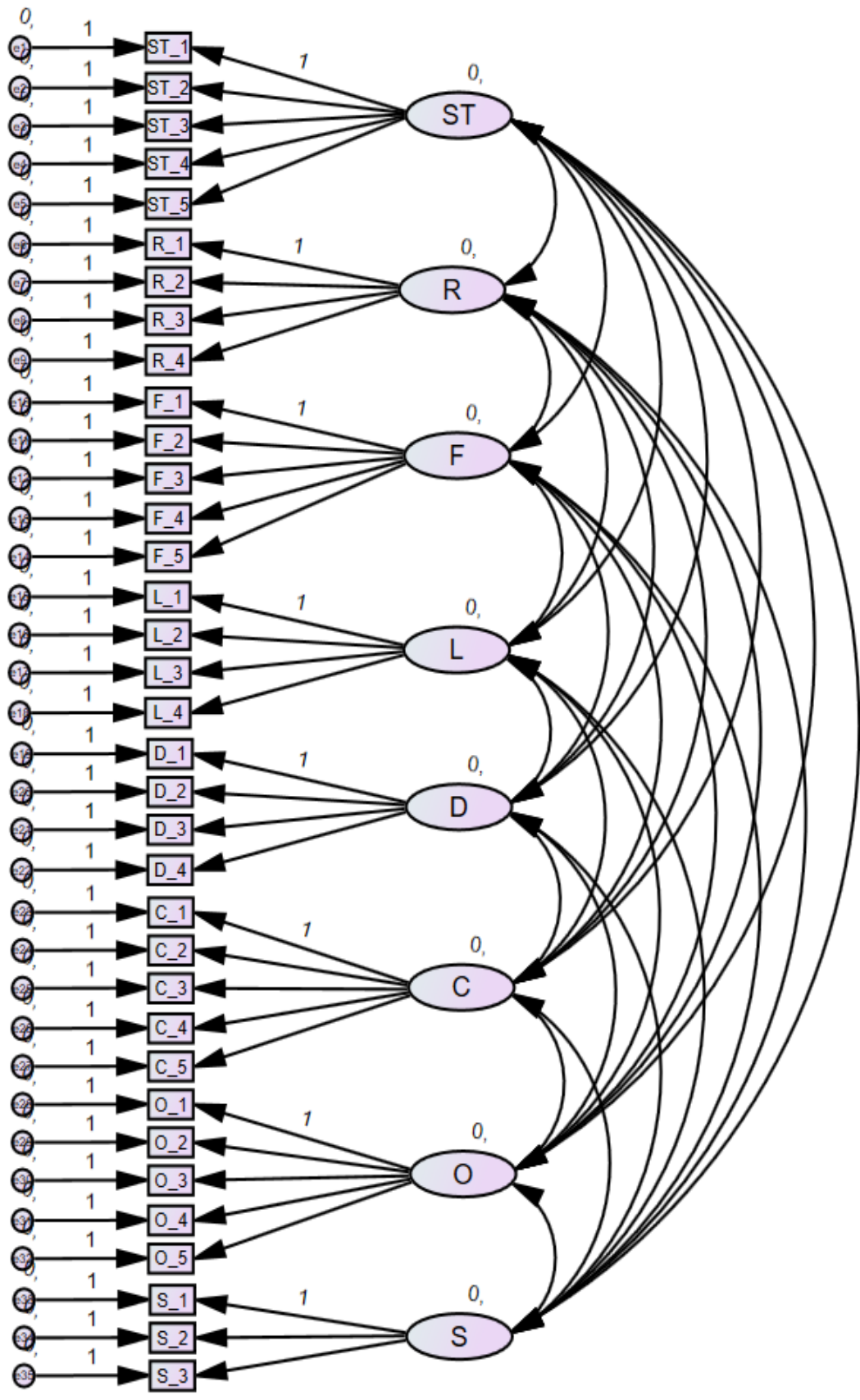

Figure 19. First SEM model – Individual Factors

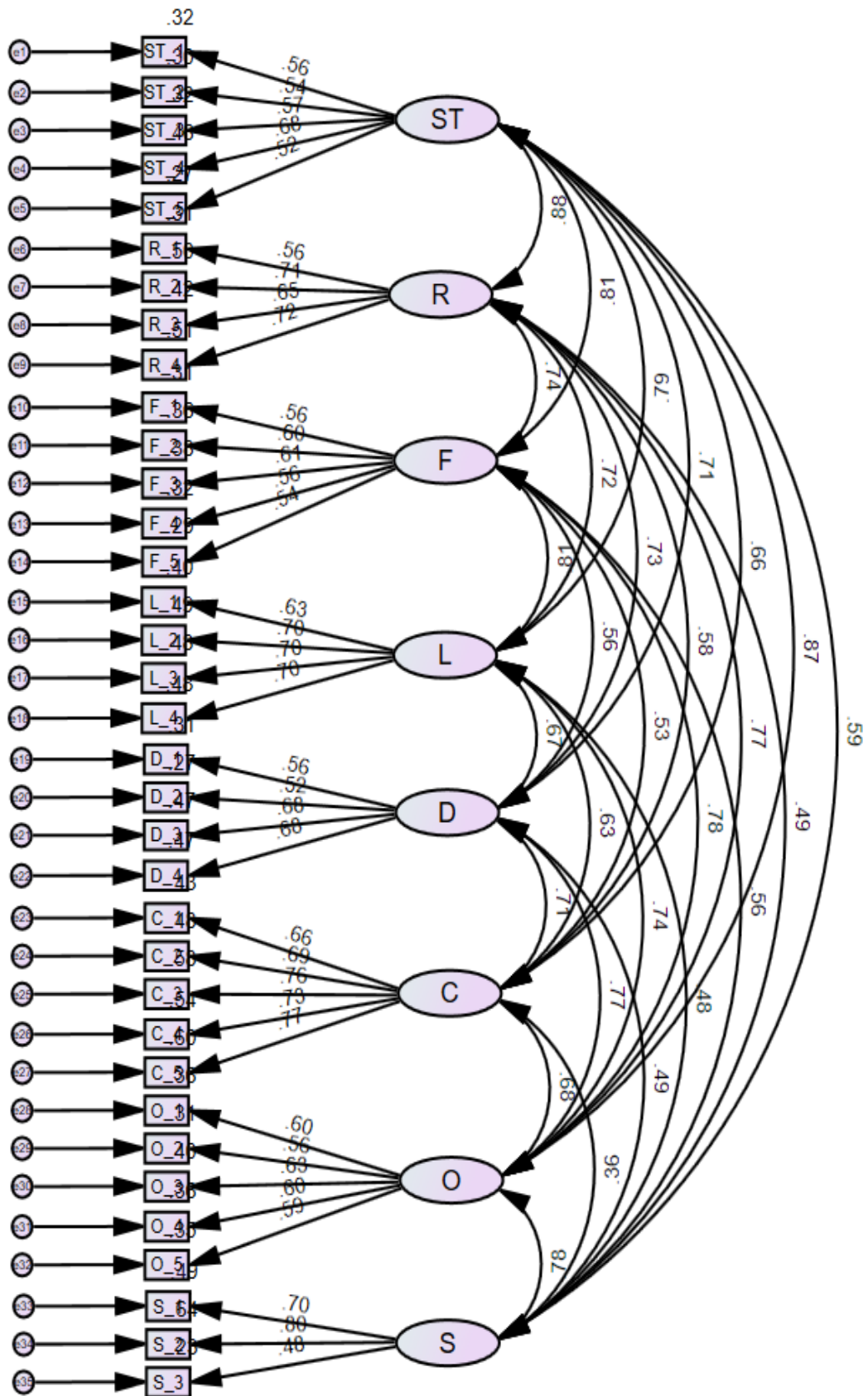

Figure 20. First SEM model results – Individual factors

The first run indicated that there are possible 42 responses that could be an outlier. However, this was because P1 resulted from the distance from the centroid (Mahalanobis distance) are lesser than 0.5.

Given the results obtained, the data has to undergo a screening to identify and remove any outlier that could impact the model fitness.

Table 26. Observations farthest from the centroid (Mahalanobis distance) – Individual factors

<b>Observation number</b>	<b>Mahalanobis d-squared</b>	<b>p1</b>	<b>Observation number</b>	<b>Mahalanobis d-squared</b>	<b>p1</b>
122	116.602	0	65	55.748	0.014
64	99.556	0	179	55.734	0.014
14	95.124	0	165	55.683	0.015
142	71.951	0	59	55.296	0.016
137	69.33	0	176	55.016	0.017
101	68.507	0.001	164	54.926	0.017
82	67.281	0.001	145	54.422	0.019
12	67.098	0.001	92	53.791	0.022
15	63.468	0.002	36	53.582	0.023
173	63.246	0.002	89	53.537	0.023
170	63.002	0.003	54	53.534	0.023
97	62.834	0.003	178	53.366	0.024
85	62.605	0.003	48	53.178	0.025
159	61.181	0.004	199	53.077	0.026
212	59.68	0.006	11	51.959	0.032
51	59.384	0.006	130	51.57	0.035
187	58.774	0.007	181	51.499	0.036
149	58.398	0.008	106	51.175	0.038
169	58.146	0.008	214	50.118	0.047
207	57.186	0.01	211	50.11	0.047
146	56.841	0.011	118	50.022	0.048

According to the results, another examination for outliers was done using Mahalanobis distance and probability, so any response with less than 0.05 was removed.



Table 27. Outliers result from the SPSS software – Individual factors

ID	MD	ID	MD	ID	MD
122	0	187	0.0056	178	0.01947
64	0	149	0.00613	48	0.02029
14	0	169	0.00651	199	0.02074
142	0.00017	207	0.00818	11	0.02637
137	0.00036	146	0.00887	130	0.02863
101	0.00045	65	0.01142	181	0.02906
82	0.00063	179	0.01146	106	0.0311
12	0.00066	165	0.01159	214	0.03866
15	0.00173	59	0.01266	211	0.03872
173	0.00183	176	0.01349	118	0.03941
170	0.00195	164	0.01377	25	0.04306
97	0.00204	145	0.01542	60	0.04728
85	0.00216	92	0.01774	81	0.04743
159	0.0031	36	0.01857	126	0.04908
212	0.00449	89	0.01876		
51	0.00483	54	0.01877		

46 response out of 214 were identified as outliers for the individual Critical Success Factors. This has resulted in reducing the study data to 168 response.

The study will undergo the same steps above for the group factors, and the results are as below.

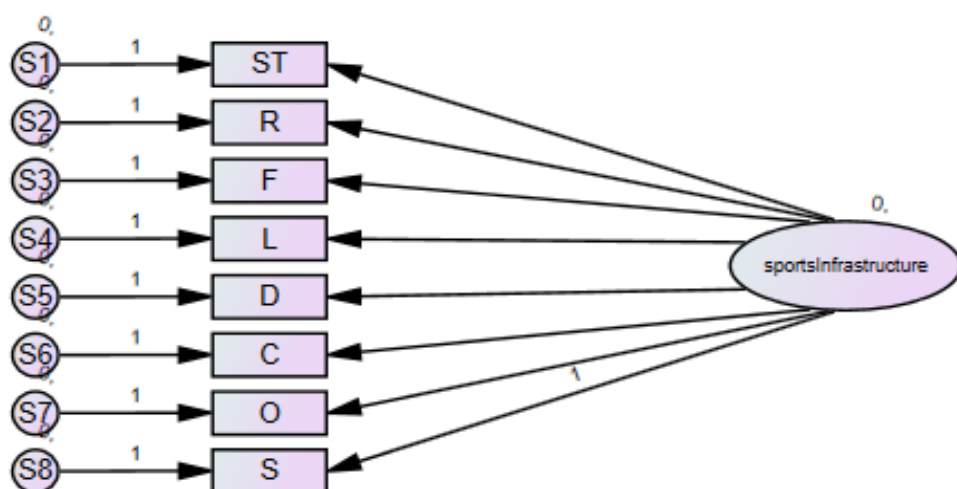

Figure 21. First SEM model – Group Factors

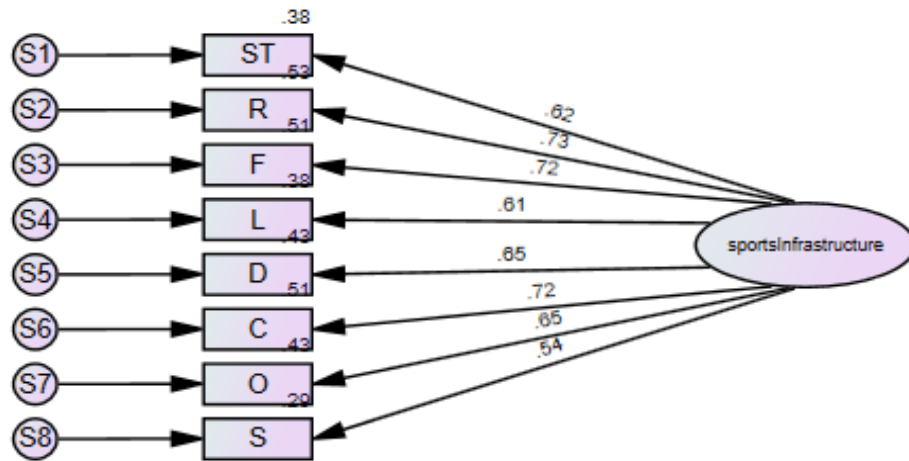

Figure 22. First SEM model results – Group Factors

The results show that 24 responses are suspected to be outliers in examining the individuals and group factors. Ten answers are presumed under the group factor test, as shown in Table 28 below.

Table 28. Observations farthest from the centroid (Mahalanobis distance) – Group Factors

Observation number	Mahalanobis d-squared	p1	Observation number	Mahalanobis d-squared	p1
101	48.056	0	169	19.267	0.013
122	32.608	0	150	18.623	0.017
149	31.969	0	163	18.543	0.018
97	28.407	0	210	17.834	0.023
81	26.035	0.001	131	17.588	0.025
85	23.692	0.003	212	17.561	0.025
178	23.087	0.003	155	17.468	0.026
199	23.06	0.003	4	16.901	0.031
103	21.345	0.006	54	16.703	0.033
30	20.956	0.007	142	16.439	0.037
159	20.854	0.008	130	15.921	0.044
197	20.018	0.01	89	15.549	0.049

According to the results, another examination for outliers was completed using Mahalanobis distance and probability for the critical success factors groups. Hence, the

study considers any response with less than 0.05 as an outlier and to be removed.

However, there were no outliers reported part of the test. Yet, for more conformity of the data, the following treatment was decided:

Step 1: Remove all outliers identified in the individual CSF test (46 Responses)

Step 2: Remove the same outliers (46) from the critical success factors groups

The above steps have resulted in the removal of 46 response, as shown in Table 29.

Table 29. Outliers analysis – individual and group factors

Observation number	Mahalanobis d-squared	p1	Observation number	Mahalanobis d-squared	p1	Common	Status
			4	16.901	0.031	No	Kept
14	95.124	0				No	Removed
64	99.556	0				No	Removed
122	116.602	0	122	32.608	0	Yes	Removed
137	69.33	0				No	Removed
			30	20.956	0.007	No	Kept
142	71.951	0	142	16.439	0.037	Yes	Removed
12	67.098	0.001				No	Removed
82	67.281	0.001				No	Removed
101	68.507	0.001	101	48.056	0	Yes	Removed
15	63.468	0.002				No	Removed
173	63.246	0.002				No	Removed
85	62.605	0.003	85	23.692	0.003	Yes	Removed
81	48.86835	0.0474	81	26.035	0.001	Yes	Removed
97	62.834	0.003	97	28.407	0	Yes	Removed
170	63.002	0.003				No	Removed
159	61.181	0.004	159	20.854	0.008	Yes	Removed
51	59.384	0.006				No	Removed
212	59.68	0.006	212	17.561	0.025	Yes	Removed
187	58.774	0.007				No	Removed
			103	21.345	0.006	No	Kept
149	58.398	0.008	149	31.969	0	Yes	Removed
169	58.146	0.008	169	19.267	0.013	Yes	Removed
207	57.186	0.01				No	Removed
146	56.841	0.011				No	Removed
			131	17.588	0.025	No	Kept
65	55.748	0.014				No	Removed
179	55.734	0.014				No	Removed
165	55.683	0.015				No	Removed
59	55.296	0.016				No	Removed
164	54.926	0.017				No	Removed
			150	18.623	0.017	No	Kept
			155	17.468	0.026	No	Kept
176	55.016	0.017				No	Removed
			163	18.543	0.018	No	Kept
145	54.422	0.019				No	Removed

Observation number	Mahalanobis d-squared	p1	Observation number	Mahalanobis d-squared	p1	Common	Status
92	53.791	0.022				No	Removed
36	53.582	0.023				No	Removed
54	53.534	0.023	54	16.703	0.033	Yes	Removed
89	53.537	0.023	89	15.549	0.049	Yes	Removed
178	53.366	0.024	178	23.087	0.003	Yes	Removed
48	53.178	0.025				No	Removed
199	53.077	0.026	199	23.06	0.003	Yes	Removed
11	51.959	0.032				No	Removed
130	51.57	0.035	130	15.921	0.044	Yes	Removed
181	51.499	0.036	197	20.018	0.01	No	Kept
106	51.175	0.038				No	Removed
			210	17.834	0.023	No	Kept
211	50.11	0.047				No	Removed
214	50.118	0.047				No	Removed
118	50.022	0.048				No	Removed
126	48.6961	0.0491				No	Removed
25	49.35158	0.0431				No	Removed
60	48.88427	0.0473				No	Removed

Accordingly, a new set of revised data will be used to analyze the importance of RII to the SEM so that a consistency based on more reliable data is obtained.

Simultaneously, and despite the omission of 46 response out of 214 response, the remaining data (168 responses) are sufficient to have a reliable model.

#### 4.4.2 Test for Normality

The data also require being tested for Normality after removing the outliers as described in the previous section. The non-normal data can result and lead to inflations of the results such as inflating the chi-square, deflate the standard error and bias the coefficient significance. The study will use SPSS Statistics to examine the non-normality.

Both skewness and kurtosis values resulted from the Normality test needs to be

examined as they are representative of the univariate non-normal data. Absolute values of skewness and kurtosis more than extreme ones are an indication of non-normality. The critical ration (c.r.) should be between -1.96 & +1.96 for responses less than 50 and between -3.29 & +3.29 for responses exceeding 50 up to 300.

#### 4.4.2.1 Normality for individual Critical Success Factors

When using SPSS Statistics, the results are shown below:

Table 30. Skewness and Kurtosis results – Individual Critical Success Factors

Factor	Mean	Std. Deviation	Skewness				Kurtosis			
			Statistic	Std. Error	cr	Status	Statistic	Std. Error	cr	Status
ST_1	4.18	0.729	-0.759	0.187	-4.053	X	1.252	0.373	3.360	X
ST_2	3.79	0.840	-0.573	0.187	-3.057	√	0.537	0.373	1.440	√
ST_3	3.81	0.819	-0.430	0.187	-2.294	√	0.149	0.373	0.401	√
ST_4	4.26	0.726	-0.814	0.187	-4.346	X	1.155	0.373	3.101	√
ST_5	3.71	0.850	-0.347	0.187	-1.854	√	-0.119	0.373	-0.319	√
R_1	3.97	0.738	-0.587	0.187	-3.135	√	1.012	0.373	2.716	√
R_2	3.98	0.815	-0.437	0.187	-2.333	√	-0.017	0.373	-0.046	√
R_3	4.13	0.763	-0.882	0.187	-4.707	X	1.419	0.373	3.809	X
R_4	4.13	0.727	-0.574	0.187	-3.065	√	0.778	0.373	2.088	√
F_1	4.10	0.760	-0.658	0.187	-3.515	X	0.794	0.373	2.130	√
F_2	4.13	0.705	-0.708	0.187	-3.780	X	1.528	0.373	4.102	X
F_3	4.01	0.718	-0.608	0.187	-3.247	√	1.247	0.373	3.348	X
F_4	3.90	0.856	-0.626	0.187	-3.341	X	0.507	0.373	1.360	√
F_5	3.74	0.758	-0.201	0.187	-1.074	√	0.209	0.373	0.561	√
L_1	4.10	0.755	-0.592	0.187	-3.160	√	0.610	0.373	1.637	√
L_2	4.38	0.715	-1.192	0.187	-6.364	X	2.301	0.373	6.177	X
L_3	4.16	0.753	-0.701	0.187	-3.740	X	0.808	0.373	2.169	√
L_4	4.03	0.746	-0.487	0.187	-2.598	√	0.569	0.373	1.527	√
D_1	3.89	0.800	-0.290	0.187	-1.549	√	-0.057	0.373	-0.154	√
D_2	3.80	0.768	-0.049	0.187	-0.262	√	-0.574	0.373	-1.542	√
D_3	4.07	0.702	-0.302	0.187	-1.610	√	-0.258	0.373	-0.691	√
D_4	3.91	0.733	-0.044	0.187	-0.236	√	-0.693	0.373	-1.860	√
C_1	4.12	0.673	-0.264	0.187	-1.411	√	-0.334	0.373	-0.897	√
C_2	4.06	0.698	-0.188	0.187	-1.005	√	-0.579	0.373	-1.553	√
C_3	4.12	0.636	-0.387	0.187	-2.063	√	0.581	0.373	1.561	√
C_4	4.19	0.692	-0.381	0.187	-2.035	√	-0.445	0.373	-1.195	√
C_5	4.17	0.654	-0.314	0.187	-1.674	√	-0.142	0.373	-0.382	√
O_1	4.11	0.648	-0.239	0.187	-1.277	√	-0.102	0.373	-0.274	√
O_2	3.98	0.705	-0.287	0.187	-1.530	√	-0.094	0.373	-0.253	√
O_3	3.98	0.652	-0.114	0.187	-0.607	√	-0.218	0.373	-0.584	√
O_4	3.86	0.728	-0.056	0.187	-0.297	√	-0.516	0.373	-1.385	√
O_5	3.88	0.649	-0.139	0.187	-0.743	√	-0.006	0.373	-0.016	√
S_1	3.88	0.757	-0.134	0.187	-0.714	√	-0.531	0.373	-1.426	√
S_2	3.81	0.742	-0.213	0.187	-1.135	√	-0.209	0.373	-0.560	√
S_3	3.51	0.774	-0.472	0.187	-2.519	√	0.914	0.373	2.453	√

The obtained results indicate some non-normality associated with some factors, which was identified in table 31 below. Accordingly, to address the non-normality of some factors, we will use bootstrapping up to 2000 samples to find the bollen-stine boot-strap value and explore more data and give more presentation to the public.

Table 31. Non-normality individual critical success factors

Factor	Skewness				Kurtosis			
	Statistic	Std. Error	cr	Status	Statistic	Std. Error	cr	Status
ST_1	-0.759	0.187	-4.053	X	1.252	0.373	3.360	X
ST_4	-0.814	0.187	-4.346	X				
R_3	-0.882	0.187	-4.707	X	1.419	0.373	3.809	X
F_1	-0.658	0.187	-3.515	X				
F_2	-0.708	0.187	-3.780	X	1.528	0.373	4.102	X
F_3					1.247	0.373	3.348	X
F_4	-0.626	0.187	-3.341	X				
L_2	-1.192	0.187	-6.364	X	2.301	0.373	6.177	X
L_3	-0.701	0.187	-3.740	X				

#### 4.4.2.2 Normality for Critical Success Factor groups

When using SPSS Statistics similar to what was completed before, the results are shown below:

Table 32. Skewness and Kurtosis results – Critical Success groups

Group	Mean	Std. Deviation	Skewness				Kurtosis			
			Statistic	Std. Error	cr	Status	Statistic	Std. Error	cr	Status
Stakeholders	4.08	0.750	-0.472	0.187	-2.520	√	-0.120	0.373	-0.321	√
Risk	4.00	0.718	-0.295	0.187	-1.576	√	-0.199	0.373	-0.535	√
Finance	4.18	0.755	-0.574	0.187	-3.063	√	-0.243	0.373	-0.652	√
Legal	4.07	0.727	-0.385	0.187	-2.053	√	-0.187	0.373	-0.501	√
Design	4.13	0.705	-0.294	0.187	-1.569	√	-0.591	0.373	-1.587	√
Construction	4.07	0.697	-0.312	0.187	-1.667	√	-0.202	0.373	-0.542	√
Operation	4.01	0.679	-0.240	0.187	-1.279	√	-0.097	0.373	-0.261	√
Sports	3.76	0.783	-0.158	0.187	-0.844	√	-0.406	0.373	-1.090	√

There is no non-normality reported in the Group critical success factors; however, we will perform bootstrap to explore the data more widely.

## 4.5 Descriptive Analysis – Modified Data

This section will discuss the modified data obtained from the survey with data treatment, including removing the outliers for both individual critical success factors and critical success factors groups.

### 4.5.1 Individual Critical Success Factors

#### *Stakeholders Factors Group*

The revised data for the Five critical success factors listed under this group are as follows:

Table 33. Stakeholder Group Factor responses – Modified Data

Code/Response	NI	LI	MI	HI	EI					
ST_1	0.60%	1	0.60%	1	13.69%	23	50.60%	85	34.52%	58
ST_2	1.19%	2	4.76%	8	26.19%	44	49.40%	83	18.45%	31
ST_3	0.60%	1	4.76%	8	26.79%	45	48.81%	82	19.05%	32
ST_4	0.60%	1	0.00%	0	13.10%	22	45.83%	77	40.48%	68
ST_5	0.60%	1	7.14%	12	29.76%	50	45.83%	77	16.67%	28

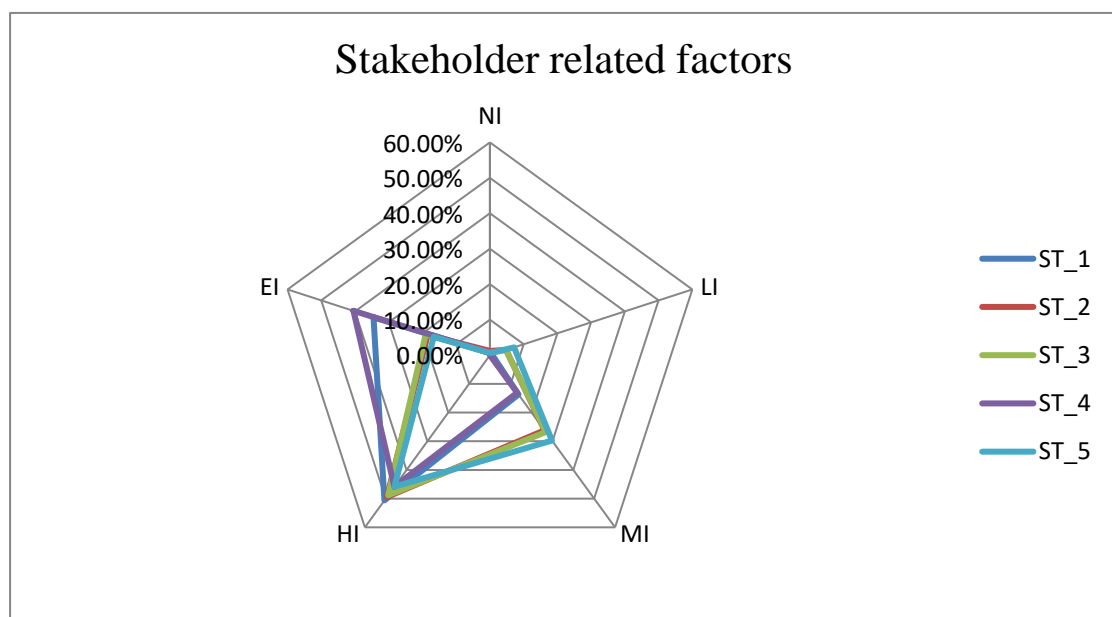

Figure 23. Stakeholder Group Factor responses – Modified Data

The results indicate that all the factors are still falling under the High Importance Category with 85 responses against 103 response using the original data (50.70% V.s 48.13%) up to 77 responses against 90 responses (45.83% V.s 42.06%). Despite reducing the responses, the percentages have increased when comparing the first data set with the modified data.

### *Risk Factors Group*

The revised data for the Four critical success factors listed under this group are as follows:

Table 34. Risk Group Factor responses – Modified Data

Code/Response	NI	LI	MI	HI	EI					
R_1	0.60%	1	1.79%	3	19.64%	33	55.95%	94	22.02%	37
R_2	0.60%	1	1.79%	3	25.00%	42	44.05%	74	28.57%	48
R_3	0.60%	1	2.38%	4	12.50%	21	52.38%	88	32.14%	54
R_4	0.60%	1	0.00%	0	17.26%	29	50.60%	85	31.55%	53

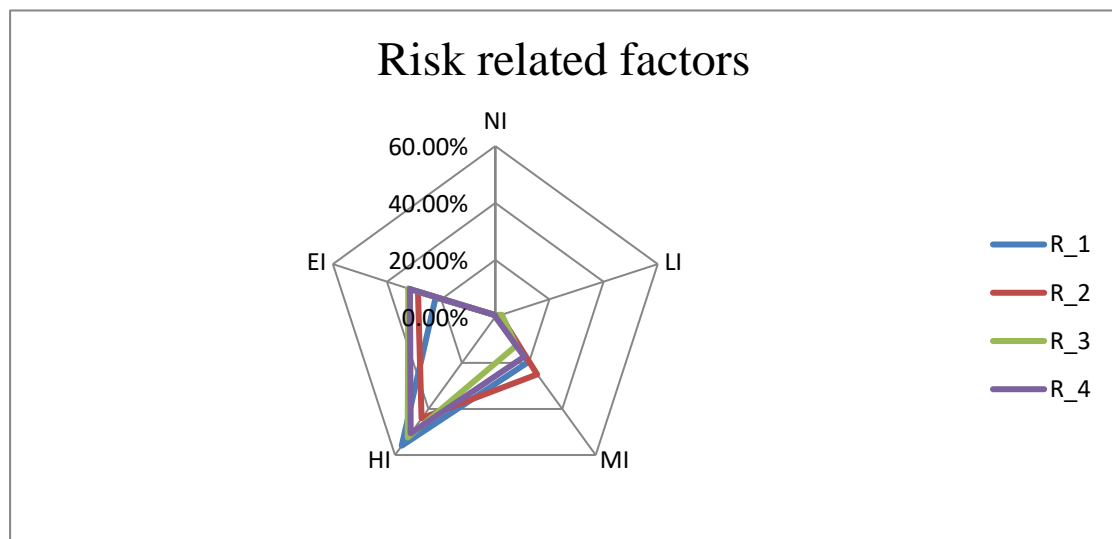

Figure 24. Risk Group Factor responses – Modified Data

The results indicate that all the factors are still falling under the High Importance Category, with ranges of 94 responses against 110 response using the original data (55.95% V.s 51.40%) up to 74 responses against 91 responses (44.05% V.s 42.52%).



Despite reducing the responses, the percentages have increased when comparing the first data set with the modified data.

### *Finance Factors Group*

The revised data for the Five critical success factors listed under this group are as follows:

Table 35. Finance Group Factor responses – Modified Data

Code/Response	NI	LI	MI	HI	EI					
F_1	0.60%	1	1.19%	2	17.26%	29	50.00%	84	30.95%	52
F_2	0.60%	1	0.60%	1	13.69%	23	55.36%	93	29.76%	50
F_3	0.60%	1	1.19%	2	17.86%	30	57.14%	96	23.21%	39
F_4	1.19%	2	3.57%	6	23.81%	40	46.43%	78	25.00%	42
F_5	0.60%	1	2.38%	4	33.93%	57	48.21%	81	14.88%	25

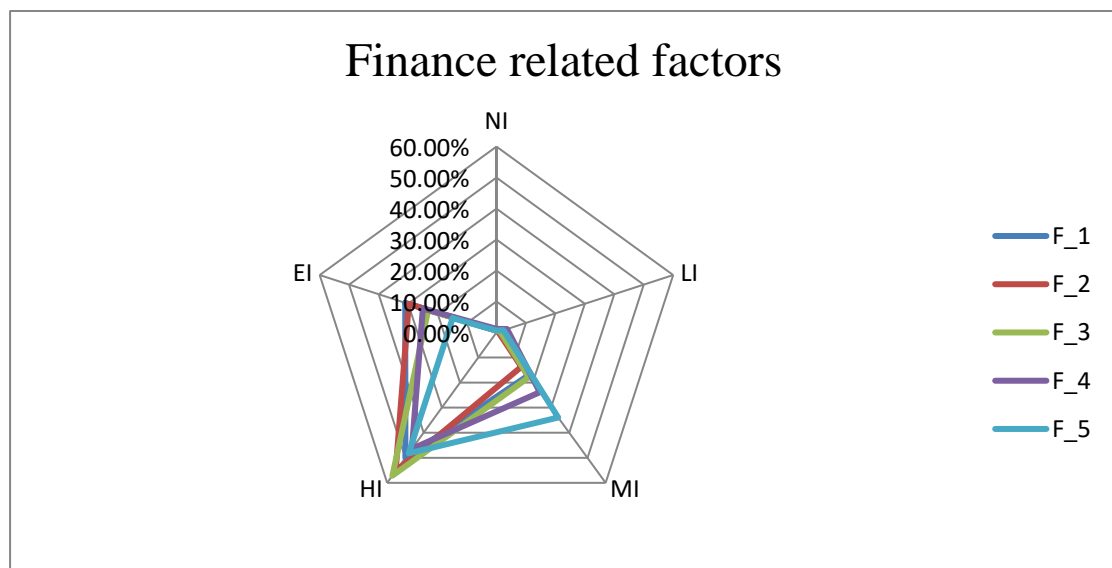

Figure 25. Finance Group Factor responses – Modified Data

The results indicate that all the factors are still falling under the High Importance Category, with ranges of 96 responses against 112 response using the original data (57.14% V.s 52.34%) up to 78 responses against 88 responses (46.43% V.s 41.12%). Despite reducing the responses, the percentages have increased when comparing the first data set with the modified data.

### Legal Factors Group

The revised data for the Four critical success factors listed under this group are as follows:

Table 36. Legal Group Factor responses – Modified Data

Code/Response	NI		LI		MI		HI		EI	
L_1	0.60%	1	0.60%	1	18.45%	31	48.81%	82	31.55%	53
L_2	0.60%	1	0.60%	1	8.33%	14	41.67%	70	48.81%	82
L_3	0.60%	1	0.60%	1	16.07%	27	47.62%	80	35.12%	59
L_4	0.60%	1	0.60%	1	20.83%	35	51.19%	86	26.79%	45

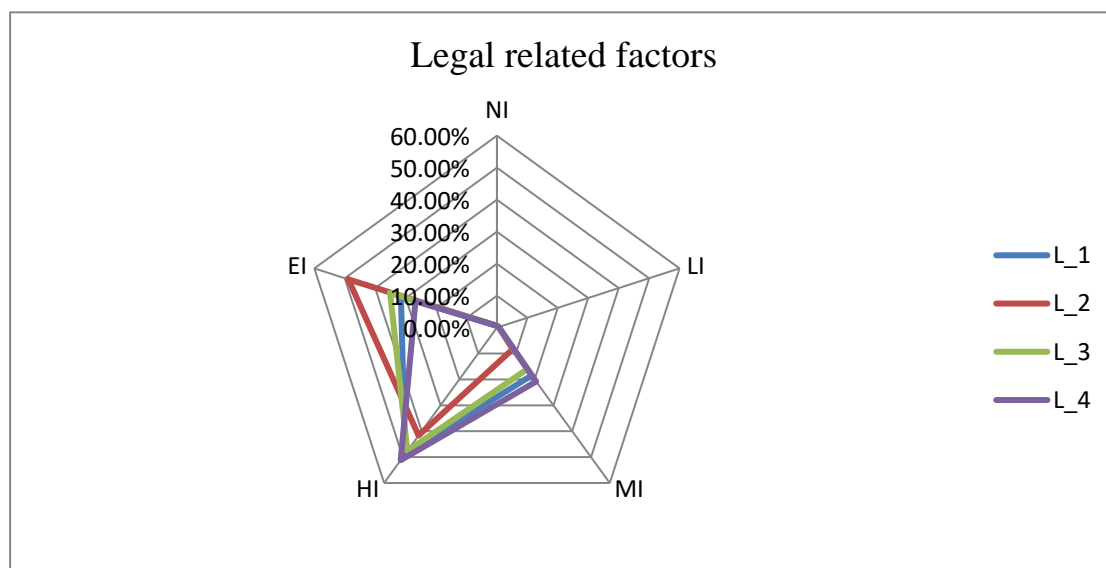

Figure 26. Legal Group Factor responses – Modified Data

This indicates that all the groups are still falling under the High Importance Category with ranges of 86 responses against 101 response (51.19% V.s 47.20%) up to 70 responses against 93 responses (41.76% V.s 38.32%) except for one factor that was categorized under extremely important with 82 responses against 108 responses (48.81% V.s 50.47%) which is the only case reported in the survey. Despite reducing the responses, the percentages have increased when comparing the first data set with the modified data except for the factor mentioned above (L\_2).

### Design Factors Group

The revised data for the Four critical success factors listed under this group are as follows:

Table 37. Design Group Factor responses – Modified Data

Code/Response	NI	LI	MI	HI	EI
D_1	0.60% 1	1.79% 3	29.17% 49	45.24% 76	23.21% 39
D_2	0.00% 0	2.98% 5	32.14% 54	46.43% 78	18.45% 31
D_3	0.00% 0	1.19% 2	17.86% 30	54.17% 91	26.79% 45
D_4	0.00% 0	1.19% 2	27.98% 47	49.40% 83	21.43% 36

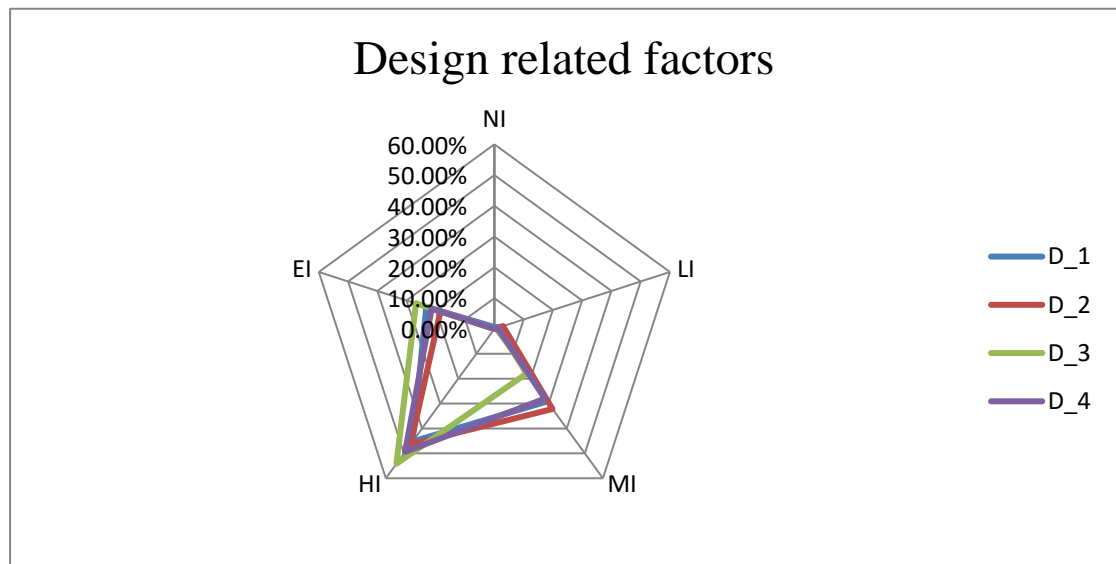

Figure 27. Design Group Factor responses – Modified Data

The results indicate that all the factors are still falling under the High Importance Category, with ranges of 91 responses against 100 response using the original data (54.17% V.s 46.73%) up to 76 responses against 91 responses (45.24% V.s 42.52%). Despite reducing the responses, the percentages have increased when comparing the first data set with the modified data.

### Construction Factors Group

The revised data for the Five critical success factors listed under this group are as follows:

Table 38. Construction Group Factor responses – Modified Data

Code/Response	NI	LI	MI	HI	EI
C_1	0.00% 0	0.60% 1	15.48% 26	55.36% 93	28.57% 48
C_2	0.00% 0	0.60% 1	19.64% 33	52.98% 89	26.79% 45
C_3	0.00% 0	1.19% 2	11.31% 19	61.90% 104	25.60% 43
C_4	0.00% 0	0.60% 1	14.29% 24	50.60% 85	34.52% 58
C_5	0.00% 0	0.60% 1	12.50% 21	56.55% 95	30.36% 51

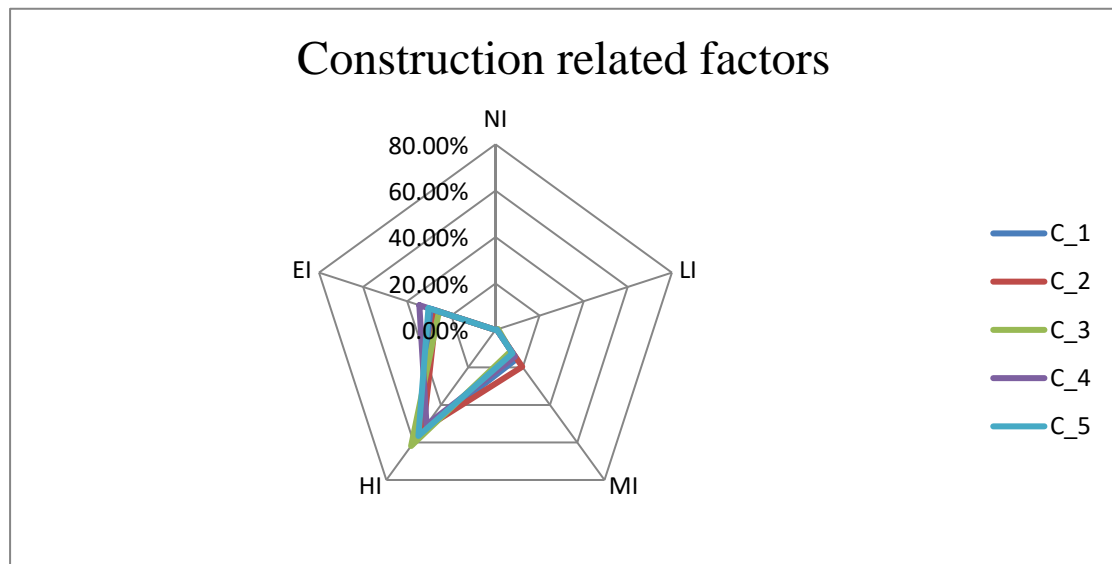

Figure 28. Construction Group Factor responses – Modified Data

The results indicate that all the factors are still falling under the High Importance Category, with ranges of 104 responses against 125 response using the original data (61.90% V.s 58.41%) up to 85 responses against 97 responses (50.60% V.s 45.33%). Despite reducing the responses, the percentages have increased when comparing the first data set with the modified data.

### Operation Factors Group

The revised data for the Five critical success factors listed under this group are as follows:

Table 39. Operation Group Factor responses – Modified Data

Code/Response	NI	LI	MI	HI	EI
O_1	0.00% 0	0.60% 1	14.29% 24	58.93% 99	26.19% 44
O_2	0.00% 0	1.79% 3	20.24% 34	55.95% 94	22.02% 37
O_3	0.00% 0	0.60% 1	20.24% 34	59.52% 100	19.64% 33
O_4	0.00% 0	1.79% 3	29.17% 49	50.60% 85	18.45% 31
O_5	0.00% 0	1.19% 2	24.40% 41	60.12% 101	14.29% 24

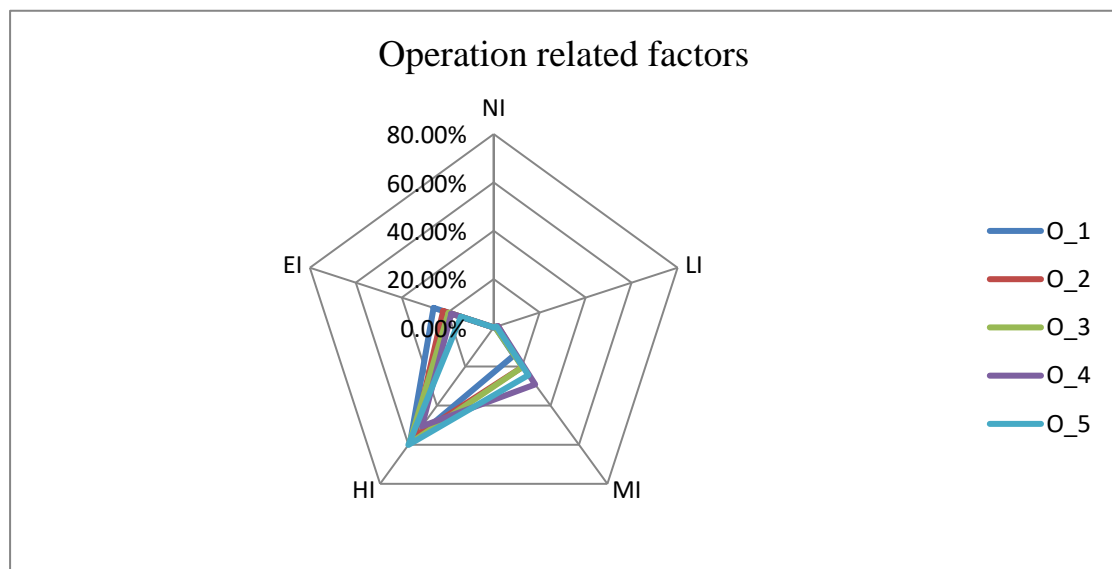

Figure 29. Operation Group Factor responses – Modified Data

The results indicate that all the factors are still falling under the High Importance Category with 101 responses against 120 response using the original data (60.12% V.s 56.07%) up to 85 response 98 responses (50.60% V.s 45.79%). Despite reducing the responses, the percentages have increased when comparing the first data set with the modified data.

*Sports Factors Group*

The revised data for the Three critical success factors listed under this group are as follows:

Table 40. Sports Group Factor responses – Modified Data

Code/Response	NI	LI	MI	HI	EI
S_1	0.00% 0	2.38% 4	27.98% 47	48.81% 82	20.83% 35
S_2	0.00% 0	3.57% 6	27.98% 47	52.38% 88	16.07% 27
S_3	1.79% 3	4.76% 8	41.07% 69	45.24% 76	7.14% 12

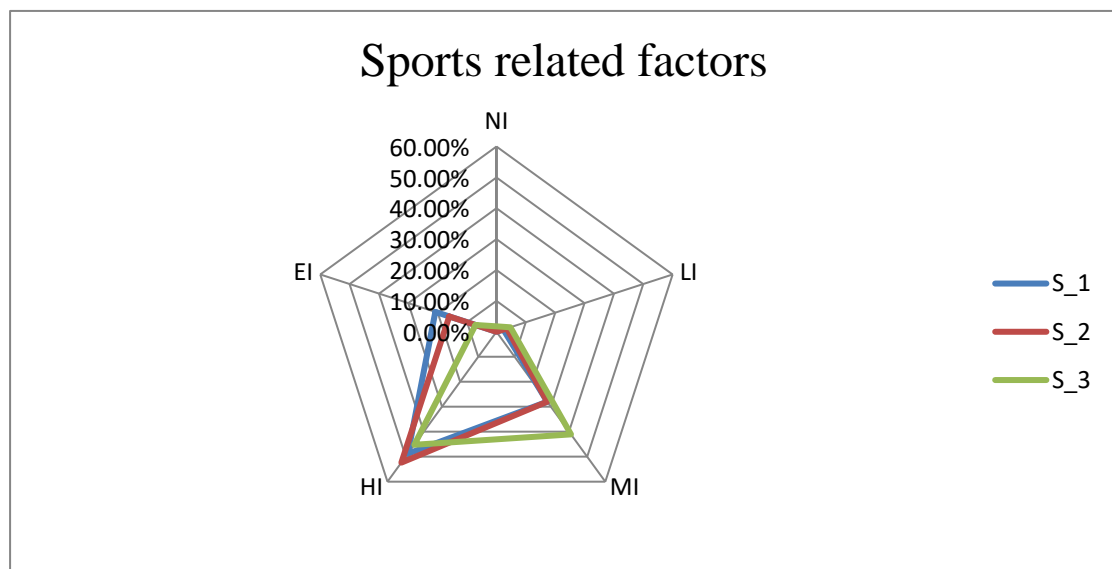

Figure 30. Sports Group Factor responses – Modified Data

The results indicate that all the factors are still falling under the High Importance Category with ranges of 88 responses against 103 response using the original data (52.38% V.s 48.13%) up to 76 responses against 89 responses (45.24% V.s 41.59%). Despite reducing the responses, the percentages have increased when comparing the first data set with the modified data.

*Summary of all Data – Modified Data*

In the second observation, we can see that on the modified data, most of the responses indicated that all the factors are High Importance with ranges varying from 74 responses against 88 response (44.05% V.s 41.12%) up to 104 responses against 125 responses (61.90 V.s 58.41%) except for one factor that falls under the legal category (Well written contract document protecting all project stakeholders) which still considered as per the response Extremely Important with 82 responses against 108 answers (48.81 % V.s 50.47%) confirming the same. Despite reducing the responses, the percentages have increased when comparing the first data set with the modified data. Except for the extremely important item where the percentage has decreased slightly, but still categorized the only extremely important factor as per the survey result.

Table 41. Summary of the highest responses on the Critical Factors –Modified Data

No.	Factor	Response	No.	%
<b>Stakeholders Factors Group</b>				
1	Clarity of roles and responsibilities among stakeholders	HI	85	50.60%
2	Realistic sharing of income by stakeholders	HI	83	49.40%
3	Public/community support to the project	HI	82	48.81%
4	Open and constant communication among stakeholders	HI	77	45.83%
5	Compatibility skills among stakeholders	HI	77	45.83%
<b>Risk Factors Group</b>				
6	Appropriate risk allocation and sharing among stakeholders	HI	94	55.95%
7	Timely securing of necessary access permits	HI	74	44.05%
8	Timely access to the project site by Project Company	HI	88	52.38%
9	Effective operational risk management during the construction and operation stage	HI	85	50.60%
<b>Finance Factors Group</b>				
10	A competitive financial proposal by the Project Company	HI	84	50.00%
11	An effective payment mechanism to the Project Company during the operation stage	HI	93	55.36%
12	An effective life cycle cost analysis for the project by the project stakeholders	HI	96	57.14%
13	Government providing guarantees for the rate of return	HI	78	46.43%
14	Stable macroeconomic condition	HI	81	48.21%
<b>Legal Factors Group</b>				
15	Well-structured legal framework during construction and operation stages	HI	82	48.81%
16	Well written contract document protecting all project stakeholders	EI	82	48.81%
17	Well defined bidding process for the project	HI	80	47.62%
18	Availability of Government legislation and policies that support PPP initiatives	HI	86	51.19%

No.	Factor	Response	No.	%
<b>Design Factors Group</b>				
19	Proper assessment of the environmental impact of the project	HI	76	45.24%
20	Utilization of innovation design technology (such as BIM- Building Information Modelling)	HI	78	46.43%
21	An effective design management plan	HI	91	54.17%
22	Consideration of sustainability in design, including modularity, post-event usage	HI	83	49.40%
<b>Construction Factors Group</b>				
23	Effective subcontractor selection procedure by the Project Company	HI	93	55.36%
24	Well defined construction period	HI	89	52.98%
25	Consistent and effective project performance monitoring	HI	104	61.90%
26	Effective safety management plan during construction and operation phase	HI	85	50.60%
27	Effective quality management plan during construction and operation phase	HI	95	56.55%
<b>Operation Factors Group</b>				
28	Effective management of operational problems during operation by the Project Company	HI	99	58.93%
29	Effective change management system in the operational contract agreements by the stakeholders	HI	94	55.95%
30	Well defined operation (concession) period	HI	100	59.52%
31	Long term demand for the project post-event	HI	85	50.60%
32	Consideration of sustainability in operation while maintaining service levels	HI	101	60.12%
<b>Sports Factors Group</b>				
33	Suitability of the size of the sports facility for usage after the event	HI	82	48.81%
34	Adaptability for the conversion of the sports facility after the event	HI	88	52.38%
35	Availability of other sports facilities with similar functions	HI	76	45.24%

#### 4.5.2 Critical Success Factors Groups

This section will highlight and analyze the groups where the Critical Success Factors are considered part of the survey representing the respondents' thoughts in terms of importance but with the modified data after removing the outliers as follows:

Table 42. Summary of the group responses on the groups – Modified Data

Code/Response	NI	LI	MI	HI	EI					
Stakeholders related factors	0.00%	0	2.38%	4	17.26%	29	50.60%	85	29.76%	50
Risk related factors	0.00%	0	1.79%	3	20.24%	34	54.17%	91	23.81%	40
Finance related factors	0.00%	0	1.79%	3	15.48%	26	45.24%	76	37.50%	63



Code/Response	NI	LI	MI	HI	EI					
Legal related factors	0.00%	0	1.79%	3	17.86%	30	52.38%	88	27.98%	47
Design related factors	0.00%	0	0.60%	1	17.26%	29	50.60%	85	31.55%	53
Construction-related factors	0.00%	0	1.19%	2	17.26%	29	54.76%	92	26.79%	45
Operation related factors	0.00%	0	1.19%	2	19.05%	32	57.74%	97	22.02%	37
Sports Related factors	0.00%	0	4.76%	8	30.95%	52	47.62%	80	16.67%	28

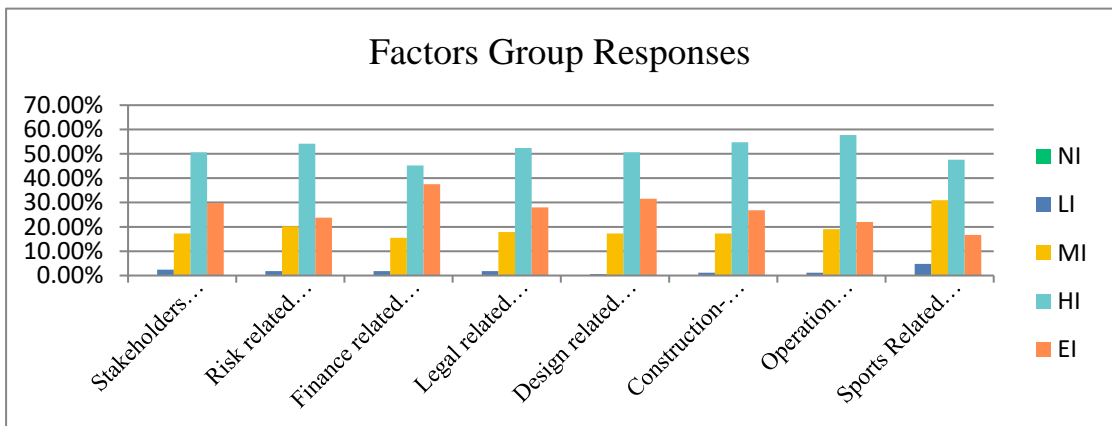

Figure 31. Summary of the group responses on the groups – Modified Data

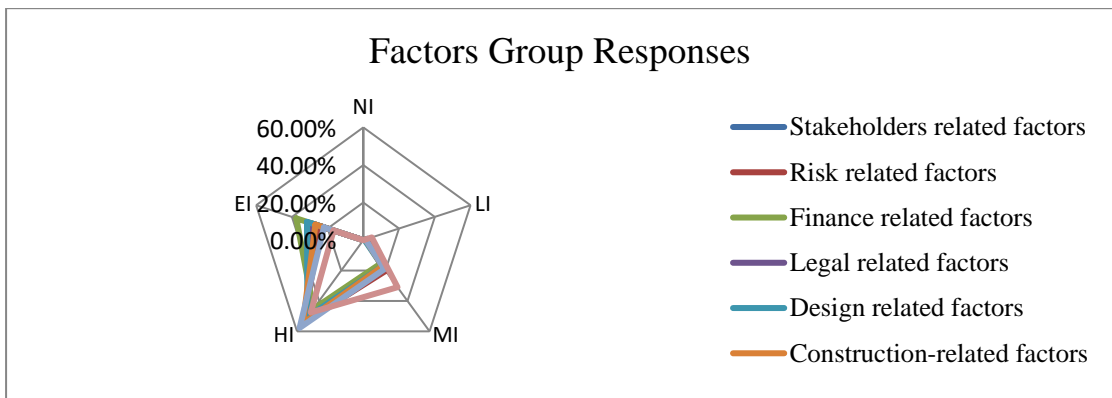

Figure 32. Summary of the group responses on the groups (Radar) – Modified Data

The results indicate that all the groups fall under the High Importance Category with 97 responses against 118 responses earlier (57.74% 55.14%), up to 97 responses against 118 responses earlier (57.74% 55.14%). Despite reducing the responses, the percentages have increased when comparing the first data set with the modified data.

### 4.5.3 Relative Importance Index (RII) – Modified Data

This section will examine the importance of the individual critical success factors and the critical success factors groups using the Relative Important Index using the modified data, which will be further validated using structural equation modelling.

This section will explain and illustrate the individual Critical Success Factors Ranking and the Critical Success Groups ranking.

Table 43 and 44 below calculate the RII and indicate the individual Critical Success Factors Ranking and the Critical Success Groups Ranking but using the modified data.

Table 43. Individual Critical Success Factors Ranking using RII – modified data

Factor	Likert Scale Point					N	Responses		RII	Rank
	NI	LI	MI	HI	EI		Min.	Max.		
L_2	1	1	14	70	82	168	1	5	0.87500	1
ST_4	1	0	22	77	68	168	1	5	0.85119	2
C_4	0	1	24	85	58	168	2	5	0.83810	3
ST_1	1	1	23	85	58	168	1	5	0.83571	4
C_5	0	1	21	95	51	168	2	5	0.83333	5
L_3	1	1	27	80	59	168	1	5	0.83214	6
R_3	1	4	21	88	54	168	1	5	0.82619	7
F_2	1	1	23	93	50	168	1	5	0.82619	8
R_4	1	0	29	85	53	168	1	5	0.82500	9
C_1	0	1	26	93	48	168	2	5	0.82381	10
C_3	0	2	19	104	43	168	2	5	0.82381	11
O_1	0	1	24	99	44	168	2	5	0.82143	12
L_1	1	1	31	82	53	168	1	5	0.82024	13
F_1	1	2	29	84	52	168	2	5	0.81905	14
D_3	0	2	30	91	45	168	2	5	0.81310	15
C_2	0	1	33	89	45	168	2	5	0.81190	16
L_4	1	1	35	86	45	168	1	5	0.80595	17
F_3	1	2	30	96	39	168	1	5	0.80238	18
R_2	1	3	42	74	48	168	1	5	0.79643	19
O_2	0	3	34	94	37	168	2	5	0.79643	20
O_3	0	1	34	100	33	168	2	5	0.79643	21
R_1	1	3	33	94	37	168	1	5	0.79405	22
D_4	0	2	47	83	36	168	2	5	0.78214	23
F_4	2	6	40	78	42	168	1	5	0.78095	24
D_1	1	3	49	76	39	168	1	5	0.77738	25
S_1	0	4	47	82	35	168	2	5	0.77619	26

Factor	Likert Scale Point					N	Responses		RII	Rank
	NI	LI	MI	HI	EI		Min.	Max.		
O_5	0	2	41	101	24	168	2	5	0.77500	27
O_4	0	3	49	85	31	168	2	5	0.77143	28
ST_3	1	8	45	82	32	168	1	5	0.76190	29
S_2	0	6	47	88	27	168	2	5	0.76190	30
D_2	0	5	54	78	31	168	2	5	0.76071	31
ST_2	2	8	44	83	31	168	1	5	0.75833	32
F_5	1	4	57	81	25	168	2	5	0.74881	33
ST_5	1	12	50	77	28	168	1	5	0.74167	34
S_3	3	8	69	76	12	168	1	5	0.70238	35

Table 44. Critical Success Factors Groups using RII – modified data

Code/Response	NI	LI	MI	HI	EI	N	Min.	Max.	RII	Rank
Finance related factors	0	3	26	76	63	168	2	5	0.83690	1
Design related factors	0	1	29	85	53	168	2	5	0.82619	2
Stakeholders related factors	0	4	29	85	50	168	2	5	0.81548	3
Construction-related factors	0	2	29	92	45	168	2	5	0.81429	4
Legal related factors	0	3	30	88	47	168	2	5	0.81310	5
Operation related factors	0	2	32	97	37	168	2	5	0.80119	6
Risk related factors	0	3	34	91	40	168	2	5	0.80000	7
Sports Related factors	0	8	52	80	28	168	2	5	0.75238	8

The results of the modified data have shown the following:

- For the individual critical success factors, 18 factors are highly important against 14 using the original data, while 17 factors are high-medium importance against 21 factors using the original data.
- For the critical success factor groups, seven groups are highly important against four groups using the original data. In comparison, only one group is high-medium importance against seven groups using the original data. The results indicate an alteration in the ranking resulted from the revised RII, as shown below.

Table 45. Comparison between RII and ranking between Original and modified data – Individual Factors

Factor	RII-M	Rank-M	RII-O	Rank-O
L_2	0.87500	1	0.87383	1
ST_4	0.85119	2	0.83645	2
C_4	0.83810	3	0.81589	6
ST_1	0.83571	4	0.82430	4
C_5	0.83333	5	0.80654	12
L_3	0.83214	6	0.82523	3
R_3	0.82619	7	0.81495	7
F_2	0.82619	8	0.82336	5
R_4	0.82500	9	0.80935	8
C_1	0.82381	10	0.80093	14
C_3	0.82381	11	0.80748	11
O_1	0.82143	12	0.80935	10
L_1	0.82024	13	0.80561	13
F_1	0.81905	14	0.80935	9
D_3	0.81310	15	0.79907	15
C_2	0.81190	16	0.79252	18
L_4	0.80595	17	0.79626	17
F_3	0.80238	18	0.79626	16
R_2	0.79643	19	0.77944	21
O_2	0.79643	20	0.77850	22
O_3	0.79643	21	0.78598	19
R_1	0.79405	22	0.78224	20
D_4	0.78214	23	0.76636	25
F_4	0.78095	24	0.77009	23
D_1	0.77738	25	0.77009	24
S_1	0.77619	26	0.76262	27
O_5	0.77500	27	0.75701	28
O_4	0.77143	28	0.76262	26
ST_3	0.76190	29	0.75234	29
S_2	0.76190	30	0.75140	30
D_2	0.76071	31	0.74299	33
ST_2	0.75833	32	0.74579	32
F_5	0.74881	33	0.74673	31
ST_5	0.74167	34	0.72243	34
S_3	0.70238	35	0.68224	35

Table 46. Comparison between RII and ranking between Original and modified data –

Groups

Code/Response	RII-M	Rank-M	RII-O	Rank-O
Finance related factors	0.83690	1	0.839252	1
Design related factors	0.82619	2	0.819626	2
Stakeholders related factors	0.81548	3	0.78972	6
Construction-related factors	0.81429	4	0.799065	5
Legal related factors	0.81310	5	0.802804	3
Operation related factors	0.80119	6	0.801869	4
Risk related factors	0.80000	7	0.785047	7
Sports Related factors	0.75238	8	0.735514	8

As a final step, the study will calculate the Average RII for each group based on the data obtained for the individual critical success factors and the critical success factors groups to determine the final ranking.

This average RII will be calculated using the Sum of RII per group and then calculating the average RII per group, which will indicate a new ranking. Table 47 below shows the Group ranking based on the individual Critical Success Factors.

Table 47. Group RII based on individual Critical Success Factors

Group	Factor	RII-M	Rank-M	Sum	Num.	Avg.	Rank
Legal	L1	0.82024	13	3.33333	4	0.83333	1
	L2	0.87500	1				
	L3	0.83214	6				
	L4	0.80595	17				
Construction	C1	0.82381	10	4.13095	5	0.82619	2
	C2	0.81190	16				
	C3	0.82381	11				
	C4	0.83810	3				
	C5	0.83333	5				
Risk	R1	0.79405	22	3.24167	4	0.81042	3
	R2	0.79643	19				
	R3	0.82619	7				
	R4	0.82500	9				

Finance	F1	0.81905	14	3.97738	5	0.79548	4
	F2	0.82619	8				
	F3	0.80238	18				
	F4	0.78095	24				
	F5	0.74881	33				
Operation	O1	0.82143	12	3.96071	5	0.79214	5
	O2	0.79643	20				
	O3	0.79643	21				
	O4	0.77143	28				
	O5	0.77500	27				
Stakeholder	ST1	0.83571	4	3.94881	5	0.78976	6
	ST2	0.75833	32				
	ST3	0.76190	29				
	ST4	0.85119	2				
	ST5	0.74167	34				
Design	D1	0.77738	25	3.13333	4	0.78333	7
	D2	0.76071	31				
	D3	0.81310	15				
	D4	0.78214	23				
Sports	S1	0.77619	26	2.24048	3	0.74683	8
	S2	0.76190	30				
	S3	0.70238	35				

The average RII per group calculated above will be added to the group RII obtained earlier to determine an average RII per group and final ranking, as shown in Table 48 below.

Table 48. Final ranking for groups based on average RII

Group	RII-G	Rank-G	RII-IG	Rank-IG	Avg. RII	Final Rank
Legal	0.81310	5	0.83333	1	0.82321	1
Construction	0.81429	4	0.82619	2	0.82024	2
Finance	0.83690	1	0.79548	4	0.81619	3
Risk	0.80000	7	0.81042	3	0.80521	4
Design	0.82619	2	0.78333	7	0.80476	5
Stakeholder	0.81548	3	0.78976	6	0.80262	6
Operation	0.80119	6	0.79214	5	0.79667	7
Sports	0.75238	8	0.74683	8	0.7496	8

The study will utilize the results of the modified data for the sake of validity.

#### 4.6 Advanced Statistical Analysis

In this section, a Statistical advance analysis will be done using the modified data (without outliers) for both the individual Critical Success Factor Model and the Critical Success Factors Groups, which will be the first time to use such a technique in a similar study.

This analysis's proposed software is SPSS AMOS 26. The analysis method is called Structural Equation Modelling - SEM (also called Analysis of Moment Structure – AMOS), a general data analysis approach (analysis of covariance structure).

The SEM is well known as a robust multivariate statistical technique that includes two types of models: a measurement model [(confirmatory factor analysis (CFA)], which confirm the reliability and validity, and a structural model (path analysis), which determine the relationship between the factors where SEM can model and analyze the variables of independent-dependent relationships by taking into consideration the measurement errors, exploring the relationships among multiple variables (Hair, Black, Babin, & Anderson, 2014).

The analysis will require a model to go through an individual process to reach the fit for purpose Structural Equation model at the last cycle. These steps are as follows:

- 1- Model Specification and building: identifying the latent variable, observed variables, errors, unidirectional relations and covariance between variables.
- 2- Model Estimation: this step is basically to load the data over the model and run it to obtain numerical results.
- 3- Model Testing: in this step, the numerical data obtained under the Model Estimation step against the threshold to check the model fitness. The testing

would be done on the following parameters:

- a. Model Testing Statistics: Relative Chi-Square, also called parsimonious fit ranging between 1.0 and 3.0, is deemed to be acceptable.
- b. Goodness Fit Indices
  - i. The Comparative Fit Index (CFI): The value of CFI is ranging between 0 to 1. CFI value higher than 0.9 deemed to be acceptable.
- c. Badness Fit Indices
  - i. Standardized Root Mean Square Residual (SRMR): The value of SMRM shall be lesser than 0.08 to be deemed acceptable.
  - ii. Root Mean Square Error of Approximate (RMSEA): The value of RMSEA ranging between 0.05 and 0.1. RMSEA value shall be lower than 0.08 to be deemed acceptable.
- d. PCLOSE: The value of PCLOSE shall be more than 0.05.

In contrast, Table 49 below indicates the factors that will be tested to determine the model fitness as follows:

Table 49. Model Fitness Parameters

No.	Indices	Measure	Threshold
1	Chi-Square	$\chi^2/df$	Between 1 and 3
2	The Comparative Fit Index	CFI	$\geq 0.9$
3	Standardized Root Mean Square Residual	SRMR	$< 0.08$
4	Root Mean Square Error of Approximate	RMSEA	$< 0.08$
5	PCLOSE Test	PCLOSE	$\geq 0.05$

#### 4- Model Modification:

Three models will be built for each survey (Individual and Group Critical Success Factors) as follows:



- 1- Proposed model: will cover Model specification and building and Model estimation.
- 2- Modified model: will cover Model Testing and Model Modification to fit the purpose model matching the fitness criteria listed in Table 49.
- 3- Structural Equation Model: this model will be the final model (2<sup>nd</sup> degree Model) based on the previous steps' modifications.
- 4- Final testing

#### *4.6.1 Proposed Model Analysis*

##### *4.6.1.1 Individual Critical Success Factors*

The proposed model will be built using the modified data with the boot-strap feature to address any non-normality issue; then, it will examine the fitness criteria described above.

The proposed model will compose of eight latent variables and 35 observed variables. Figure 33 below will show the proposed model.

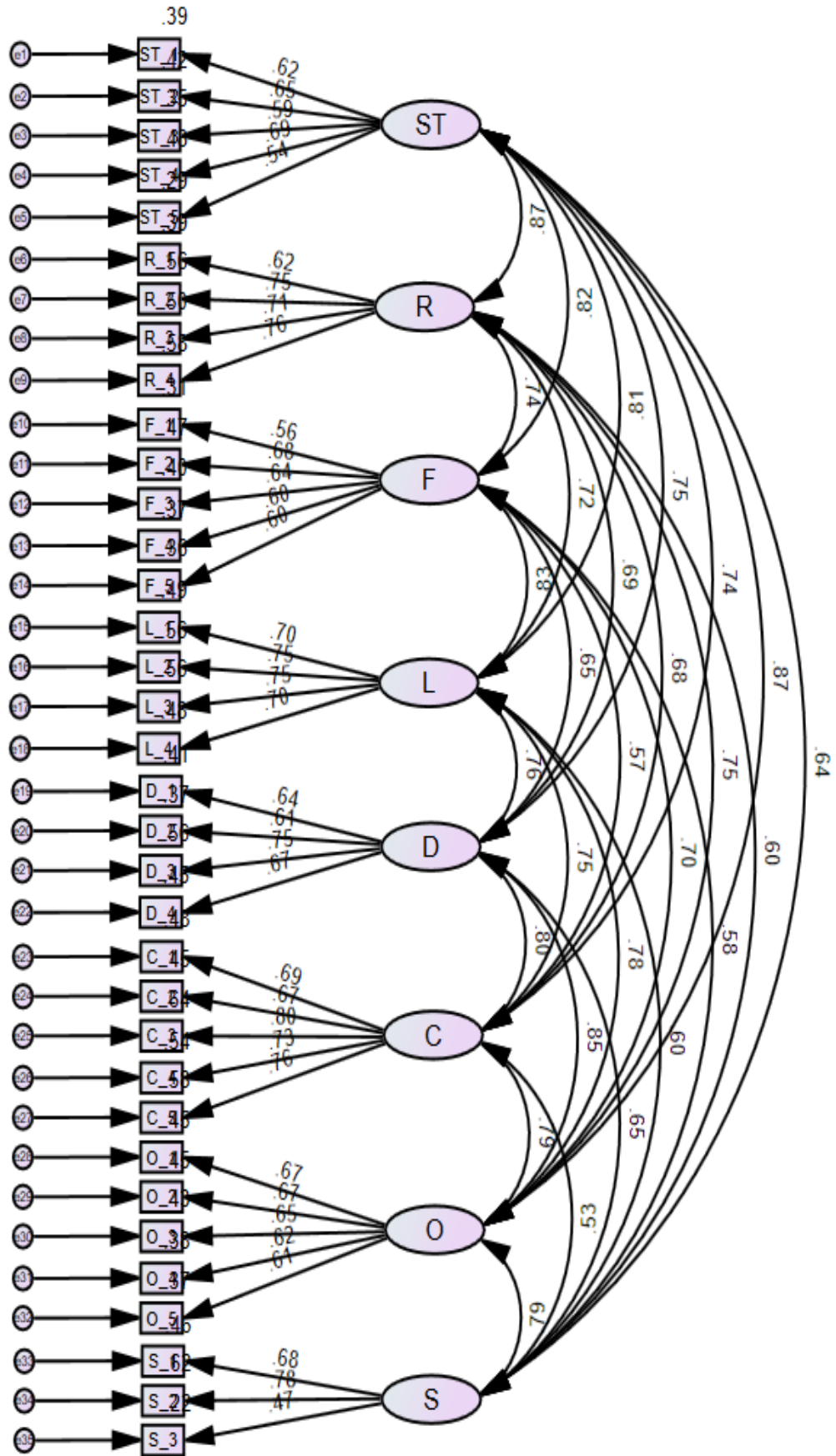

Figure 33. Proposed Model – Individual Critical Success Factors

Table 50. below explains the model fitness parameters and results of the first run.

Table 50. Proposed model fitness - individual Critical Success Factors

No.	Indices	Measure	Threshold	Result	Status
1	Chi-Square	$\chi^2/df$	Between 1 and 3	1.802	OK
2	The Comparative Fit Index	CFI	$\geq 0.9$	0.84	Not OK
3	Standardized Root Mean Square Residual	SRMR	$< 0.08$	0.0597	OK
4	Root Mean Square Error of Approximate	RMSEA	$< 0.08$	0.069	OK
5	PCLOSE Test	PCLOSE	$\geq 0.05$	0.001	Not Ok

The results obtained illustrate the model is not fit. This will lead to modifying the model and making it fit as per the above parameters.

Table 51. The covariances obtained for the proposed model will be used as a reference to build the modified model.

Table 51. Covariances - individual Critical Success Factors

Covariances		M.I.	Par Change	
e30	<-->	e32	4.535	0.045
e28	<-->	C	5.99	0.031
e28	<-->	e30	5.487	-0.046
e27	<-->	F	5.105	-0.027
e27	<-->	e28	4.289	0.037
e26	<-->	R	4.331	0.027
e26	<-->	e32	5.824	0.05
e26	<-->	e29	7.118	-0.057
e26	<-->	e27	10.753	0.057
e23	<-->	e32	7.403	-0.057
e23	<-->	e27	5.134	-0.04
e23	<-->	e24	4.36	0.044
e35	<-->	ST	6.026	0.042
e34	<-->	e24	8.136	-0.067
e34	<-->	e1	7.338	-0.069
e33	<-->	e24	5.541	0.06
e33	<-->	e1	7.736	0.077
e22	<-->	e32	9.231	0.072
e22	<-->	e28	8.805	-0.066
e22	<-->	e25	6	-0.047
e22	<-->	e34	8.192	0.071
e21	<-->	e32	6.23	-0.052
e21	<-->	e27	4.684	0.039

Covariances		M.I.	Par Change	
e21	<-->	e26	5.999	-0.049
e20	<-->	e31	4.2	-0.06
e19	<-->	e21	4.767	-0.055
e18	<-->	C	7.135	-0.038
e18	<-->	e26	4.789	0.048
e18	<-->	e24	5.526	-0.056
e18	<-->	e23	4.094	-0.045
e18	<-->	e19	5.473	0.066
e17	<-->	C	6.481	0.035
e17	<-->	ST	4.375	-0.028
e17	<-->	e24	4.18	0.046
e17	<-->	e23	8.917	0.064
e17	<-->	e1	4.718	-0.054
e16	<-->	e1	6.453	0.06
e16	<-->	e22	7.188	-0.062
e16	<-->	e17	8.822	0.063
e15	<-->	S	4.733	0.045
e15	<-->	e29	5.025	-0.054
e15	<-->	e28	5.427	0.052
e15	<-->	e33	5.032	0.061
e15	<-->	e17	4.309	-0.049
e13	<-->	e30	5.215	0.065
e13	<-->	e14	17.651	0.146
e13	<-->	e1	6.318	-0.082
e12	<-->	ST	6.503	0.036
e12	<-->	e1	5.257	0.061
e12	<-->	e13	6.37	-0.081
e11	<-->	e22	9.619	-0.076
e10	<-->	R	6.456	0.043
e10	<-->	e27	5.175	-0.052
e9	<-->	e27	12.523	0.065
e9	<-->	e26	8.568	0.059
e9	<-->	e1	5.181	-0.054
e9	<-->	e20	4.399	-0.054
e8	<-->	e12	5.574	-0.062
e8	<-->	e10	6.106	0.072
e7	<-->	F	6.326	-0.039
e7	<-->	e14	5.048	-0.065
e7	<-->	e33	4.688	-0.061
e7	<-->	e13	5.204	-0.075
e7	<-->	e8	12.45	0.092
e6	<-->	R	4.892	-0.034
e6	<-->	ST	4.209	0.03
e6	<-->	e12	5.86	0.066
e6	<-->	e8	10.323	-0.086
e5	<-->	ST	4.408	-0.036
e5	<-->	e1	7.772	-0.093
e5	<-->	e34	4.768	0.069
e5	<-->	e33	4.723	-0.075
e5	<-->	e19	4.318	0.076
e5	<-->	e15	4.04	-0.065

Covariances			M.I.	Par Change
e5	<-->	e6	9.882	0.107
e4	<-->	F	4.267	-0.029
e4	<-->	e32	6.066	-0.056
e4	<-->	e29	10.187	0.074
e4	<-->	e28	6.11	0.053
e4	<-->	e27	8.001	0.055
e4	<-->	e12	4.297	0.052
e4	<-->	e10	7.594	-0.076
e4	<-->	e9	4.298	0.046
e4	<-->	e8	8.122	-0.07
e4	<-->	e5	6.183	0.077
e3	<-->	e29	5.237	0.066
e3	<-->	e28	4.917	-0.058
e3	<-->	e19	6.245	0.085
e2	<-->	e1	11.565	0.102
e2	<-->	e19	6.839	-0.087
e2	<-->	e15	4.211	0.06
e2	<-->	e7	5.781	-0.073
e2	<-->	e5	11.366	-0.127

#### 4.6.1.2 Critical Success Factors Groups

The proposed model will be built using the modified data with the boot-strap feature to address any non-normality issue. There was no reported non-normality in the responses obtained; then, it will examine the fitness criteria described above.

The proposed model will compose of one latent variable and eight observed variables.

Figure 34 below will show the proposed model. This model is an extraction of the second-order degree data for validation purposes.

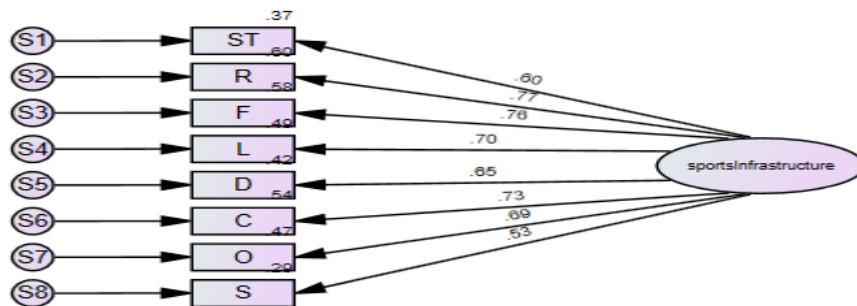

Figure 34. Proposed Model – Group Critical Success Factors

Table 52. below will explain the model fitness parameters and results obtained from the first run.

Table 52. Proposed model fitness - Group Critical Success Factors

No.	Indices	Measure	Threshold	Result	Status
1	Chi-Square	$\chi^2/df$	Between 1 and 3	5.27	Not OK
2	The Comparative Fit Index	CFI	$\geq 0.9$	0.854	Not OK
3	Standardized Root Mean Square Residual	SRMR	$< 0.08$	0.0696	OK
4	Root Mean Square Error of Approximate	RMSEA	$< 0.08$	0.16	Not OK
5	PCLOSE Test	PCLOSE	$\geq 0.05$	000	Not OK

The results obtained illustrate the model is not fit. This will lead to modifying the model and making it fit as per the above parameters.

Table 53. The covariances obtained for the proposed model will be used as a reference to build the modified model to determine the relationship between latent variables.

Table 53. Covariances - Group Critical Success Factors

Covariances			M.I.	Par Change
S3	<-->	S2	5.686	0.048
S4	<-->	S3	6.303	0.056
S5	<-->	S1	6.206	-0.066
S5	<-->	S3	7.409	-0.062
S6	<-->	S3	9.912	-0.065
S6	<-->	S4	8.244	-0.062
S6	<-->	S5	47.379	0.15
S7	<-->	S1	7.182	-0.066
S8	<-->	S2	6.224	-0.065
S8	<-->	S7	8.897	0.081

#### 4.6.2 Modified Model Analysis (1st Order Degree)

##### 4.6.2.1 Individual Critical Success Factors

Figure 35. below is the modified model that achieved the fitness criteria, as explained above.

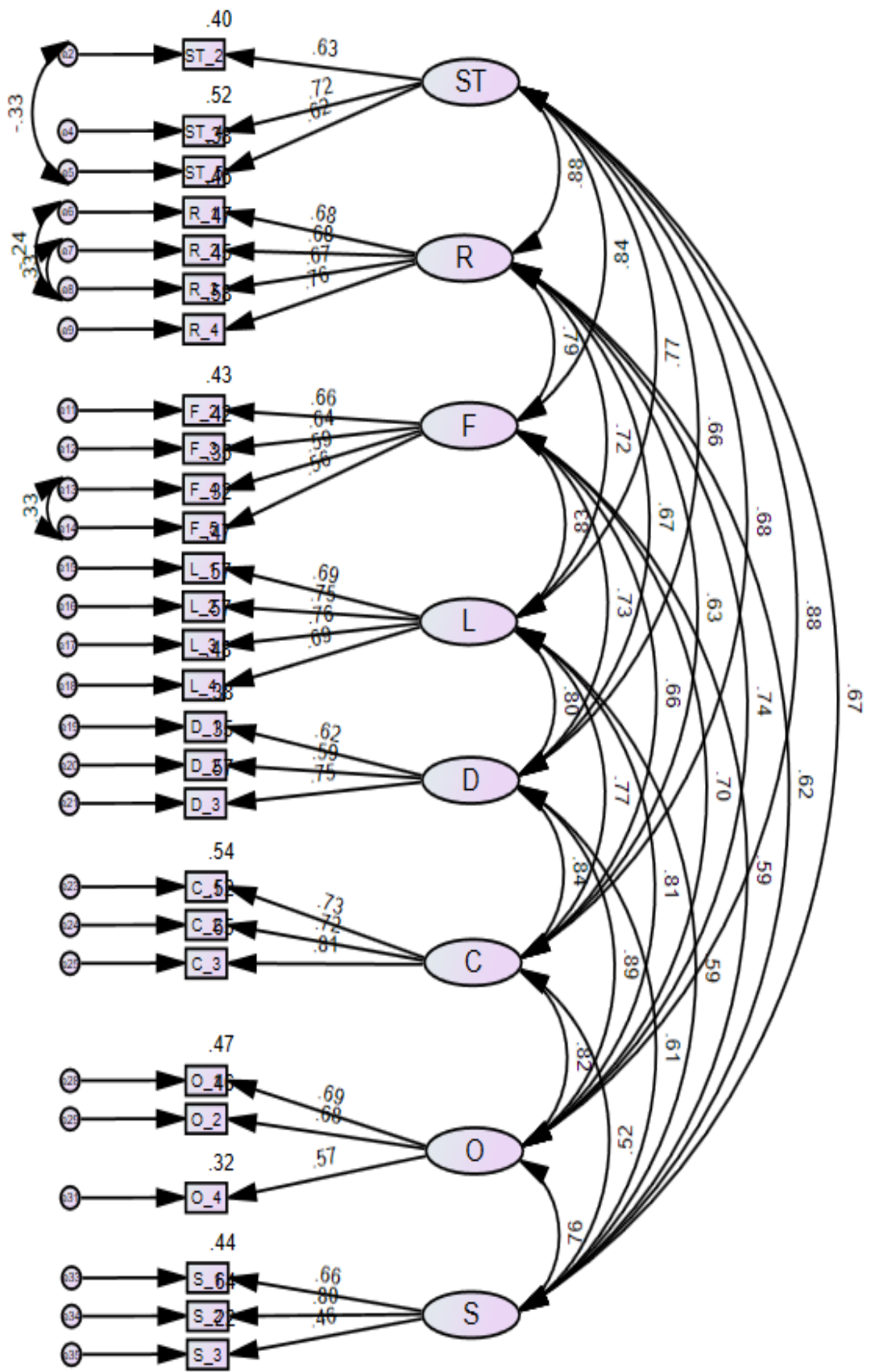

Figure 35. Modified Model – Individual Critical Success Factors

Table 54. Modified model fitness - Individual Critical Success Factors

No.	Indices	Measure	Threshold	Result	Status
1	Chi-Square	$\chi^2/df$	Between 1 and 3	1.405	OK
2	The Comparative Fit Index	CFI	$\geq 0.9$	0.936	Ok
3	Standardized Root Mean Square Residual	SRMR	$< 0.08$	0.0525	OK
4	Root Mean Square Error of Approximate	RMSEA	$< 0.08$	0.049	OK
5	PCLOSE Test	PCLOSE	$\geq 0.05$	0.097	Ok

Also, there were no observed variables with a weight less than 0.4; hence no variables were deleted in this model.

#### Assessment of Normality

Table 55 below will assess the Normality of the univariate and multivariate after bootstrap.

Table 55. Assessment of Modified Model Normality – Individual Critical Success Factors

Variable	min	max	skew	c.r.	kurtosis	c.r.
ST_2	1	5	-0.567	-3.003	0.485	1.284
ST_4	1	5	-0.807	-4.27	1.086	2.872
ST_5	1	5	-0.344	-1.821	-0.151	-0.399
R_1	1	5	-0.582	-3.08	0.946	2.504
R_2	1	5	-0.433	-2.292	-0.052	-0.137
R_3	1	5	-0.874	-4.624	1.342	3.55
R_4	1	5	-0.569	-3.011	0.719	1.903
F_2	1	5	-0.702	-3.714	1.447	3.829
F_3	1	5	-0.603	-3.189	1.175	3.108
F_4	1	5	-0.62	-3.282	0.456	1.207
F_5	1	5	-0.199	-1.055	0.167	0.443
L_1	1	5	-0.587	-3.105	0.556	1.472
L_2	1	5	-1.181	-6.252	2.198	5.814
L_3	1	5	-0.694	-3.674	0.749	1.98
L_4	1	5	-0.482	-2.552	0.517	1.367
D_1	1	5	-0.288	-1.522	-0.091	-0.241
D_2	2	5	-0.049	-0.258	-0.593	-1.569
D_3	2	5	-0.299	-1.581	-0.285	-0.755
C_1	2	5	-0.262	-1.386	-0.36	-0.952
C_2	2	5	-0.187	-0.987	-0.597	-1.58



Variable	min	max	skew	c.r.	kurtosis	c.r.
C_3	2	5	-0.383	-2.027	0.529	1.399
O_1	2	5	-0.237	-1.255	-0.134	-0.356
O_2	2	5	-0.284	-1.503	-0.127	-0.336
O_4	2	5	-0.055	-0.292	-0.536	-1.418
S_1	2	5	-0.133	-0.702	-0.551	-1.458
S_2	2	5	-0.211	-1.115	-0.238	-0.63
S_3	1	5	-0.468	-2.475	0.851	2.252

The bootstrap was applied for 2000 numbers of samples, and the results are as below:

- The model fit better in 1806 boot-strap samples.
- It fit about equally well in 0 boot-strap samples.
- It fit worse or failed to fit in 194 boot-strap samples.
- Testing the null hypothesis that the model is correct, Bollen-Stine boot-strap p = .097
- The Bollen-Stine value obtained equal to 0.097, which is an outstanding achievement. Figure 36 below shows the Boot-strap distribution.

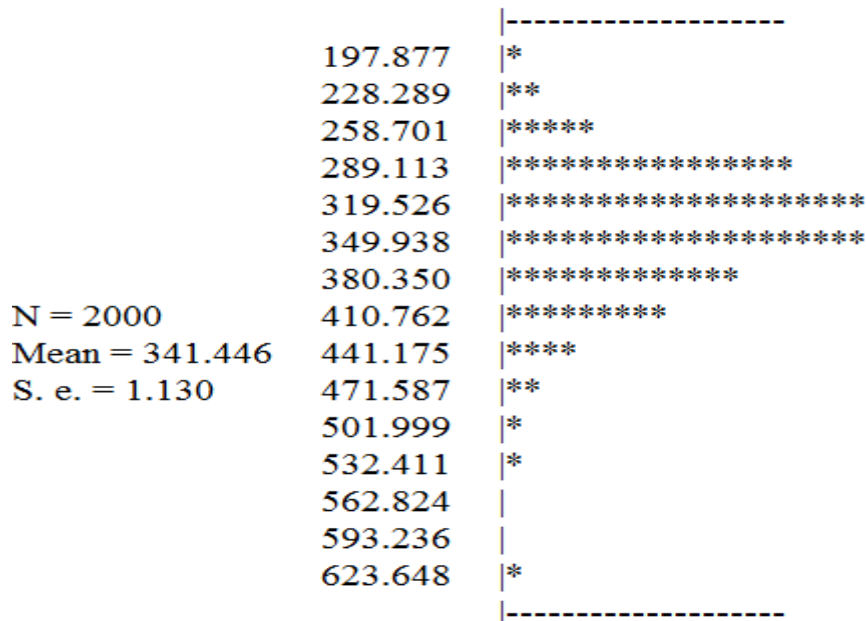

Figure 36. The Modified Model Bootstrap Distribution - Individual Critical Success Factors

#### 4.6.2.2 Critical Success Factors Groups

Figure 37 below shows the modified model that achieved the fitness criteria, as explained above.

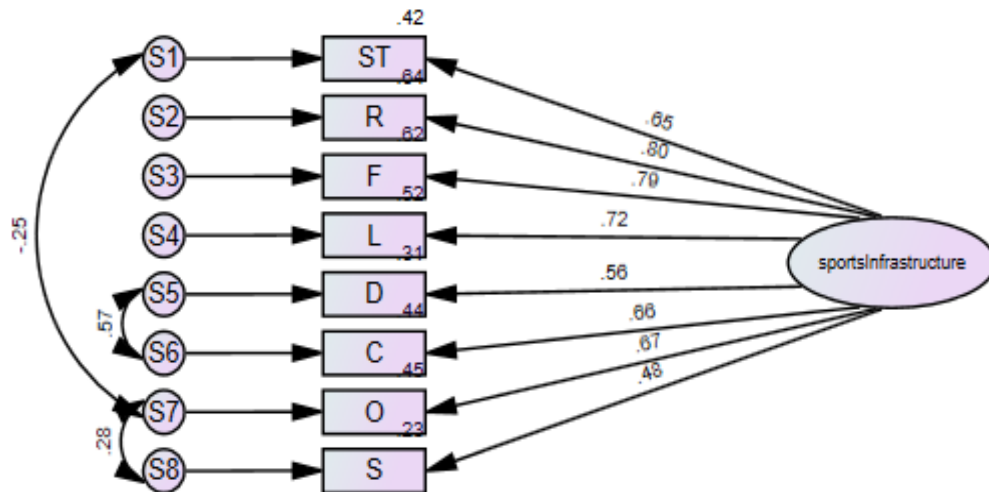

Figure 37. Modified Model – Group Critical Success Factors

Table 56. Modified model fitness - Group Critical Success Factors

No.	Indices	Measure	Threshold	Result	Status
1	Chi-Square	$\chi^2/df$	Between 1 and 3	1.81	OK
2	The Comparative Fit Index	CFI	$\geq 0.9$	0.976	Ok
3	Standardized Root Mean Square Residual	SRMR	$< 0.08$	0.0444	OK
4	Root Mean Square Error of Approximate	RMSEA	$< 0.08$	0.07	OK
5	PCLOSE Test	PCLOSE	$\geq 0.05$	0.209	Ok

Also, there were no observed variables with a weight less than 0.4; hence no variables were deleted in this model.

#### Assessment for Normality

Table 57 below will assess the Normality of the univariate and multivariate after bootstrap.

Table 57. Assessment of Normality – Critical Success Factors Groups

Group	min	max	skew	c.r.	kurtosis	c.r.
Stakeholders	2	5	-0.468	-2.476	-0.151	-0.401
Risk	2	5	-0.293	-1.548	-0.229	-0.605
Finance	2	5	-0.569	-3.009	-0.271	-0.718
Legal	2	5	-0.381	-2.017	-0.217	-0.573
Design	2	5	-0.291	-1.541	-0.609	-1.612
Construction	2	5	-0.309	-1.637	-0.232	-0.613
Operation	2	5	-0.237	-1.256	-0.13	-0.343
Sports	2	5	-0.157	-0.829	-0.43	-1.137

The bootstrap was applied for 2000 numbers of samples, and the results are as below:

- The model fit better in 1582 boot-strap samples.
- It fit about equally well in 0 boot-strap samples.
- It fit worse or failed to fit in 418 boot-strap samples.
- Testing the null hypothesis that the model is correct, Bollen-Stine boot-strap p = .209

The Bollen-Stine value obtained equal to 0.209, which is an outstanding achievement.

Figure 38 below shows the Boot-strap distribution.

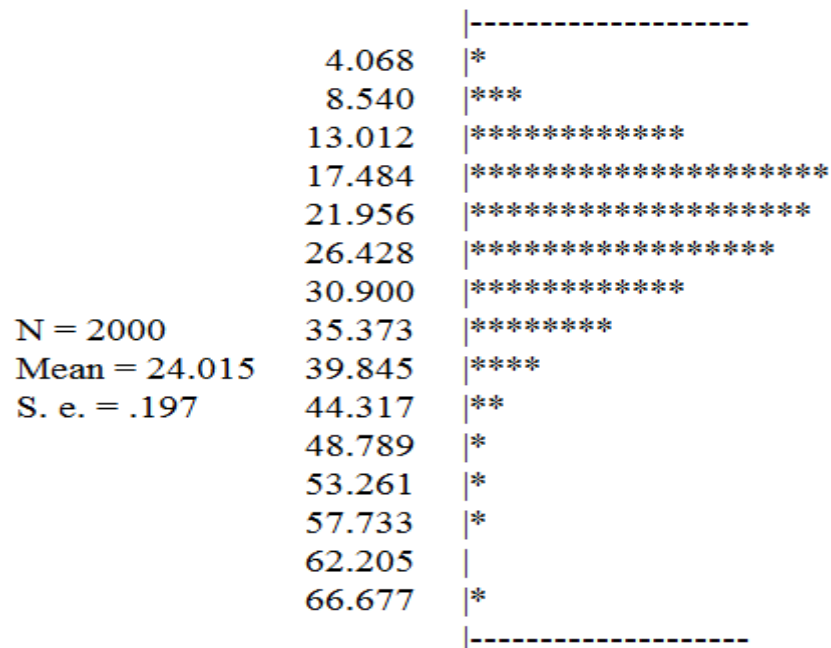

Figure 38. The Modified Model Bootstrap Distribution - Critical Success Factors Groups

### 4.6.3 Structural Equation Model (2<sup>nd</sup> Order Degree)

In this section, the final SEM will be built, tested for fitness, validity, and reliability.

The validity of the model is tested by using two tests which are convergent validity and discriminant validity.

The convergent validity measures how close the indicators to each other by calculating the average variance extracted (AVE), and the result should be more than 0.4.

Discriminant validity measures how Far the constructs to each other by calculating the square root of AVE, and the result should be greater than the latent variable correlation.

#### **Convergent Validity**

$$AVE = \sum Li^2/n \quad (i = 1 \text{ to } n)$$

Where:  $Li$  = standardized loading factor

$i$  = number of items

$n$  = total no of items

#### **Discriminant Validity**

The square root of AVE should be more than the latent variable correlation.

The Composite Reliability Test (CR)

Calculate the composite reliability as:

$$CR = (\sum \text{Standardized Loading})^2 / [(\sum \text{Standardized Loading})^2 + \sum(\text{Measurement Error})]$$

Where: Measurement Error =  $1 - (\text{Standardized Loading})^2$

The composite reliability ranges above 0.7, considered being a good achievement representing a reliable model.

5.6.3.1 Individual Critical Success Factors

Figure 39. below is the final model that achieved the fitness criteria

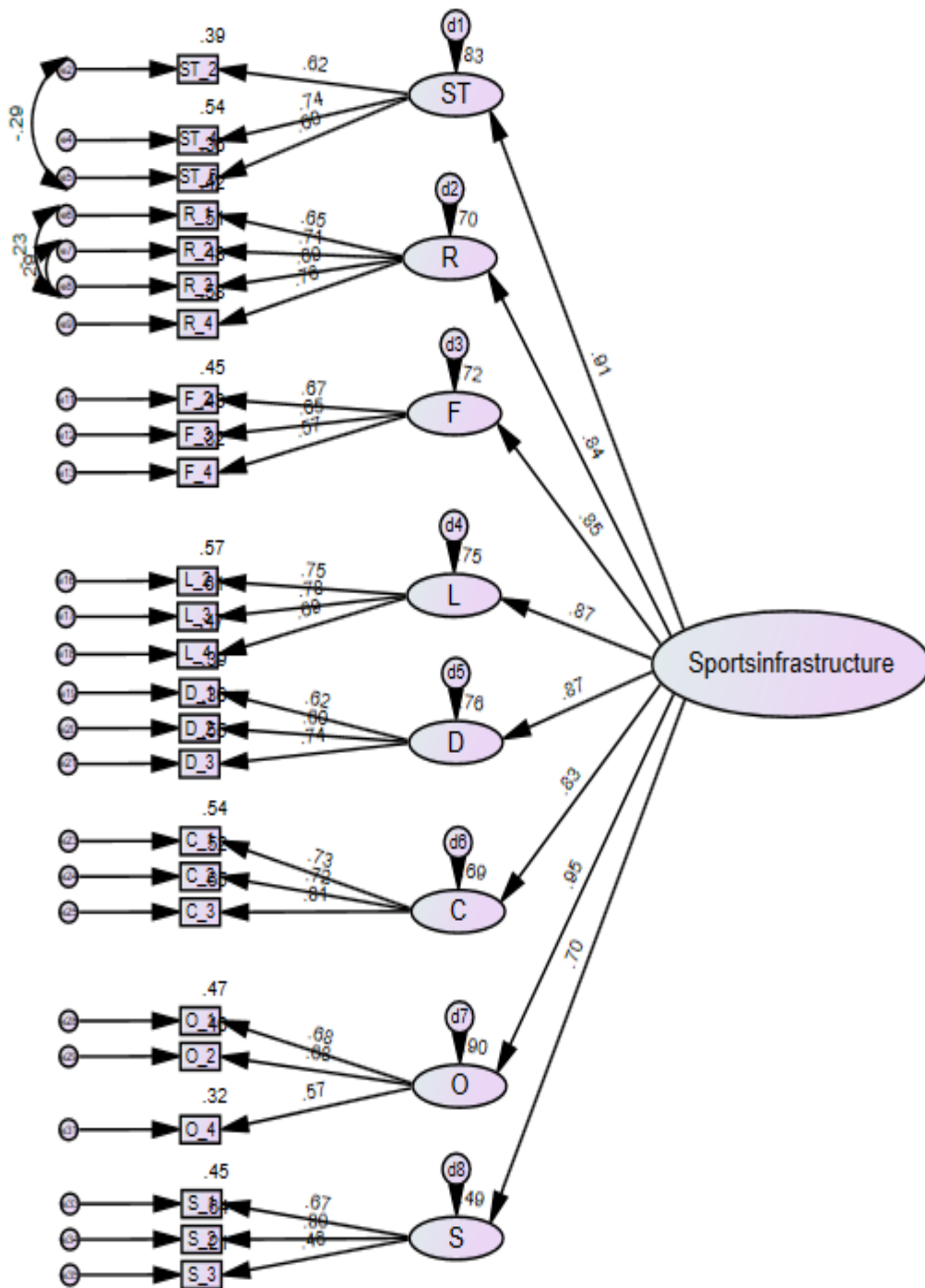

Figure 39. Final Model – Individual Critical Success Factors

Table 58. Final model fitness - Individual Critical Success Factors

No.	Indices	Measure	Threshold	Result	Status
1	Chi-Square	$\chi^2/df$	Between 1 and 3	1.439	OK
2	The Comparative Fit Index	CFI	$\geq 0.9$	0.930	Ok
3	Standardized Root Mean Square Residual	SRMR	$< 0.08$	0.0573	OK
4	Root Mean Square Error of Approximate	RMSEA	$< 0.08$	0.051	OK
5	PCLOSE Test	PCLOSE	$\geq 0.05$	0.073	Ok

Also, there were no observed variables with a weight less than 0.4; hence no variables were deleted in this model.

### Assessment of Normality

Table 59 assesses the Normality of the univariant and multivariate after bootstrap.

Table 59. Assessment of Final Model Normality – Individual Critical Success Factors

Variable	min	max	skew	c.r.	kurtosis	c.r.
O_4	2	5	-0.055	-0.292	-0.536	-1.418
O_2	2	5	-0.284	-1.503	-0.127	-0.336
O_1	2	5	-0.237	-1.255	-0.134	-0.356
C_3	2	5	-0.383	-2.027	0.529	1.399
C_2	2	5	-0.187	-0.987	-0.597	-1.58
C_1	2	5	-0.262	-1.386	-0.36	-0.952
S_3	1	5	-0.468	-2.475	0.851	2.252
S_2	2	5	-0.211	-1.115	-0.238	-0.63
S_1	2	5	-0.133	-0.702	-0.551	-1.458
D_3	2	5	-0.299	-1.581	-0.285	-0.755
D_2	2	5	-0.049	-0.258	-0.593	-1.569
D_1	1	5	-0.288	-1.522	-0.091	-0.241
L_4	1	5	-0.482	-2.552	0.517	1.367
L_3	1	5	-0.694	-3.674	0.749	1.98
L_2	1	5	-1.181	-6.252	2.198	5.814
F_4	1	5	-0.62	-3.282	0.456	1.207
F_3	1	5	-0.603	-3.189	1.175	3.108
F_2	1	5	-0.702	-3.714	1.447	3.829
R_4	1	5	-0.569	-3.011	0.719	1.903
R_3	1	5	-0.874	-4.624	1.342	3.55
R_2	1	5	-0.433	-2.292	-0.052	-0.137
R_1	1	5	-0.582	-3.08	0.946	2.504
ST_5	1	5	-0.344	-1.821	-0.151	-0.399
ST_4	1	5	-0.807	-4.27	1.086	2.872
ST_2	1	5	-0.567	-3.003	0.485	1.284

The bootstrap was applied for 2000 numbers of samples, and the results are as below:

- The model fit better in 1854 boot-strap samples.
- It fit about equally well in 0 boot-strap samples.
- It fit worse or failed to fit in 146 boot-strap samples.
- Testing the null hypothesis that the model is correct, Bollen-Stine boot-strap p = .073
- The Bollen-Stine value obtained equal to 0.073, which is an outstanding achievement. Figure 40 below shows the Boot-strap distribution.

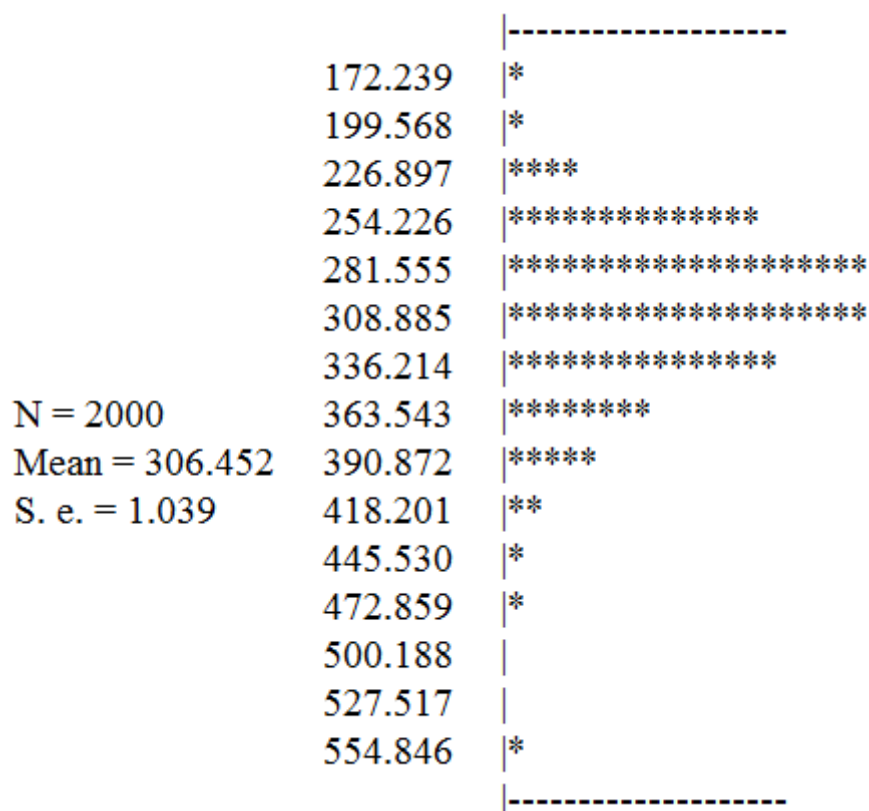

Figure 40. The Final Model Bootstrap Distribution - Individual Critical Success Factors

Table 60 below shows the validity tests values where the AVE is 0.731, above 0.5, as it was suggested that where AVE values are greater than .5, it is considered adequate. For composite reliabilities, values greater than about .6 are desirable (Bagozzi & Yi, 1988).

The CR value is 0.956, which is an excellent achievement; hence, we conclude that the model is valid and reliable.

Table 60. Final Model CR, AVE (reliability and validity estimates) - Individual Critical Success Factors

Factor	CR	AVE	MSV	Max R(H)	Sports infrastructure
Sports infrastructure	0.956	0.731	0	0.966	<b>0.855</b>

#### 4.6.3.2 Critical Success Factors Groups

This section is not applicable as there is no 2<sup>nd</sup> order degree variable; hence, the modified model is considered the Structural Equation Model. The ranks will be extracted from it accordingly.

Table 61 below shows the validity tests values where the AVE is 0.454, which is slightly less than 0.5; however, Malhotra N. K., Dash S. argue that AVE is often too strict, and reliability can be established through CR alone.

Table 61. The validity Test - Critical Success Factors Groups

Observed	Latent	Estimate	Estimate <sup>2</sup>	Sum	# of Indicators	AVE	Square
Stakeholders	<--- Sports Infrastructure	0.646	0.417				
Risk	<--- Sports Infrastructure	0.798	0.637				
Finance	<--- Sports Infrastructure	0.790	0.624				
Legal	<--- Sports Infrastructure	0.721	0.520				
Design	<--- Sports Infrastructure	0.558	0.311	3.629	8	0.454	0.673
Construction	<--- Sports Infrastructure	0.660	0.436				
Operation	<--- Sports Infrastructure	0.671	0.450				
Sports	<--- Sports Infrastructure	0.483	0.233				

Table 62 below shows the latent variable correlation, where the square root of AVE is higher than the correlation; hence, the model is acceptable.



Table 62. Correlation value between latent Variable - Critical Success Factors Groups

Factor		Factor	Estimate
Construction-related factors	<-->	Design related factors	0.57
Sports-Related Factors	<-->	Operation related factors	0.282
Operation related factors	<-->	Stakeholders related factors	-0.249

Table 63 below shows the Composite reliability value as 0.87, which is greater than 0.7; accordingly, we conclude the model is reliable.

Table 63. The reliability Test - Critical Success Factors Groups

Observed		Latent	Estimate	Std. Error	[Sum (Est)] ^2	CR	Threshold	Status
Stakeholders	<---	Sports Infrastructure	0.646	0.583				
Risk	<---	Sports Infrastructure	0.798	0.363				
Finance	<---	Sports Infrastructure	0.790	0.376				
Legal	<---	Sports Infrastructure	0.721	0.480				
Design	<---	Sports Infrastructure	0.558	0.689	28.376929	0.87	> 0.7	OK
Construction	<---	Sports Infrastructure	0.660	0.564				
Operation	<---	Sports Infrastructure	0.671	0.550				
Sports	<---	Sports Infrastructure	0.483	0.767				

#### 4.6.4 SEM Ranking

In this section, the study will calculate the effective weight of the constructs (groups) and the indicators to rank them. This will be completed twice for the individual Critical Success Factors (constructs and indicators) and only once for the second model as the groups are the indicators using the following formula:

$$EWC_i = SFLCI_i / \sum SFLCI_i$$

Where  $SFLCI$  = Standardized factor load of the construct

$\sum SFLCI$  = Sum of standardized factor load of the constructs

The last step in this section is to calculate the overall effective weight of the indicator (OEWi) as:

$$OEWi = EWi \times EWCi$$

Where:  $EWi$  = effect weight for each indicator within the construct

$EWCi$  = effect weight of construct

#### 4.6.4.1 Individual Critical Success Factors

Table 64 below shows the effect of weight and ranking among the groups.

Table 64. Effective weight and ranking between the constructs (groups)

Observed	SFL (A)	$\sum$ SFL (B)	EWCi C=(A/B)	Rank
Operation related factors	0.951	6.819	0.1395	1
Stakeholders related factors	0.909		0.1333	2
Design related factors	0.873		0.1280	3
Legal related factors	0.865		0.1269	4
Finance related factors	0.849		0.1245	5
Risk related factors	0.838		0.1229	6
Construction-related factors	0.831		0.1219	7
Sports-related Factors	0.703		0.1031	8

Table 65. Effective weight and ranking among constructs between the latent variables (Critical Success factors)

Observed	SFL (A)	$\sum$ SFL (B)	EWCi C=(A/B)	Rank
ST_4	0.736	1.96	0.3755	1
ST_2	0.621		0.3168	2
ST_5	0.603		0.3077	3
R_4	0.759	2.812	0.2699	1
R_2	0.713		0.2536	2
R_3	0.69		0.2454	3
R_1	0.65		0.2312	4
F_2	0.669	1.889	0.3542	1
F_3	0.654		0.3462	2
F_4	0.566		0.2996	3

Observed	SFL (A)	$\Sigma$ SFL (B)	EWCi	Rank
			C=(A/B)	
D_3	0.744		0.3786	1
D_1	0.622	1.965	0.3165	2
D_2	0.599		0.3048	3
C_3	0.807		0.3574	1
C_1	0.731	2.258	0.3237	2
C_2	0.72		0.3189	3
O_1	0.683		0.3539	1
O_2	0.678	1.93	0.3513	2
O_4	0.569		0.2948	3
S_2	0.798		0.4141	1
S_1	0.669	1.927	0.3472	2
S_3	0.46		0.2387	3

Table 66. Overall Effective weight and ranking between the latent variables (Critical Success factors)

Observed	SFL (A)	$\Sigma$ SFL (B)	EWCi	EWCi	OEWi
			C=(A/B)	(Construct)	
ST_4	0.736		0.37551		0.050
ST_2	0.621	1.96	0.316837	0.133304	0.042
ST_5	0.603		0.307653		0.041
R_4	0.759		0.269915		0.033
R_2	0.713	2.812	0.253556	0.1228919	0.031
R_3	0.69		0.245377		0.030
R_1	0.65		0.231152		0.028
F_2	0.669		0.354156		0.044
F_3	0.654	1.889	0.346215	0.1245051	0.043
F_4	0.566		0.299629		0.037
L_3	0.781		0.351327		0.045
L_2	0.754	2.223	0.339181	0.1268514	0.043
L_4	0.688		0.309492		0.039
D_3	0.744		0.378626		0.048
D_1	0.622	1.965	0.316539	0.1280246	0.041
D_2	0.599		0.304835		0.039
C_3	0.807		0.357396		0.044
C_1	0.731	2.258	0.323738	0.1218654	0.039
C_2	0.72		0.318866		0.039
O_1	0.683		0.353886		0.049
O_2	0.678	1.93	0.351295	0.1394633	0.049
O_4	0.569		0.294819		0.041
S_2	0.798		0.414115		0.043
S_1	0.669	1.927	0.347172	0.1030943	0.036
S_3	0.46		0.238713		0.025

Table 67. latent variables (critical success factors) based on the overall effective weight

Factor	Observed	OEWi	Rank O
Open and constant communication among stakeholders	ST_4	0.0501	1
Effective management of operational problems during operation by the Project Company	O_1	0.0494	2
Effective change management system in the operational contract agreements by the stakeholders	O_2	0.0490	3
An effective design management plan	D_3	0.0485	4
Well defined bidding process for the project	L_3	0.0446	5
An effective payment mechanism to the Project Company during the operation stage	F_2	0.0441	6
Consistent and effective project performance monitoring	C_3	0.0436	7
An effective life cycle cost analysis for the project by the project stakeholders	F_3	0.0431	8
Well written contract document protecting all project stakeholders	L_2	0.0430	9
Adaptability for the conversion of the sports facility after the event	S_2	0.0427	10
Realistic sharing of income by stakeholders	ST_2	0.0422	11
Long term demand for the project post-event	O_4	0.0411	12
Compatibility skills among stakeholders	ST_5	0.0410	13
Proper assessment of the environmental impact of the project	D_1	0.0405	14
Effective subcontractor selection procedure by the Project Company	C_1	0.0395	15
Availability of Government legislation and policies that support PPP initiatives	L_4	0.0393	16
Utilization of innovational design technology (such as BIM-Building Information Modelling)	D_2	0.0390	17
Well defined construction period	C_2	0.0389	18
Government providing guarantees for the rate of return	F_4	0.0373	19
Suitability of the size of the sports facility for usage after the event	S_1	0.0358	20
Effective operational risk management during the construction and operation stage	R_4	0.0332	21
Timely securing of necessary access permits	R_2	0.0312	22
Timely access to the project site by Project Company	R_3	0.0302	23
Appropriate risk allocation and sharing among stakeholders	R_1	0.0284	24
Availability of other sports facilities with similar functions	S_3	0.0246	25

Table 68. Overall Effective Weight for All Indicators

Construct	Observed	EWCi	EWCi (Construct)	OEWi
ST	ST_4	0.37551	0.133304	0.050
	ST_2	0.316837		0.042
	ST_5	0.307653		0.041
R	R_4	0.269915	0.1228919	0.033
	R_2	0.253556		0.031
	R_3	0.245377		0.030
	R_1	0.231152		0.028

Construct	Observed	EWCi	EWCi	OEWi
			(Construct)	
F	F_2	0.354156	0.1245051	0.044
	F_3	0.346215		0.043
	F_4	0.299629		0.037
L	L_3	0.351327	0.1268514	0.045
	L_2	0.339181		0.043
	L_4	0.309492		0.039
D	D_3	0.378626	0.1280246	0.048
	D_1	0.316539		0.041
	D_2	0.304835		0.039
C	C_3	0.357396	0.1218654	0.044
	C_1	0.323738		0.039
	C_2	0.318866		0.039
O	O_1	0.353886	0.1394633	0.049
	O_2	0.351295		0.049
	O_4	0.294819		0.041
S	S_2	0.414115	0.1030943	0.043
	S_1	0.347172		0.036
	S_3	0.238713		0.025

#### 4.6.4.2 Critical Success Factors Groups

Table 69 below shows the effect of weight and ranking among the groups.

Table 69. Effective weigh and ranking - Critical Success Factors Groups

Observed	SFL (A)	$\sum$ SFL (B)	EWCi	Rank
			C=(A/B)	
Risk related factors	0.798	5.327	0.1498	1
Finance related factors	0.790		0.1483	2
Legal related factors	0.721		0.1353	3
Operation related factors	0.671		0.1260	4
Construction-related factors	0.660		0.1239	5
Stakeholders related factors	0.646		0.1213	6
Design related factors	0.558		0.1047	7
Sports-related factors	0.483		0.0907	8

There would be no overall effective weight as the construct in this model is the same as the observed (latent) variables; hence, this model's analysis is concluded.

#### 4.6.5 Ranking (SEM V.s. RII)

Table 70 below shows the effective weight per construct by determining the average of effective weight per construct using the individual success factors and the effective weight per construct (group) when calculating alone using SEM.

Table 70. Overall group ranking (average) using SEM

<b>Observed</b>	<b>EWCi G</b>	<b>EWCi Ind</b>	<b>Avg.</b>	<b>Rank</b>
Finance related factors	0.148301	0.124505	0.136403	1
Risk related factors	0.149803	0.122892	0.136347	2
Operation related factors	0.125962	0.139463	0.132713	3
Legal related factors	0.135348	0.126851	0.1311	4
Stakeholders related factors	0.121269	0.133304	0.127287	5
Construction related factors	0.123897	0.121865	0.122881	6
Design related factors	0.104749	0.128025	0.116387	7
Sports related factors	0.09067	0.103094	0.096882	8

Table 71 below shows a comparison between ranks following different scenarios, namely the following:

- 1- Group Critical Success Factors using individual survey and SEM.
- 2- Group Critical Success Factors using group data and SEM.
- 3- Average Group Critical Success Factors using SEM.
- 4- Group Critical Success Factors using individual survey and RII.
- 5- Group Critical Success Factors using group data and RII.
- 6- Average Group Critical Success Factors using RII.

Table 71. Group Ranking comparison

<b>Observed</b>	<b>SEM</b>		<b>RII</b>		<b>SEM</b>	<b>RII</b>
	<b>Rank - G</b>	<b>Rank - I</b>	<b>Rank - G</b>	<b>Rank - I</b>	<b>AVG</b>	<b>AVG</b>
Finance related factors	2	5	1	4	1	3
Risk related factors	1	6	7	3	2	4
Operation related factors	4	1	6	5	3	7
Legal related factors	3	4	5	1	4	1
Stakeholders related factors	6	2	3	6	5	6
Construction related factors	5	7	4	2	6	2
Design related factors	7	3	2	7	7	5
Sports related factors	8	8	8	8	8	8

We will follow the SEM average ranking as the study's primary methodology was to utilize the final SEM output for the recommendations and test the hypothesis.

#### 4.7 Individual Critical Success Factors Overall effective weight

The ranking among all individual factors based on the overall effective weight is presented in Table 72 below, where Open and constant communication among stakeholders (ST\_4) has the highest effective weight of 0.05, and Availability of other sports facilities with similar functions (S\_3) has the lowest effective weight of 0.025:

Table 72. Effective weight and Ranking of all Individual Factors

Factor	Observed	OEWi	Rank-G	Rank O
Open and constant communication among stakeholders	ST_4	0.0501	1	1
Effective management of operational problems during operation by the Project Company	O_1	0.0494	1	2
Effective change management system in the operational contract agreements by the stakeholders	O_2	0.0490	2	3
An effective design management plan	D_3	0.0485	1	4
Well defined bidding process for the project	L_3	0.0446	1	5
An effective payment mechanism to the Project Company during the operation stage	F_2	0.0441	1	6
Consistent and effective project performance monitoring	C_3	0.0436	1	7
An effective life cycle cost analysis for the project by the project stakeholders	F_3	0.0431	2	8
Well written contract document protecting all project stakeholders	L_2	0.0430	2	9
Adaptability for the conversion of the sports facility after the event	S_2	0.0427	1	10
Realistic sharing of income by stakeholders	ST_2	0.0422	2	11
Long term demand for the project post-event	O_4	0.0411	3	12
Compatibility skills among stakeholders	ST_5	0.0410	5	13
Proper assessment of the environmental impact of the project	D_1	0.0405	2	14
Effective subcontractor selection procedure by the Project Company	C_1	0.0395	3	15
Availability of Government legislation and policies that support PPP initiatives	L_4	0.0393	3	16
Utilization of innovational design technology (such as BIM- Building Information Modelling)	D_2	0.0390	3	17
Well defined construction period	C_2	0.0389	2	18
Government providing guarantees for the rate of return	F_4	0.0373	3	19
Suitability of the size of the sports facility for usage after the event	S_1	0.0358	2	20
Effective operational risk management during the construction and operation stage	R_4	0.0332	1	21

<b>Factor</b>	<b>Observed</b>	<b>OEWi</b>	<b>Rank-G</b>	<b>Rank O</b>
Timely securing of necessary access permits	R_2	0.0312	2	22
Timely access to the project site by Project Company	R_3	0.0302	3	23
Appropriate risk allocation and sharing among stakeholders	R_1	0.0284	4	24
Availability of other sports facilities with similar functions	S_3	0.0246	3	25



## CHAPTER 5: RESULTS, DISCUSSION AND RECOMMENDATION

### 5.1 Introduction

In this chapter, the study assessed the critical success factors values on the implementation PPP framework for Sports infrastructure utilizing the data from the SEM that defines the relationship between the factors and the groups and subsequently to the implementation PPP framework for Sports infrastructure.

The groups' ranking was determined by the average effective weight of factors and groups to assess the group's hierarchy, while the factors will depend solely on its related data.

### 5.2 Discussion of Results

#### 5.2.1 Testing the Hypothesis

The results indicated that the hypothesis is supported as the SEM has reached the goodness of fit requirements. However, the factors were reduced from 35 critical success factor to 25 critical success factors.

Table 73. the Hypothesis Statement

Code	Hypothesis	Results
<b>ST</b>	Stakeholders have a massive influence on the implementation PPP framework for Sports infrastructure.	Supported
<b>R</b>	Project Risks register has a massive impact on the implementation PPP framework for Sports infrastructure.	Supported
<b>L</b>	Legal structure plays have a leading impact on the implementation PPP framework for Sports infrastructure.	Supported
<b>F</b>	Finance for both private and public plays a significant role in implementing	Supported
<b>D</b>	Design and Innovation plays a major role in the project life cycle.	Supported
<b>C</b>	Construction factors considered a significant and leading factor in the implementation PPP framework for Sports infrastructure.	Supported
<b>O</b>	Operation factors also considered a significant and leading factor in the implementation PPP framework for Sports infrastructure.	Supported
<b>S</b>	Sports-related factors have the least impact on the implementation PPP framework for Sports infrastructure.	Supported

### 5.3 Ranking of Critical Success Factors

The below table shows the groups' ranking using the Average effective weight between the two structural equation models (Group Critical Success Factors and individual Critical Success Factors). The reason behind this is to have a more in-depth understanding of the results.

Finance related factors have the highest average effective weight on the implementation PPP framework for Sports infrastructure, with 0.1364, followed by the Risk related factors with an average effective weight of 0.1363, which is almost identical with the Finance related factors. Operation related factors is ranked third, with an average effective weight of 0.133, and legal-related factors followed in fourth place with an average effective weight of 0.131.

Stakeholders related factors are ranked fifth with an average effective weight of 0.127. In contrast, Construction, Design and Sports related factors ranked in the sixth, seventh and eighth with an average effective weight of 0.123, 0.116 and 0.097.

Table 74. Overall group ranking (average) using SEM

<b>Observed</b>	<b>EWCI G</b>	<b>EWCI Ind</b>	<b>Avg.</b>	<b>Rank</b>
Finance related factors	0.148301	0.124505	0.136403	1
Risk related factors	0.149803	0.122892	0.136347	2
Operation related factors	0.125962	0.139463	0.132713	3
Legal related factors	0.135348	0.126851	0.1311	4
Stakeholders related factors	0.121269	0.133304	0.127287	5
Construction related factors	0.123897	0.121865	0.122881	6
Design related factors	0.104749	0.128025	0.116387	7
Sports related factors	0.09067	0.103094	0.096882	8

The discussion and recommendations of each group results are explained hereinafter.

### 5.3.1. Finance Related Factors

Finance Related Factors was ranked as the first construct affecting the implementation PPP framework for Sports infrastructure with an average effective weight of 0.1364. It had an effective weight of 0.148 in the group critical success factor analysis and 0.125 in the individual critical success factor analysis. Three factors are identified and classified, as shown below.

Table 75. Effective weight and Ranking of Finance Related Factors

Factor	Observed	SFL	$\Sigma$	EWCi	OEWi	Rank
		(A)	SFL (B)	C=(A/B)		
An effective payment mechanism to the Project Company during the operation stage	F_2	0.669		0.354156	0.044	1
An effective life cycle cost analysis for the project by the project stakeholders	F_3	0.654	1.889	0.346215	0.043	2
Government providing guarantees for the rate of return	F_4	0.566		0.299629	0.037	3

An effective payment mechanism to the Project Company during the operation stage (F\_2) has the highest effective weight of 0.044 and ranked first, followed by an effective life cycle cost analysis for the project by the project stakeholders (F\_3) as second with an effective weight of 0.043. The government providing guarantees for the rate of return (F\_4) is the third-ranking factor with an effective weight of 0.037.

### 5.3.2. Risk-Related Factors

Risk Related Factors was ranked as the second construct affecting the implementation PPP framework for Sports infrastructure with an average effective weight of 0.1363. It had an effective weight of 0.150 in the group critical success factor analysis and 0.123 in the individual critical success factor analysis. Four factors are identified and classified, as shown below.

Table 76. Effective weight and Ranking of Risk-Related Factors

Factor	Observed	SFL	$\Sigma$	EWCi	OEWi	Rank
		(A)	SFL (B)	C=(A/B)		
Effective operational risk management during the construction and operation stage	R_4	0.759		0.269915	0.033	1
Timely securing of necessary access permits	R_2	0.713		0.253556	0.031	2
Timely access to the project site by Project Company	R_3	0.69	2.812	0.245377	0.030	3
Appropriate risk allocation and sharing among stakeholders	R_1	0.65		0.231152	0.028	4

During the construction and operation stage (R\_4), effective operational risk management has the highest effective weight of 0.033 and ranked first, followed by Timely securing of necessary access permits (R\_2) as second with an effective weight of 0.031. Timely access to the project site by Project Company (R\_3) is the third-ranking factor with an effective weight of 0.030. At the same time, Appropriate risk allocation and sharing among stakeholders ranked the fourth factor with an effective weight of 0.028.

### 5.3.3. Operation Related Factors

Operation Related Factors was ranked as the third construct affecting the implementation PPP framework for Sports infrastructure with an average effective weight of 0.133. It had an effective weight of 0.126 in the group critical success factor analysis and 0.140 in the individual critical success factor analysis.

Table 77. Effective weight and Ranking of Operations Related Factors

Factor	Observed	SFL	$\Sigma$	EWCi	OEWi	Rank
		(A)	SFL (B)	C=(A/B)		
Effective management of operational problems during operation by the Project Company	O_1	0.683		0.353886	0.049	1
Effective change management system in the operational contract agreements by the stakeholders	O_2	0.678	1.93	0.351295	0.049	2
Long term demand for the project post-event	O_4	0.569		0.294819	0.041	3

Effective management of operational problems during operation by the Project Company (O\_1) has the highest effective weight of 0.049 and ranked first, followed by an effective change management system in the operational contract agreements by the stakeholders (O\_2) an effective weight of 0.049. Long term demand for the project post-event (O\_4) is the third-ranking factor with an effective weight of 0.041.

#### 5.3.4. Legal Related Factors

Legal Related Factors was ranked as the fourth construct affecting the implementation PPP framework for Sports infrastructure with an average effective weight of 0.131. It had an effective weight of 0.135 in the group critical success factor analysis and 0.127 in the individual critical success factor analysis. Three factors are identified and classified, as shown below.

Table 78. Effective weight and Ranking of Legal Related Factors

Factor	Observed	SFL	$\Sigma$	EWCi	OEWi	Rank
		(A)	SFL (B)	C=(A/B)		
Well defined bidding process for the project	L_3	0.781		0.351327	0.045	1
Well written contract document protecting all project stakeholders	L_2	0.754	2.223	0.339181	0.043	2
Availability of Government legislation and policies that support PPP initiatives	L_4	0.688		0.309492	0.039	3

Well defined bidding process for the project (L\_3) has the highest effective weight of 0.045 and ranked first, followed by Well written contract document protecting all project stakeholders (L\_2) as second with an effective weight of 0.043. Availability of Government legislation and policies that support PPP initiatives (L\_4) is the third-ranking factor with an effective weight of 0.039.

### 5.3.5. Stakeholders Related Factors

Stakeholders Related Factors was ranked as the fifth construct affecting the implementation PPP framework for Sports infrastructure with an average effective weight of 0.127. It had an effective weight of 0.121 in the group critical success factor analysis and 0.133 in the individual critical success factor analysis. Three factors are identified and classified, as shown below.

Table 79. Effective weight and Ranking of Stakeholders Related Factors

Factor	Observed	SFL	$\Sigma$	EWCi	OEWi	Rank
		(A)	SFL (B)	C=(A/B)		
Open and constant communication among stakeholders	ST_4	0.736		0.37551	0.050	1
Realistic sharing of income by stakeholders	ST_2	0.621	1.96	0.316837	0.042	2
Compatibility skills among stakeholders	ST_5	0.603		0.307653	0.041	3

Open and constant communication among stakeholders (ST\_4) has the highest effective weight of 0.050 and ranked first, followed by Realistic sharing of income by stakeholders (ST\_2) as second with an effective weight of 0.042. Compatibility skills among stakeholders (ST\_5) are the third-ranking factor with an effective weight of 0.041.

### 5.3.6. Construction-related Factors

Construction Related Factors was ranked as the sixth construct affecting the implementation PPP framework for Sports infrastructure with an average effective weight of 0.123. It had an effective weight of 0.124 in the group critical success factor analysis and 0.122 in the individual critical success factor analysis. Three factors are identified and classified, as shown below.

Table 80. Effective weight and Ranking of Construction Related Factors

Factor	Observed	SFL	$\Sigma$	EWCi	OEWi	Rank
		(A)	SFL (B)	C=(A/B)		
Consistent and effective project performance monitoring	C_3	0.807		0.357396	0.044	1
Effective subcontractor selection procedure by the Project Company	C_1	0.731	2.258	0.323738	0.039	2
Well defined construction period	C_2	0.72		0.318866	0.039	3

Consistent and effective project performance monitoring (C\_3) has the highest effective weight of 0.044 and ranked first, followed by the effective subcontractor selection procedure by the Project Company (C\_1) as second with an effective weight of 0.039. Well defined construction period (C\_2) is the third-ranking factor with an effective weight of 0.039.

### 5.3.7. Design Related Factors

Design Related Factors was ranked as the seventh construct affecting the implementation PPP framework for Sports infrastructure with an average effective weight of 0.116. It had an effective weight of 0.105 in the group critical success factor analysis and 0.128 in the individual critical success factor analysis. Three factors are identified and classified, as shown below.

Table 81. Effective weight and Ranking of Design Related Factors

Factor	Observed	SFL	$\Sigma$	EWCi	OEWi	Rank
		(A)	SFL (B)	C=(A/B)		
An effective design management plan	D_3	0.744		0.378626	0.048	1
Proper assessment of the environmental impact of the project	D_1	0.622	1.965	0.316539	0.041	2
Utilization of innovational design technology (such as BIM- Building Information Modelling)	D_2	0.599		0.304835	0.039	3

An effective design management plan (D\_3) has the highest effective weight of 0.048 and ranked first, followed by a proper assessment of the environmental impact of the

project (D\_1) as second with an effective weight of 0.041. Utilization of innovational design technology (such as BIM- Building Information Modelling) (D\_2) is the third-ranking factor with an effective weight of 0.039.

### 5.3.8. Sports-Related Factors

Sports-Related Factors was ranked as the eighth and the last construct affecting the implementation PPP framework for Sports infrastructure with an average effective weight of 0.097. It had an effective weight of 0.09 in the group critical success factor analysis and 0.103 in the individual critical success factor analysis. Three factors are identified and classified, as shown below.

Table 82. Effective weight and Ranking of Sports-Related Factors

Factor	Observed	SFL (A)	$\Sigma$ SFL (B)	EWCi C=(A/B)	OEWi	Rank
Adaptability for the conversion of the sports facility after the event	S_2	0.798		0.414115	0.043	1
Suitability of the size of the sports facility for usage after the event	S_1	0.669	1.927	0.347172	0.036	2
Availability of other sports facilities with similar functions	S_3	0.46		0.238713	0.025	3

Adaptability for the conversion of the sports facility after the event (S\_2) has the highest effective weight of 0.043 and ranked first, followed by the Suitability of the size of the sports facility for usage after the event (S\_1) as second with an effective weight of 0.036. The Availability of other sports facilities with similar functions (S\_3) is the third-ranking factor with an effective weight of 0.025.



## 5.4 Conclusion

This research primarily focused on challenges that arise when hosting major sports events and the organizing committee's infrastructure to allow for the event to happen alongside the long-term impact for these infrastructure post events and how they intend to be used by analyzing the critical success factors.

The proposed solution is to engage the private sector in constructing these sports infrastructure under the PPP module so that the financial burden is shared among parties (Private and Public). Subsequently, innovative ideas can be extracted from the private sector to ensure proper usage of the facility post-event rather than becoming a white elephant draining the public sector financial resources.

This was proven successful in some countries like Brazil 2014 world cup preparation, where all the stadiums except one were completed ahead of schedule under the PPP module. It was also proven that the stadiums constructed under traditional procurement method funded by the public fund, in some cases, end up becoming white elephants.

The 35 factors identified as success factors grouped into the eight categories were tested against their impact on the implementation PPP framework for Sports infrastructure based on the survey data obtained from professionals all over the world, where each factor and group has a significant effect on the overall Framework starting with Stakeholders, Risks allocation, Legal structure, finance for both private and public plays, design and innovation, Construction factors, Operation factors and finally, Sports-related factors. The hypothesis is supported by the result obtained with different effective weight resulting from the SEM, as explained earlier. Accordingly, the paper objectives had been met, and the factors, groups had been ranked and classified based on their overall effective weight on the subject study.

## 5.5 Recommendations

A PPP framework should include five essential elements explained in the literature review chapter as follows.

1. Implementing Principles

A set of strategic and foundational outlines sets the boundaries for using the PPP as a procurement option, including the overall objectives for the scope and the procurement and tender processes and associated regulations.

2. Operational Framework or Process Management Framework

This consists of a set of rules and procedures to identify, prepare and assess or appraise the projects, along with information about preparing the PPP contract, the RFP structure and the management of the tender and subsequent contract.

3. Fiscal Management Framework

Describes the rules and procedures that control the PPPs' aggregated exposure.

4. Institutional Framework

Describes any government-specific rules relating to the management and governance of the PPP; and

5. Other Governance Related Matters

Other rules, processes, procedures, and responsibilities.

Although the study analysed the critical success factors that fall under specific groups (finance, risk, operation, legal, stakeholders, construction, design and sports) related, they are interconnected under the five items that define the overall framework arrangement.

The SEM's advantage is its ability to consider the interconnections between the factors and the groups.

To enable the project success delivery under the PPP module, six steps need to be completed as follows:

PHASE 1: Identification phase

PHASE 2: Project Appraisal

PHASE 3: Tender Draft

PHASE 4: Awarding Phase

PHASE 5: Construction Stage

PHASE 6: Operation and Handing over Stage

As explained above, the PPP process is lengthy. It focuses on the overall project life cycle and not only a part such as construction; hence, extreme care and attention must be well considered by all stakeholders such as requirements, procedures, protocols, communications and alike.

To summarise, the study recommended the following parameters to be taken into consideration while preparing a PPP plan for sports infrastructure in following the same order based on the effective weight resulted from the SEM study:

- Define a plan that is related to the overall life cycle of the project. Sub-plans must be extracted from the primary plan since PPP is a long-term commitment by many stakeholders.
- Clear and very well-defined objectives drive the plan must be in place.

The word 'Framework' is basically a policy statement, where all the factors are

interconnected together and have to read in connection with each other. Detail recommendations based on each group are listed below:

#### *5.5.1 Finance Related Factors recommendations*

- Life cycle cost analysis is a critical part of the project documents. It foresees the future commitments by the public party and the private party's expectation; Hence, it must be thoroughly studied and evaluated.
- Payment mechanism, payment deduction, and guarantees are vital for the private parties, and these elements guarantee the lenders as their works' performance.

#### *5.5.2. Risk-Related Factors recommendations*

- One of the primary objectives for using PPP is to allocate the risk to the party that can manage it efficiently and adequately. All project stakeholders have to be on board with this concept rather than offsetting the responsibility to another party. The risk must be very well-identified, and duties are assigned to each stakeholder for his part in a clear transparent manner, including the risk premium.
- The primary method to tackle risks is money. Allocating the risk properly to the party who can manage it will reduce the project cost and improve the project efficiency. Still, the challenge remains in identifying the expected risks of each group factor and at each stage.

#### *5.5.3. Operation Related Factors recommendations*

- Operation is a challenging part for both public and private party. Involving the correct stakeholder to undertake this scope at an earlier stage would have numerous advantages. For example, innovation in design suits operation requirements, familiarity, shared environment database protecting all recorded

information from losses.

- PPPs are much more complicated than a traditional procurement method. Therefore, there is a risk that resources may be invested in projects that are unsuitable and therefore wasted. More often, specialized skills resources are required and a lengthy timeline for project preparation, which might discourage the public sector from proceeding further with PPP.
- The legal principle is a mandatory aspect that needs to be completed by both the public and the private parties in due diligence. The process streamlines, the changes modules, the step-in rights are specific legal aspects that need to be determined and established jointly.

#### *5.5.4. Legal Related Factors recommendations*

- The country's legal scheme and application of the law are also challenging, as PPP again is not a traditional procurement method, and uniquely tailor-made laws need to be in place. Countries can establish these laws based on previous experiences and successful application in the same field.
- For the countries to understand the application of the PPP procurement module, the recommendations suggest undergoing one or two PPP projects but under a state-owned company's partnership in place of the private partner and test the capability of the current legalization, process and staff to understand its SWOT (Strength, Weakness, Opportunity, and Threat) before taking the risk of promoting PPP worldwide. This might be a lengthy process, but it will give the investors an extended vision of comfortability regarding their investment.
- The bedding process needs to be controlled in terms of changes, as the PPP preparation and managing process is more complicated than the traditional procurement method. Any changes to the requirements during the tender stage

will affect the project process and add additional costs to the private party, which will lead to the market's frustration in general. Precise requirements have to be defined at the early stages, with options in case of uncertainty. The private party is aware of the possible outcome of his investment, including sensitivity analysis and alike.

#### *5.5.5. Stakeholders Related Factors recommendations*

- Stakeholders play a significant factor in the project, from externality and internality perspectives. The risk of poor identification, lack of communication, transparency can put the overall project life cycle at risk.
- Moreover, non-realistic sharing among parties might be developing non-balanced risk allocation, which is the main objective of the PPP module. To recap, the risk is transferred to the party who can manage it better. This is linked to the amount of investments and shares between parties, despite debt, equity or any other participation form.

#### *5.5.6. Construction Related Factors recommendations*

- Several aspects govern the project life cycle, and the construction period is one of the essential items. The realistic construction period is part of the technical feasibility that will feed the project's commercial feasibility. Undermining the construction period's importance, including failure to track performance, will lead to project losses and might reach disputes and legal actions. The one who will suffer the most is the public party, as the objectives are not met due to miss evaluating the project's technical feasibility.
- Moreover, the subcontractor's selection (for individual tasks) can differentiate between project success and failure. These subcontractors are defined as high-impact stakeholders who need to be appropriately managed by analyzing their

SWOT (Strength, Weakness, Opportunity and Threat) and determining the best scope combination that can be delivered between them and the main contractor. Again, open and transparent communication is the key to success or failure.

- Part of the technical feasibility is the design aspects of the works, given that one of the PPP strengths is utilizing the private party experience for more innovative ideas.

#### *5.5.7. Design Related Factors recommendations*

- Design can't be less crucial than any other aspects in the project life cycle. It will feed the construction, validate the cost by applying value engineering as an example, enhance the service delivery by considering the operational requirements thoroughly in the design. A proper design and engineering management plan must be well defined and in place to achieve the PPP module's maximum outcome.
- Another benefit of the PPP is the data transfer among phases (from tender to construction, to operate up to the hand backstage). Typically, around 10% to 15% are getting lost between stages when new stakeholders are engaged at different stages. However, as the stakeholders are in place for the project's whole life cycle, this is more controllable in the PPP module. In addition to that, BIM is suggested to work as CDM (Common Data Environment). All the information would be stored at one location accessible to all relevant stakeholders at any stage with proper access control.

#### *5.5.8. Sports-related Factors recommendations*

- Finally, since the paper focuses primarily on social infrastructure, namely the sports assets, these assets are usually not commercially viable unless specific criteria are met, such as uniqueness, modularity for repurposing, the availability

of the other 'similar functions assets'...etc. This will add some additional risks to the public party to provide the required fund, although not upfront, still needed to deliver the service. It is essential to pre-define the asset's real need before taking the green light decision to undergo such infrastructure investment and procurement decision.

- Moreover, and in case of commercial feasibility can be achieved for the asset even through repurposing or any other measure (user pay PPP), the size of the facility is considered a critical item as the commercial viability can be calculated based on the income per square meter at the appraisal stage. This factor might hinder this.

From the private sector's view, four points are essential in the framework; the first three are related to a PPP programme concept. Private sector PPP framework considerations:

- 1- Private developers are interested in markets that provide a pipeline of PPP projects. This offers the opportunity to generate economies of scale in bid preparation and management of tenders and projects.
- 2- Secondly, the framework will provide consistency. It ensures that different projects are structured and managed consistently, which lowers the private sector's costs and builds confidence in the market.
- 3- The third point relates to the private sector's need to be confident that the government can manage a pipeline and demonstrate a commitment to the PPP approach over the longer term.
- 4- Finally, concerns such as long-term fiscal sustainability, political commitment to PPPs, societal acceptance of the tool, talent/experience retention, and a



minimum legislative structure offering the opportunity to procure PPPs would affect the private sector. Many of these considerations affect the viability and preparation of each project. However, they do affect the PPP tool's long-term viability and reliability, as well as the nature of a proper pipeline.

## REFERENCES

- Allmers, S., & Maennig, W. (2009). Economic impacts of the FIFA soccer world cups in France 1998, Germany 2006, and outlook for South Africa 2010. *Eastern economic journal*, 35(4), 500-519.
- Alm, J., Solberg, H. A., Storm, R. K., & Jakobsen, T. G. (2016). Hosting major sports events: The challenge of taming white elephants. *Leisure Studies*, 35(5), 564-582.
- Azzali, S. (2019). Mega sporting events and their impact on the built environment: Lessons learned from the past. *A/ Z ITU Journal of the Faculty of Architecture*, 16(2), 25-37.
- Bagozzi, R. P., & Yi, Y. (1988). On the evaluation of structural equation models. *Journal of the academy of marketing science*, 16(1), 74-94.
- Baumann, R., & Matheson, V. (2013). Infrastructure investments and mega-sports events: comparing the experience of developing and industrialized countries.
- Chen, Z., Zhao, Y., Zhou, X., & Zhang, L. (2020). Investigating Critical Factors That Encourage Private Partners to Participate in Sports and Leisure Characteristic Town Public-Private Partnerships: Evidence from China. *Sustainability*, 12(8), 3212.
- dos Reis, C. J. O., & Cabral, S. (2017). Public-private partnerships (PPP) in mega-sport events: a comparative study of the provision of sports arenas for the 2014 Fifa World Cup in Brazil. *RAP: Revista Brasileira de Administração Pública*, 51(4).
- Hair, J. F., Black, W. C., Babin, B. J., & Anderson, R. E. (2014). *Multivariate data analysis* (7th ed.). New Jersey, USA: Pearson.
- Osei-Kyei, R., & Chan, A. P. (2015). Review of studies on the Critical Success Factors for Public-Private Partnership (PPP) projects from 1990 to 2013. *International*

- journal of project management*, 33(6), 1335-1346.
- Osei-Kyei, R., Chan, A. P., Javed, A. A., & Ameyaw, E. E. (2017). Critical success criteria for public-private partnership projects: international experts' opinion. *International Journal of Strategic Property Management*, 21(1), 87-100.
- Robinson, J. A., & Torvik, R. (2005). White elephants. *Journal of public economics*, 89(2-3), 197-210.
- Rockart, J. F. (1980). The changing role of the information systems executive: a critical success factors perspective.
- Seymen, O. (2019). *Recommendations for the enhancement of economic impact of hosting mega sport events*.
- Yuen, B. (2012). Public-private partnership in Singapore sports hub. In *Zur Ökonomik von Spitzenleistungen im internationalen Sport* (pp. 207-229): Hamburg: Hamburg University Press.
- Zwikael, O., & Globerson, S. (2006). From critical success factors to critical success processes. *International journal of production research*, 44(17), 3433-3449.
- Allmers, S., & Maennig, W. (2009). Economic impacts of the FIFA soccer world cups in France 1998, Germany 2006, and outlook for South Africa 2010. *Eastern economic journal*, 35(4), 500-519.
- Alm, J., Solberg, H. A., Storm, R. K., & Jakobsen, T. G. (2016). Hosting major sports events: The challenge of taming white elephants. *Leisure Studies*, 35(5), 564-582.
- Azzali, S. (2019). Mega sporting events and their impact on the built environment: Lessons learned from the past. *A/ Z ITU Journal of the Faculty of Architecture*, 16(2), 25-37.
- Bagozzi, R. P., & Yi, Y. (1988). On the evaluation of structural equation models.

*Journal of the academy of marketing science*, 16(1), 74-94.

- Baumann, R., & Matheson, V. (2013). Infrastructure investments and mega-sports events: comparing the experience of developing and industrialized countries.
- Chen, Z., Zhao, Y., Zhou, X., & Zhang, L. (2020). Investigating Critical Factors That Encourage Private Partners to Participate in Sports and Leisure Characteristic Town Public-Private Partnerships: Evidence from China. *Sustainability*, 12(8), 3212.
- dos Reis, C. J. O., & Cabral, S. (2017). Public-private partnerships (PPP) in mega-sport events: a comparative study of the provision of sports arenas for the 2014 Fifa World Cup in Brazil. *RAP: Revista Brasileira de Administração Pública*, 51(4).
- Osei-Kyei, R., & Chan, A. P. (2015). Review of studies on the Critical Success Factors for Public-Private Partnership (PPP) projects from 1990 to 2013. *International journal of project management*, 33(6), 1335-1346.
- Osei-Kyei, R., Chan, A. P., Javed, A. A., & Ameyaw, E. E. (2017). Critical success criteria for public-private partnership projects: international experts' opinion. *International Journal of Strategic Property Management*, 21(1), 87-100.
- Robinson, J. A., & Torvik, R. (2005). White elephants. *Journal of public economics*, 89(2-3), 197-210.
- Rockart, J. F. (1980). The changing role of the information systems executive: a critical success factors perspective.
- Seymen, O. (2019). *Recommendations for the enhancement of economic impact of hosting mega sport events*.
- Yuen, B. (2012). Public-private partnership in Singapore sports hub. In *Zur Ökonomik von Spitzenleistungen im internationalen Sport* (pp. 207-229): Hamburg: Hamburg University Press.

- Zwikael, O., & Globerson, S. (2006). From critical success factors to critical success processes. *International journal of production research*, 44(17), 3433-3449.
- Gaffney, C. (2013). Between discourse and reality: The un-sustainability of mega-event planning. *Sustainability*, 5(9), 3926-3940.
- Jefferies, M. (2006). Critical success factors of public, private sector partnerships: A case study of the Sydney SuperDome. *Engineering, Construction and Architectural Management*.
- Jefferies, M., Gameson, R. O. D., & Rowlinson, S. (2002). Critical success factors of the BOOT procurement system: reflections from the Stadium Australia case study. *Engineering, Construction and Architectural Management*.
- Tiong, R. L. (1996). CSFs in competitive tendering and negotiation model for BOT projects. *Journal of construction engineering and management*, 122(3), 205-211.
- Mladenovic, G., Vajdic, N., Wüdsch, B., & Temeljotov-Salaj, A. (2013). Use of key performance indicators for PPP transport projects to meet stakeholders' performance objectives. *Built Environment Project and Asset Management*.
- Ozdoganm, I. D., & Talat Birgonul, M. (2000). A decision support framework for project sponsors in the planning stage of build-operate-transfer (BOT) projects. *Construction Management & Economics*, 18(3), 343-353.
- Xu, Y., Yeung, J. F., Chan, A. P., Chan, D. W., Wang, S. Q., & Ke, Y. (2010). Developing a risk assessment model for PPP projects in China—A fuzzy synthetic evaluation approach. *Automation in Construction*, 19(7), 929-943.
- Jacobson, C., & Choi, S. O. (2008). Success factors: public works and public-private partnerships. *International journal of public sector management*.
- Li, B., Akintoye, A., Edwards, P. J., & Hardcastle, C. (2004, September). Risk

- treatment preferences for PPP/PFI construction projects in the UK. In *Proceedings: ARCOM Conference, Heriot-Watt University* (Vol. 2, pp. 1259-1268).
- Cartlidge, D. (2006). *Public-private partnerships in construction*. Routledge.
- Hwang, B. G., Zhao, X., & Gay, M. J. S. (2013). Public-private partnership projects in Singapore: Factors, critical risks and preferred risk allocation from the perspective of contractors. *International journal of project management*, 31(3), 424-433.
- Robinson, H. S., & Scott, J. (2009). Service delivery and performance monitoring in PFI/PPP projects. *Construction management and economics*, 27(2), 181-197.
- Ng, S. T., Wong, Y. M., & Wong, J. M. (2012). Factors influencing the success of PPP at feasibility stage—A tripartite comparison study in Hong Kong. *Habitat International*, 36(4), 423-432.
- Liu, J., Love, P. E., Smith, J., Regan, M., & Davis, P. R. (2015). Life cycle critical success factors for public-private partnership infrastructure projects. *Journal of Management in Engineering*, 31(5), 04014073.
- Geng, J., Teferle, F. N., Meng, X., & Dodson, A. H. (2011). Towards PPP-RTK: Ambiguity resolution in real-time precise point positioning. *Advances in space research*, 47(10), 1664-1673.

## APPENDIX 1: SURVEY QUESTIONNAIRE

Title of the research: Critical Success Factors (CSF) for implementation of Public-Private Partnership (PPP) in Sports Infrastructure Post-event

The questionnaire has been prepared in the scope of an ongoing research study as titled above in the department of Engineering Management at Qatar University. All collected information will be kept **absolutely confidential**.

Best Regards,

Researcher: Albara Abukeshek

Advisor: Prof Murat Gunduz

[As1805266@qu.edu.qa](mailto:As1805266@qu.edu.qa)

[a.abukeshek@outlook.com](mailto:a.abukeshek@outlook.com)

0097455776169

This research will work out a conceptual framework for the Sports Infrastructure Assets (stadium) transformation after a major event involving the private sector in this transformation, adapting the Public-Private Partnership module (PPP). We will focus on the critical success factors to ensure the success of this transformation.

This will result in utilizing these existing assets in a partnership module through rehabilitation/repurposing, which can benefit both private and public sectors in many ways and establish a long term relationship to achieve more sustainable growth for both sectors without adding any financial burden to the public sector.

### **Part One: General Information**

Dear Participant:

This part consists of questions related to your organization. Please select the suitable choice that represents your profession from the choices below:

Which Organization can represent your major experience?

*Mark only one choice*

- Public Sector
- Private Sector
- Semi-Government
- Others: \_\_\_\_\_

What sector/organization can represent your major experience?

*Mark only one choice*

- Employer/Client
- Contractor
- Consultant
- Designer
- Project Manager/Construction Manager
- Facility Management/Operation
- Finance/Banking
- Developer
- Legal Affairs
- Universities (Research and development)
- Others: \_\_\_\_\_

What is your position in your current role?

*Mark only one choice*

- Executive Manager (CEO, CFO, COO, CO)
- Department Manager/Head
- Senior Manager
- Mid Senior Manager
- Standard Level
- Others: \_\_\_\_\_

What is your area(s) of expertise?

*Choose all that applicable*

- Construction Management
- Design and Engineering
- Innovation (Research and development)
- Facility/Operation management
- Legal Management
- Commercial and Contracts
- Controlling and Risk Management
- Project/Construction Management
- Tendering and estimation
- Real-estate and development
- Assets Management
- Finance/account management
- Others: \_\_\_\_\_



Which type of projects you are familiar with and reflect your experience?

*Choose all that applicable*

- Building Constructions
- Infrastructure (Road, Bridges, Railway...etc.)
- Utilities (Water, Electricity, Drainage, Telecom)
- Oil and Gas
- Sports Facilities
- Urban Planning and Transportation
- Theme Parks and museums
- Information technology (IT)
- Others: \_\_\_\_\_

What is your total number of years of working experience?

*Mark only one choice*

- Less than or equal to 5 years
- (6-10) years
- (11-15) years
- (16-20) years
- (21-25) years
- More than 25 years

## **Part Two: Critical Success Factors Model**

### **Introduction:**

(35) factors falling under (8) categories are chosen for the study, which aims to focus on classifying the importance and the impact of these factors on the transformation of Sports Infrastructure asset post-event using the Public-Private Partnership module.

Please select the *most suitable expression next to each factor (one only)*, considering its **Importance level** on Sports Infrastructure asset transformation after the event is completed using the PPP module.

As an example, Clarity of roles and responsibilities among stakeholders has a **very high impact**; hence, it is an '**extremely important**' Critical Success Factor.

### **The question we need to answer is:**

*What is the importance of the following factors on "Implementation of Public-Private Partnership (PPP) in Sports Infrastructure transformation Post-event (Legacy)"?*

**Important definitions:**

**‘Post-event’** means after the full completion of the event.

**‘Public-Private Partnership’** is a corporative arrangement between public and private sectors in a long term that involves the private sector in the financing, construction, operation and handing over a certain project.

**‘Project Company’** stands for the Project Company that will do the construction, operating the facility and returning the facility after the concession period is completed.

**‘Concession period’** is the period that starts after the construction (transformation) is completed until the project's return.

**‘Project’** stands for the sports infrastructure, which is a Stadium in our study.

**Group 1: Stakeholders related factors (5 factors)**

1.1 Clarity of roles and responsibilities among stakeholders

*Mark only one choice per row*

Not Important	Low important	Moderate Important	High Important	Extremely Important
<input type="checkbox"/>	<input type="checkbox"/>	<input type="checkbox"/>	<input type="checkbox"/>	<input type="checkbox"/>

1.2 Realistic sharing of income by stakeholders

*Mark only one choice per row*

Not Important	Low important	Moderate Important	High Important	Extremely Important
<input type="checkbox"/>	<input type="checkbox"/>	<input type="checkbox"/>	<input type="checkbox"/>	<input type="checkbox"/>

1.3 Public/community support to the project

*Mark only one choice per row*

Not Important	Low important	Moderate Important	High Important	Extremely Important
<input type="checkbox"/>	<input type="checkbox"/>	<input type="checkbox"/>	<input type="checkbox"/>	<input type="checkbox"/>

1.4 Open and constant communication among stakeholders

*Mark only one choice per row*

Not Important	Low important	Moderate Important	High Important	Extremely Important
<input type="checkbox"/>	<input type="checkbox"/>	<input type="checkbox"/>	<input type="checkbox"/>	<input type="checkbox"/>

1.5 Compatibility skills among stakeholders

*Mark only one choice per row*

Not Important	Low important	Moderate Important	High Important	Extremely Important
<input type="checkbox"/>	<input type="checkbox"/>	<input type="checkbox"/>	<input type="checkbox"/>	<input type="checkbox"/>

**Group 2: Risk related factors (4 factors)**

2.1 Appropriate risk allocation and sharing among stakeholders

*Mark only one choice per row*

Not Important	Low important	Moderate Important	High Important	Extremely Important
<input type="checkbox"/>	<input type="checkbox"/>	<input type="checkbox"/>	<input type="checkbox"/>	<input type="checkbox"/>

2.2 Timely securing of necessary access permits

*Mark only one choice per row*

Not Important	Low important	Moderate Important	High Important	Extremely Important
<input type="checkbox"/>	<input type="checkbox"/>	<input type="checkbox"/>	<input type="checkbox"/>	<input type="checkbox"/>

2.3 Timely access to the project site by Project Company

*Mark only one choice per row*

Not Important	Low important	Moderate Important	High Important	Extremely Important
<input type="checkbox"/>	<input type="checkbox"/>	<input type="checkbox"/>	<input type="checkbox"/>	<input type="checkbox"/>

2.4 Effective operational risk management during the construction and operation stage

*Mark only one choice per row*

Not Important	Low important	Moderate Important	High Important	Extremely Important
<input type="checkbox"/>	<input type="checkbox"/>	<input type="checkbox"/>	<input type="checkbox"/>	<input type="checkbox"/>

**Group 3: Finance related factors (5 factors)**

3.1 A competitive financial proposal by the Project Company

*Mark only one choice per row*

Not Important	Low important	Moderate Important	High Important	Extremely Important
<input type="checkbox"/>	<input type="checkbox"/>	<input type="checkbox"/>	<input type="checkbox"/>	<input type="checkbox"/>

3.2 An effective payment mechanism to the Project Company during the operation stage

*Mark only one choice per row*

Not Important	Low important	Moderate Important	High Important	Extremely Important
<input type="checkbox"/>	<input type="checkbox"/>	<input type="checkbox"/>	<input type="checkbox"/>	<input type="checkbox"/>

3.3 An effective life cycle cost analysis for the project by the project stakeholders

*Mark only one choice per row*

Not Important	Low important	Moderate Important	High Important	Extremely Important
<input type="checkbox"/>	<input type="checkbox"/>	<input type="checkbox"/>	<input type="checkbox"/>	<input type="checkbox"/>

3.4 Government providing guarantees for the rate of return

*Mark only one choice per row*

Not Important	Low important	Moderate Important	High Important	Extremely Important
<input type="checkbox"/>	<input type="checkbox"/>	<input type="checkbox"/>	<input type="checkbox"/>	<input type="checkbox"/>

3.5 Stable macroeconomic condition

*Mark only one choice per row*

Not Important	Low important	Moderate Important	High Important	Extremely Important
<input type="checkbox"/>	<input type="checkbox"/>	<input type="checkbox"/>	<input type="checkbox"/>	<input type="checkbox"/>

**Group 4: Legal related factors (4 factors)**

4.1 Well-structured legal framework during construction and operation stages

*Mark only one choice per row*

Not Important	Low important	Moderate Important	High Important	Extremely Important
<input type="checkbox"/>	<input type="checkbox"/>	<input type="checkbox"/>	<input type="checkbox"/>	<input type="checkbox"/>

4.2 Well written contract document protecting all project stakeholders.

*Mark only one choice per row*

Not Important	Low important	Moderate Important	High Important	Extremely Important
<input type="checkbox"/>	<input type="checkbox"/>	<input type="checkbox"/>	<input type="checkbox"/>	<input type="checkbox"/>

4.3 Well defined bidding process for the project

*Mark only one choice per row*

Not Important	Low important	Moderate Important	High Important	Extremely Important
<input type="checkbox"/>	<input type="checkbox"/>	<input type="checkbox"/>	<input type="checkbox"/>	<input type="checkbox"/>

4.4 Availability of Government legislation and policies that support PPP initiatives

*Mark only one choice per row*

Not Important	Low important	Moderate Important	High Important	Extremely Important
<input type="checkbox"/>	<input type="checkbox"/>	<input type="checkbox"/>	<input type="checkbox"/>	<input type="checkbox"/>

**Group 5: Design related factors (4 factors)**

5.1 Proper assessment of the environmental impact of the project

*Mark only one choice per row*

Not Important	Low important	Moderate Important	High Important	Extremely Important
<input type="checkbox"/>	<input type="checkbox"/>	<input type="checkbox"/>	<input type="checkbox"/>	<input type="checkbox"/>

5.2 Utilization of innovational design technology (such as BIM- Building Information Modelling)

*Mark only one choice per row*

Not Important	Low important	Moderate Important	High Important	Extremely Important
<input type="checkbox"/>	<input type="checkbox"/>	<input type="checkbox"/>	<input type="checkbox"/>	<input type="checkbox"/>

5.3 An effective design management plan

*Mark only one choice per row*

Not Important	Low important	Moderate Important	High Important	Extremely Important
<input type="checkbox"/>	<input type="checkbox"/>	<input type="checkbox"/>	<input type="checkbox"/>	<input type="checkbox"/>

5.4 Consideration of sustainability in design, including modularity, post-event usage

*Mark only one choice per row*

Not Important	Low important	Moderate Important	High Important	Extremely Important
<input type="checkbox"/>	<input type="checkbox"/>	<input type="checkbox"/>	<input type="checkbox"/>	<input type="checkbox"/>

**Group 6: Construction-related factors (5 factors)**

6.1 Effective subcontractor selection procedure by the Project Company

*Mark only one choice per row*

Not Important	Low important	Moderate Important	High Important	Extremely Important
<input type="checkbox"/>	<input type="checkbox"/>	<input type="checkbox"/>	<input type="checkbox"/>	<input type="checkbox"/>

6.2 Well defined construction period

*Mark only one choice per row*

Not Important	Low important	Moderate Important	High Important	Extremely Important
<input type="checkbox"/>	<input type="checkbox"/>	<input type="checkbox"/>	<input type="checkbox"/>	<input type="checkbox"/>

6.3 Consistent and effective project performance monitoring

*Mark only one choice per row*

Not Important	Low important	Moderate Important	High Important	Extremely Important
<input type="checkbox"/>	<input type="checkbox"/>	<input type="checkbox"/>	<input type="checkbox"/>	<input type="checkbox"/>

6.4 Effective safety management plan during construction and operation phase

*Mark only one choice per row*

Not Important	Low important	Moderate Important	High Important	Extremely Important
<input type="checkbox"/>	<input type="checkbox"/>	<input type="checkbox"/>	<input type="checkbox"/>	<input type="checkbox"/>

6.5 Effective quality management plan during construction and operation phase

*Mark only one choice per row*

Not Important	Low important	Moderate Important	High Important	Extremely Important
<input type="checkbox"/>	<input type="checkbox"/>	<input type="checkbox"/>	<input type="checkbox"/>	<input type="checkbox"/>

**Group 7: Operation related factors (5 factors)**

7.1 Effective management of operational problems during operation by the Project Company

*Mark only one choice per row*

Not Important	Low important	Moderate Important	High Important	Extremely Important
<input type="checkbox"/>	<input type="checkbox"/>	<input type="checkbox"/>	<input type="checkbox"/>	<input type="checkbox"/>

7.2 Effective change management system in the operational contract agreements by the stakeholders

*Mark only one choice per row*

Not Important	Low important	Moderate Important	High Important	Extremely Important
<input type="checkbox"/>	<input type="checkbox"/>	<input type="checkbox"/>	<input type="checkbox"/>	<input type="checkbox"/>

7.3 Well defined operation (concession) period

*Mark only one choice per row*

Not Important	Low important	Moderate Important	High Important	Extremely Important
<input type="checkbox"/>	<input type="checkbox"/>	<input type="checkbox"/>	<input type="checkbox"/>	<input type="checkbox"/>

7.4 Long term demand for the project post-event

*Mark only one choice per row*

Not Important	Low important	Moderate Important	High Important	Extremely Important
<input type="checkbox"/>	<input type="checkbox"/>	<input type="checkbox"/>	<input type="checkbox"/>	<input type="checkbox"/>

7.5 Consideration of sustainability in operation while maintaining service levels

*Mark only one choice per row*

Not Important	Low important	Moderate Important	High Important	Extremely Important
<input type="checkbox"/>	<input type="checkbox"/>	<input type="checkbox"/>	<input type="checkbox"/>	<input type="checkbox"/>

**Group 8: Sports Related Factors (3 factors)**

8.1 Suitability of the size of the sports facility for usage after the event

*Mark only one choice per row*

Not Important	Low important	Moderate Important	High Important	Extremely Important
<input type="checkbox"/>	<input type="checkbox"/>	<input type="checkbox"/>	<input type="checkbox"/>	<input type="checkbox"/>

8.2 Adaptability for the conversion of the sports facility after the event

*Mark only one choice per row*

Not Important	Low important	Moderate Important	High Important	Extremely Important
<input type="checkbox"/>	<input type="checkbox"/>	<input type="checkbox"/>	<input type="checkbox"/>	<input type="checkbox"/>

8.3 Availability of other sports facilities with similar functions

*Mark only one choice per row*

Not Important	Low important	Moderate Important	High Important	Extremely Important
<input type="checkbox"/>	<input type="checkbox"/>	<input type="checkbox"/>	<input type="checkbox"/>	<input type="checkbox"/>

**Critical Success Factor Groups**

What is the importance of the following groups on Public-Private Partnership?

*Mark only one choice per row*

Group	Not Important	Low important	Moderate Important	High Important	Extremely Important
G01: Stakeholders related factors	<input type="checkbox"/>	<input type="checkbox"/>	<input type="checkbox"/>	<input type="checkbox"/>	<input type="checkbox"/>
G02: Risk related factors	<input type="checkbox"/>	<input type="checkbox"/>	<input type="checkbox"/>	<input type="checkbox"/>	<input type="checkbox"/>
G03: Finance related factors	<input type="checkbox"/>	<input type="checkbox"/>	<input type="checkbox"/>	<input type="checkbox"/>	<input type="checkbox"/>
G04: Legal related factors	<input type="checkbox"/>	<input type="checkbox"/>	<input type="checkbox"/>	<input type="checkbox"/>	<input type="checkbox"/>
G05: Design related factors	<input type="checkbox"/>	<input type="checkbox"/>	<input type="checkbox"/>	<input type="checkbox"/>	<input type="checkbox"/>
G06: Construction-related factors	<input type="checkbox"/>	<input type="checkbox"/>	<input type="checkbox"/>	<input type="checkbox"/>	<input type="checkbox"/>
G07: Operation related factors	<input type="checkbox"/>	<input type="checkbox"/>	<input type="checkbox"/>	<input type="checkbox"/>	<input type="checkbox"/>
G08: Sports Related Factors	<input type="checkbox"/>	<input type="checkbox"/>	<input type="checkbox"/>	<input type="checkbox"/>	<input type="checkbox"/>

## APPENDIX 2: NORMALITY DISTRIBUTION AMONG FACTORS AND GROUPS

### GROUPS

The following figures illustrate the normality distribution for all factors:

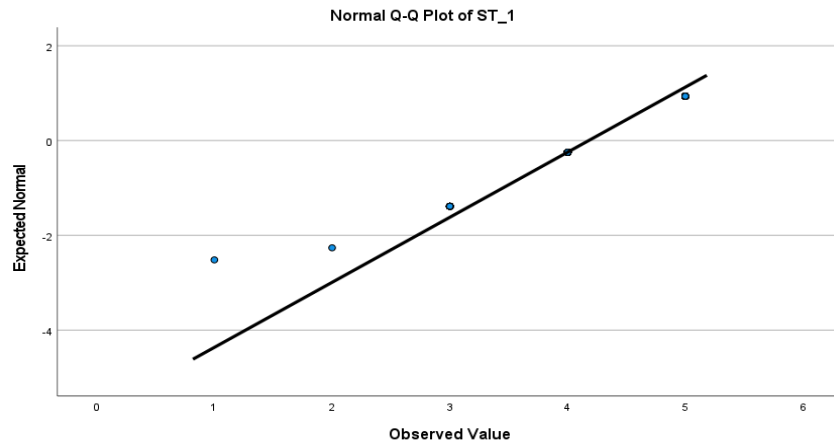

Graph 1. ST\_1 Normality

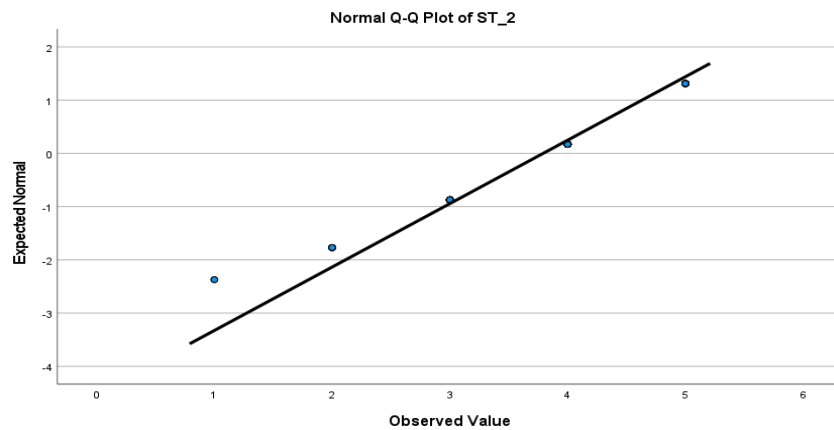

Graph 2. ST\_2 Normality

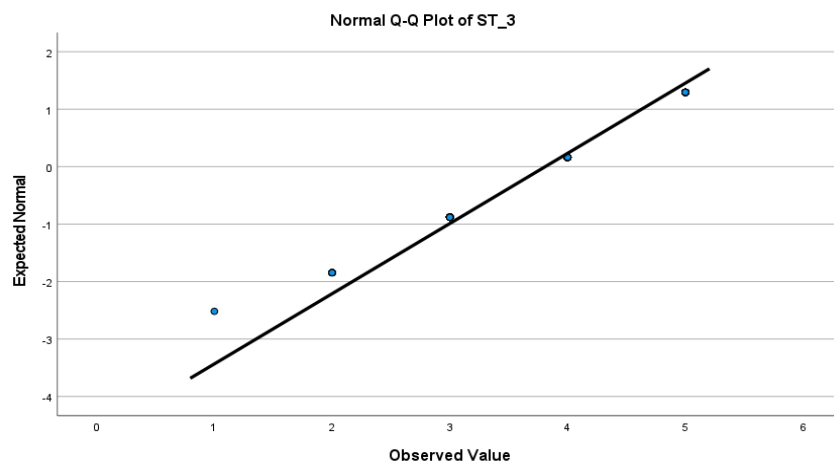

Graph 3. ST\_3 Normality



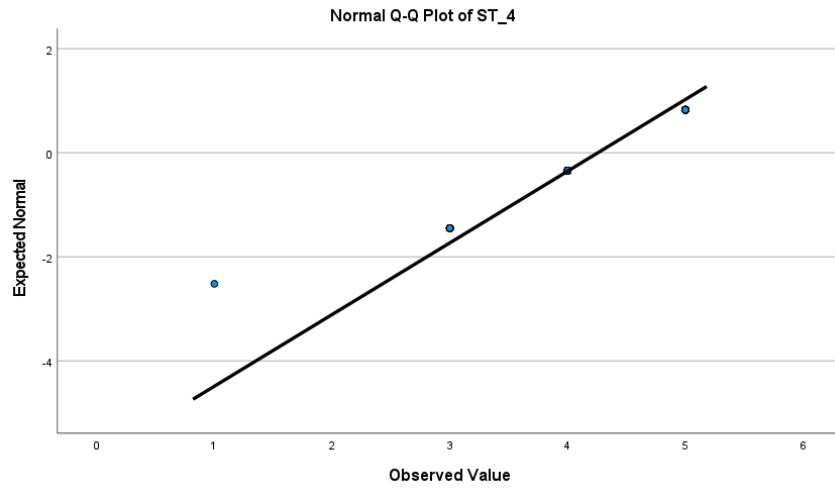

Graph 4. ST\_4 Normality

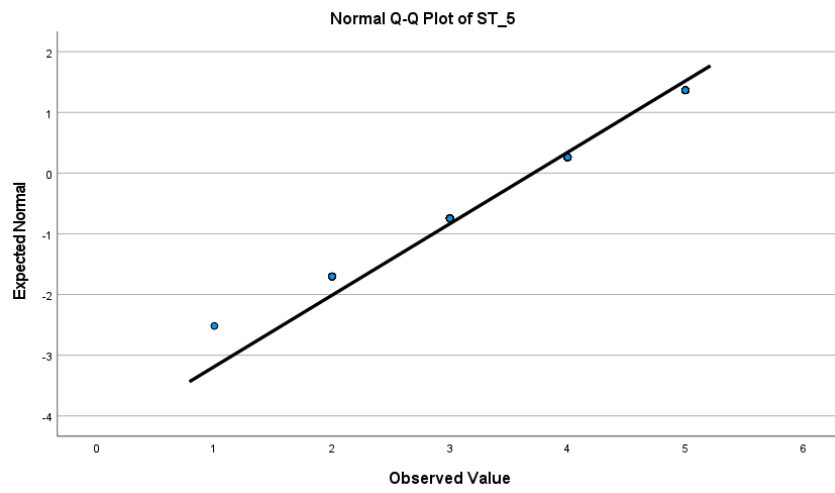

Graph 5. ST\_5 Normality

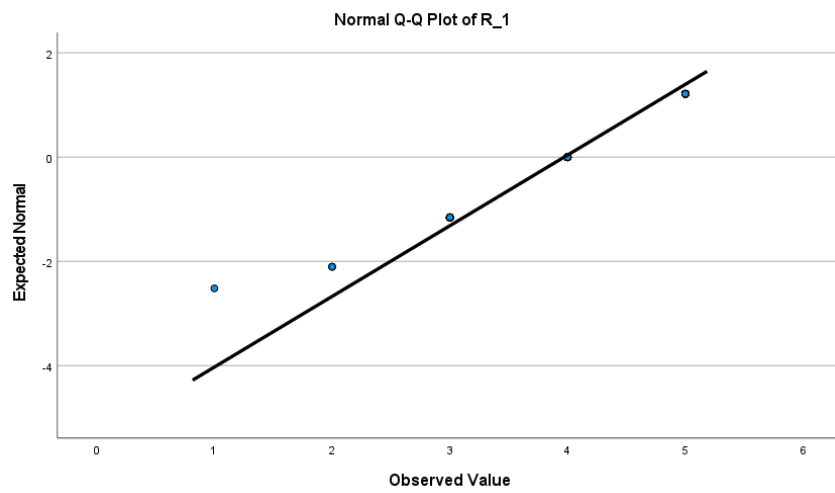

Graph 6. R\_1 Normality

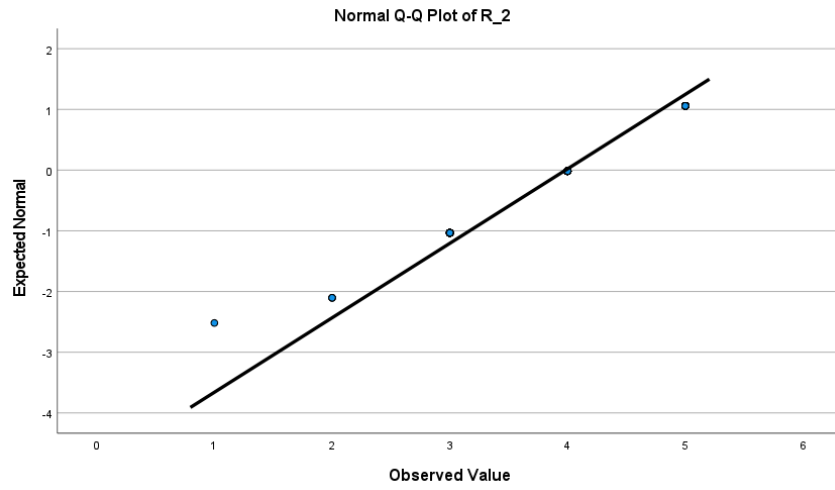

Graph 7. R\_2 Normality

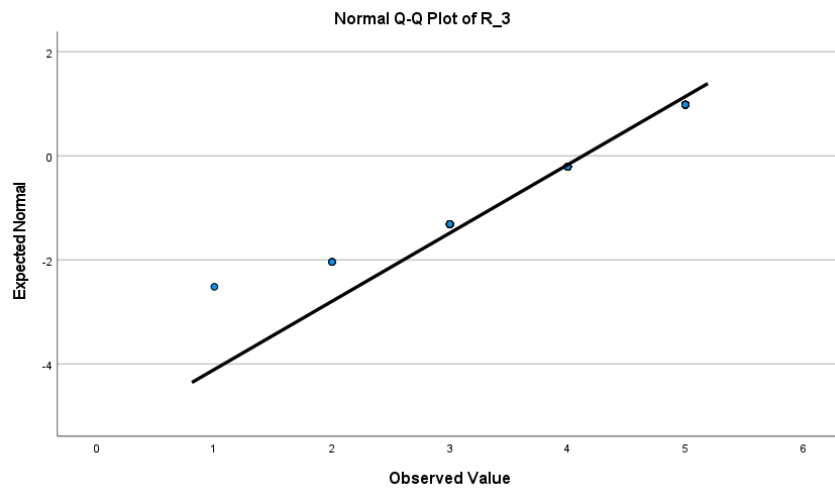

Graph 8. R\_3 Normality

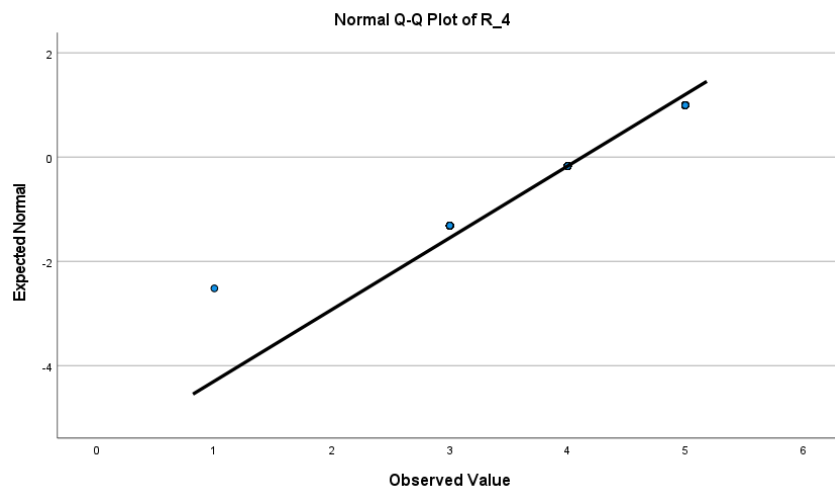

Graph 9. R\_4 Normality

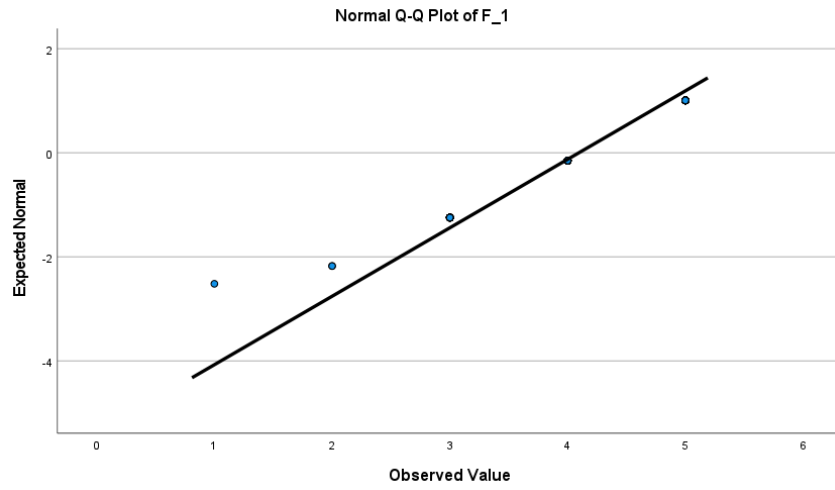

Graph 10. F\_1 Normality

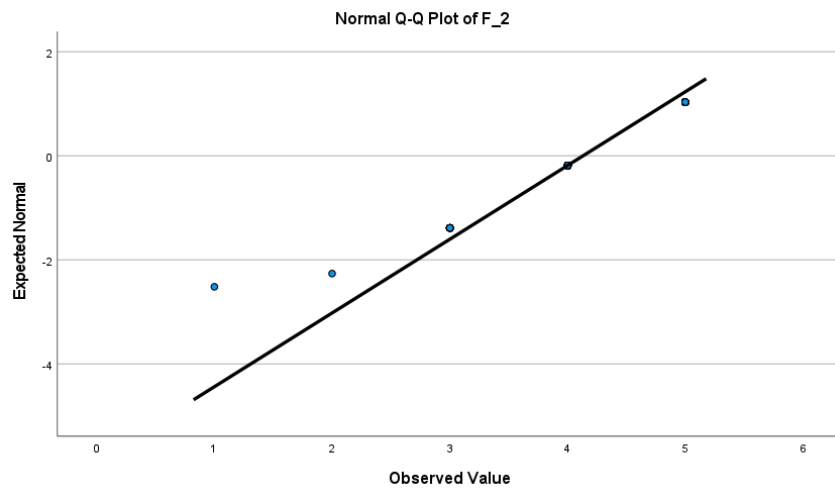

Graph 11. F\_2 Normality

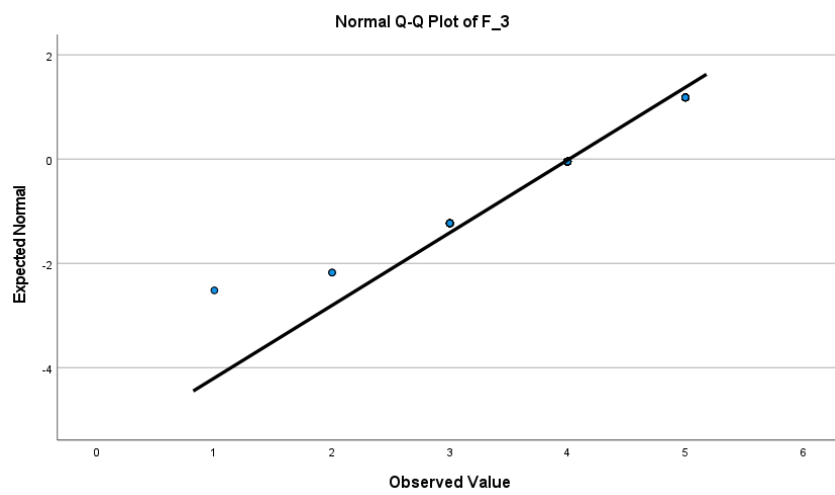

Graph 12. F\_3 Normality

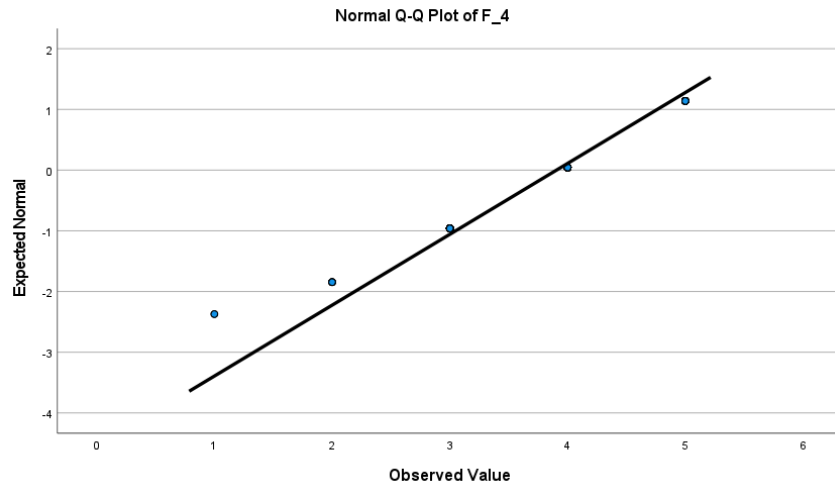

Graph 13. F\_4 Normality

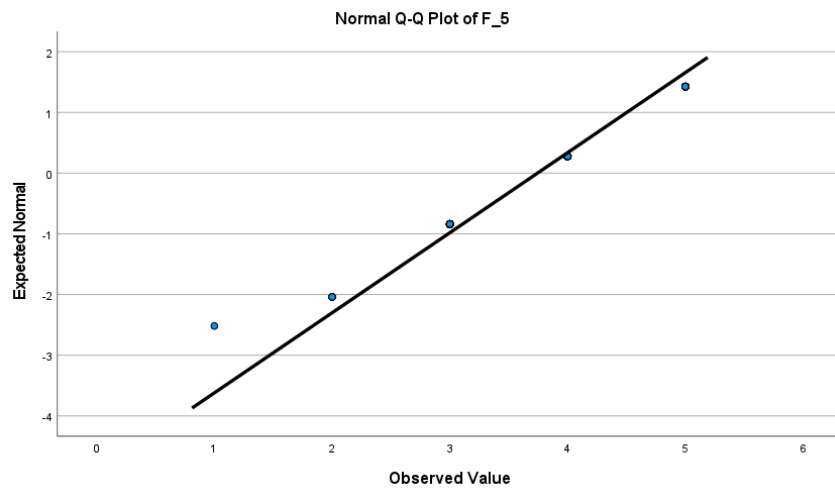

Graph 14. F\_5 Normality

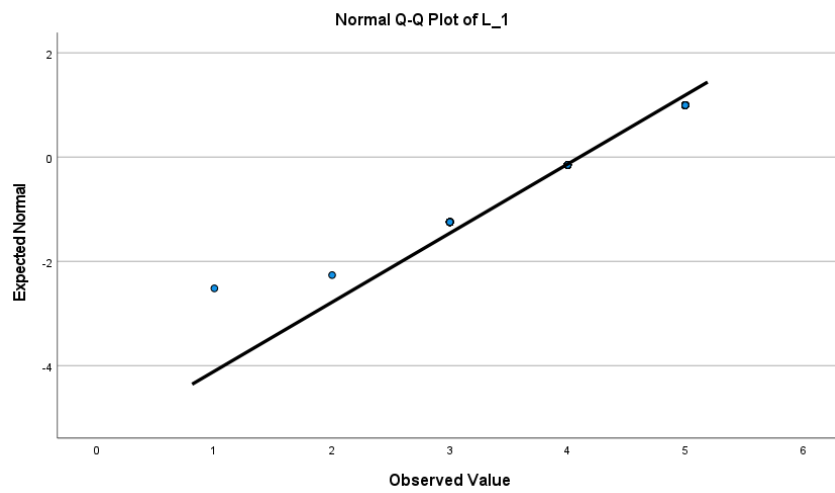

Graph 15. L\_1 Normality

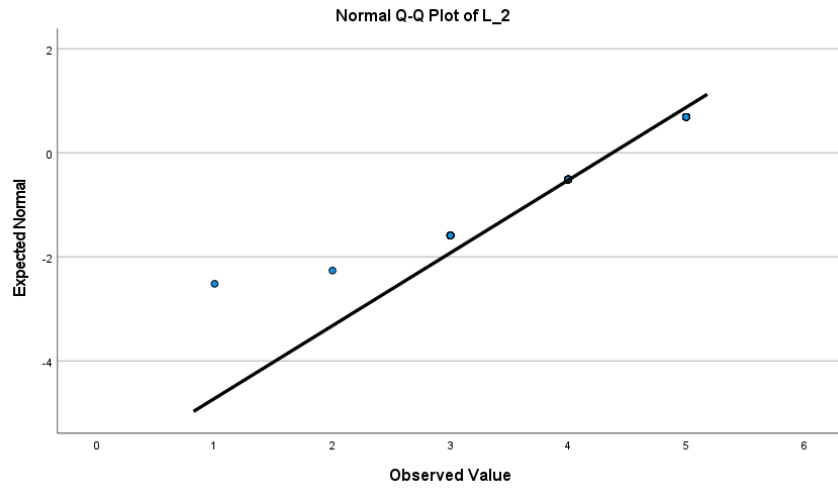

Graph 16. L\_2 Normality

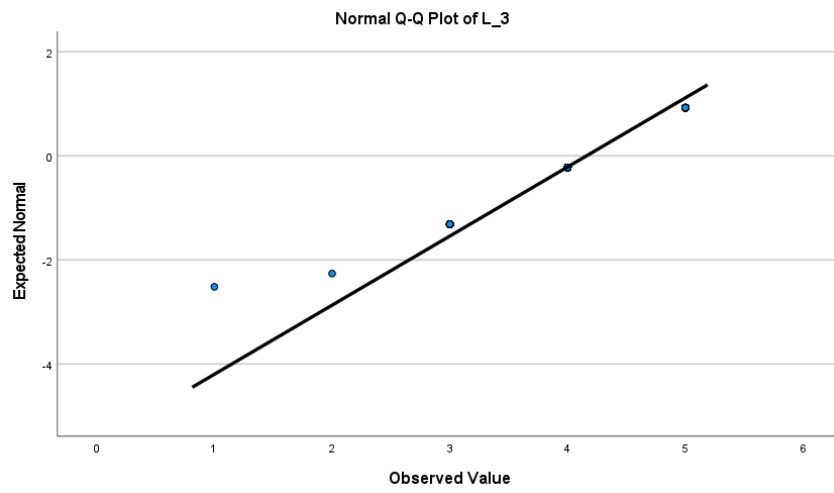

Graph 17. L\_3 Normality

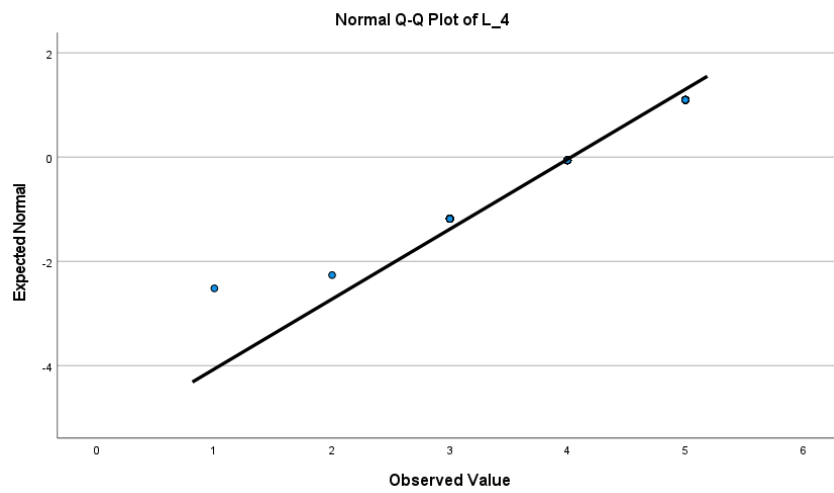

Graph 18. L\_4 Normality

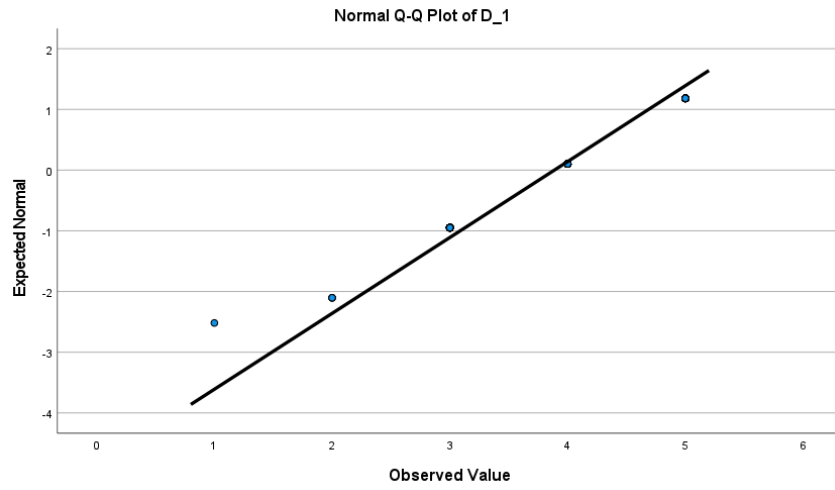

Graph 19. D\_1 Normality

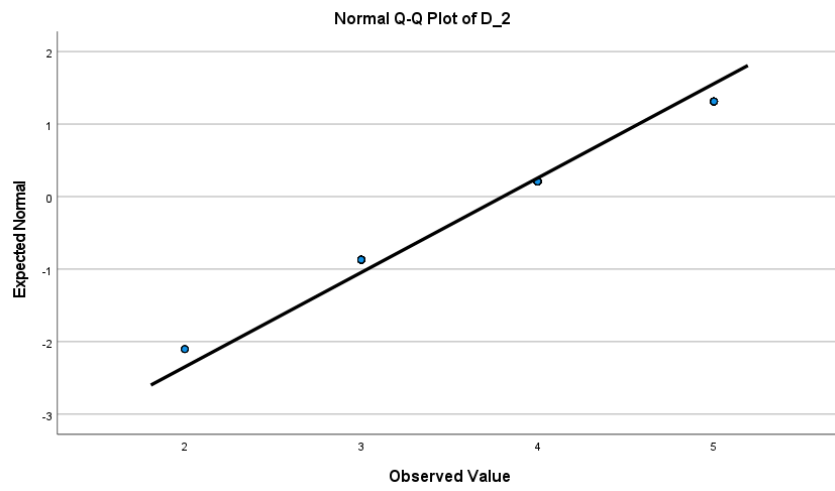

Graph 20. D\_2 Normality

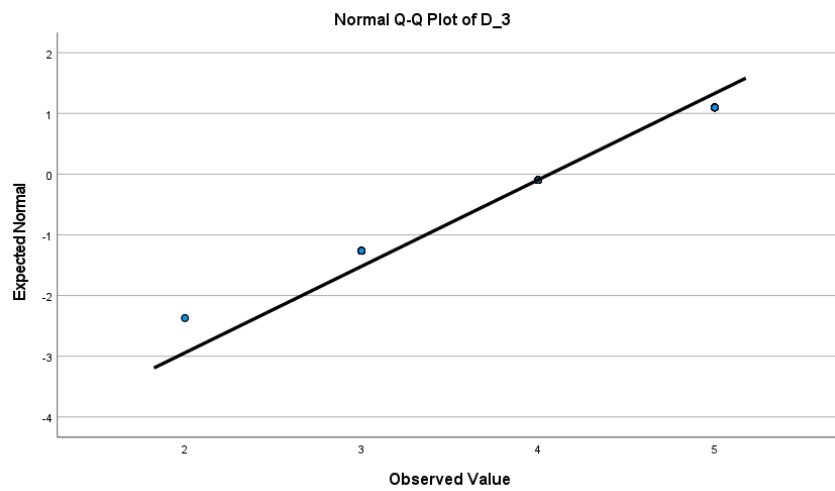

Graph 21. D\_3 Normality

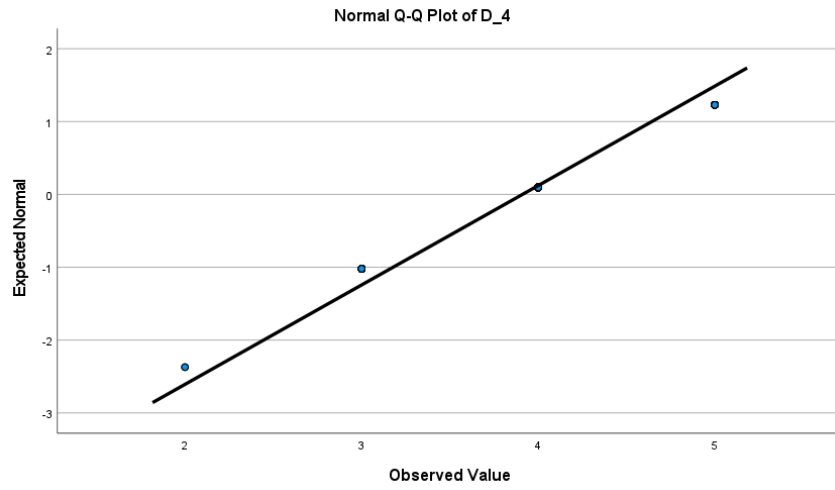

Graph 22. D\_4 Normality

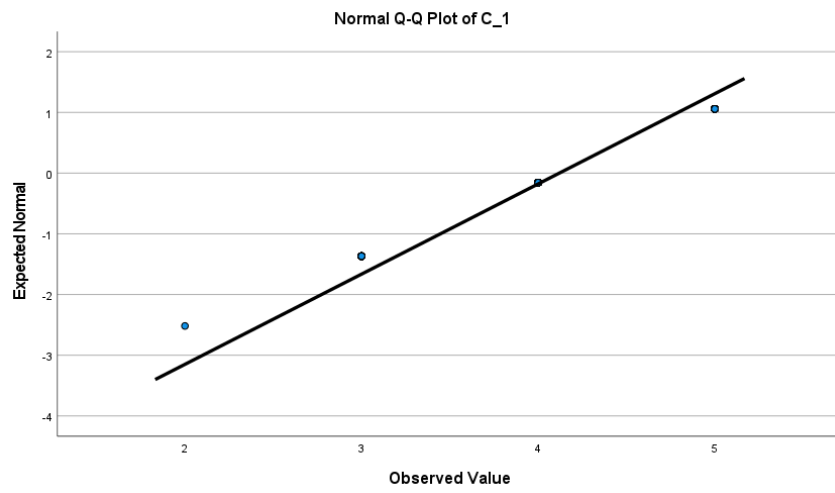

Graph 23. C\_1 Normality

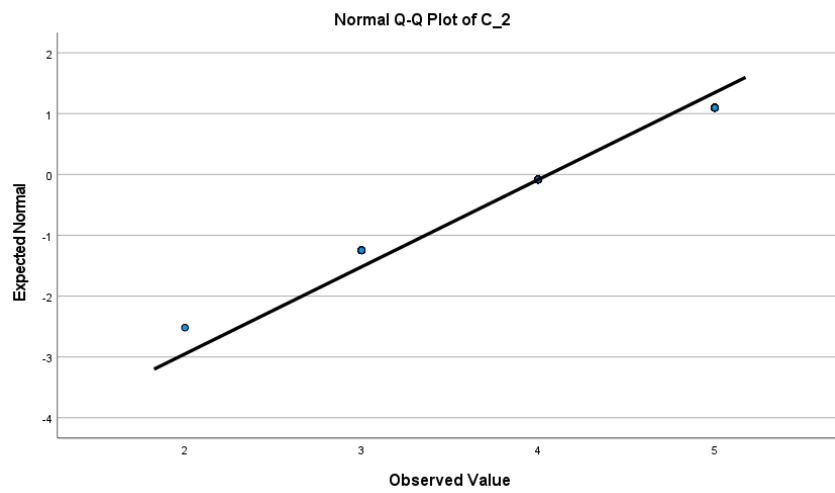

Graph 24. C\_2 Normality

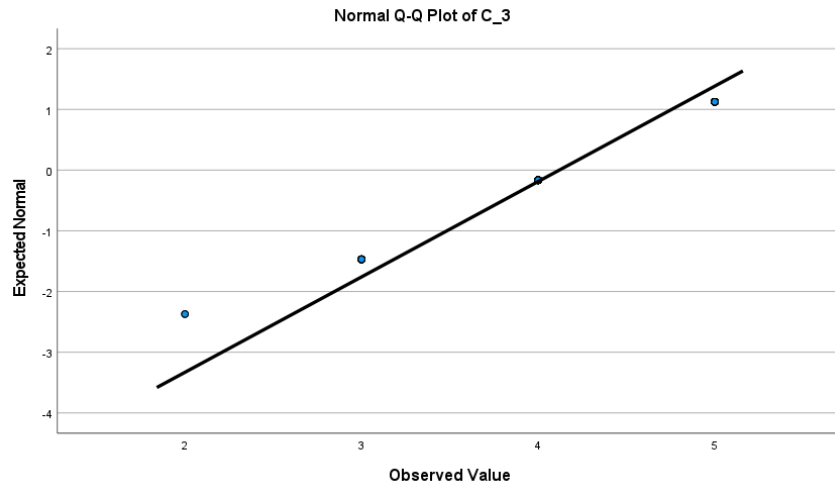

Graph 25. C\_3 Normality

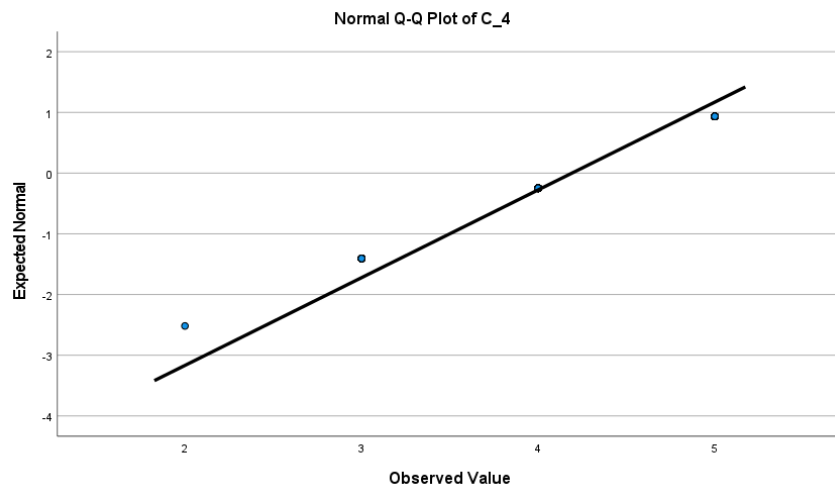

Graph 26. C\_4 Normality

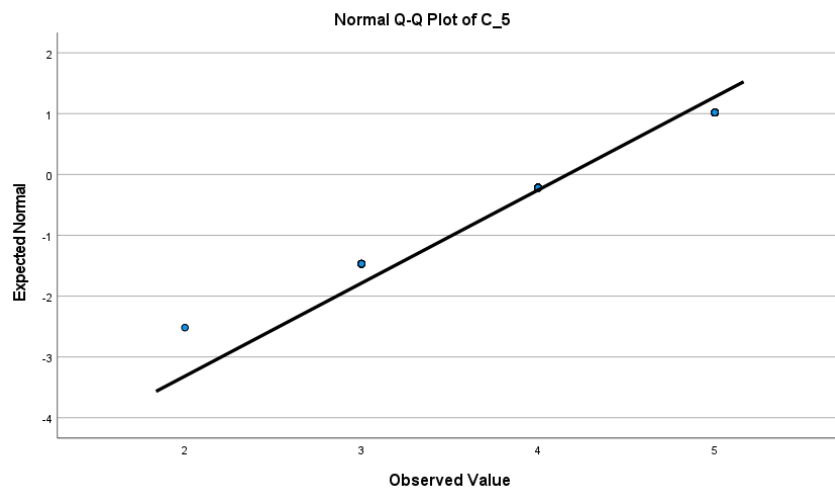

Graph 27. C\_5 Normality



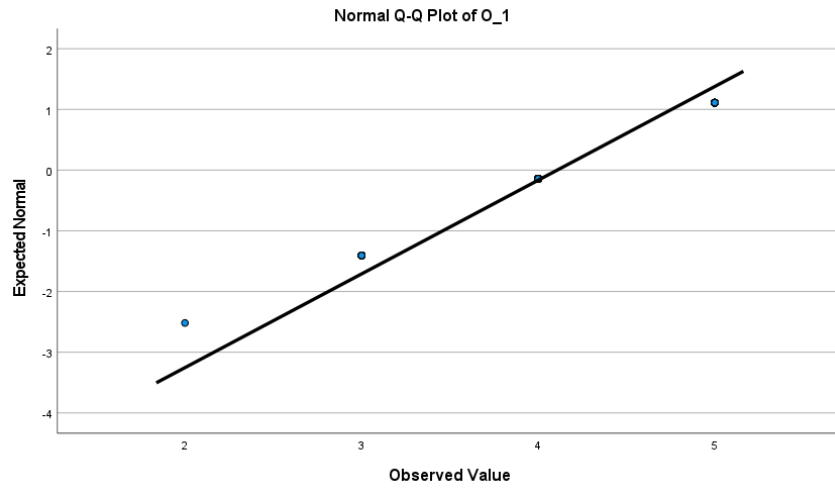

Graph 28. O\_1 Normality

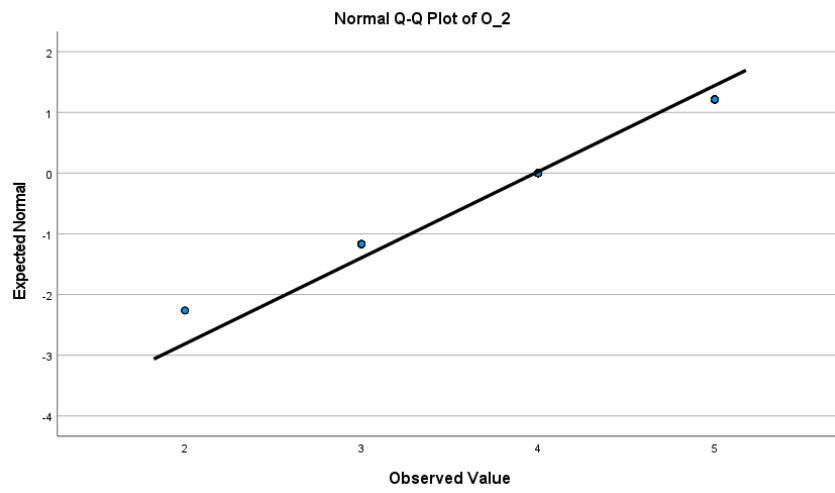

Graph 29. O\_2 Normality

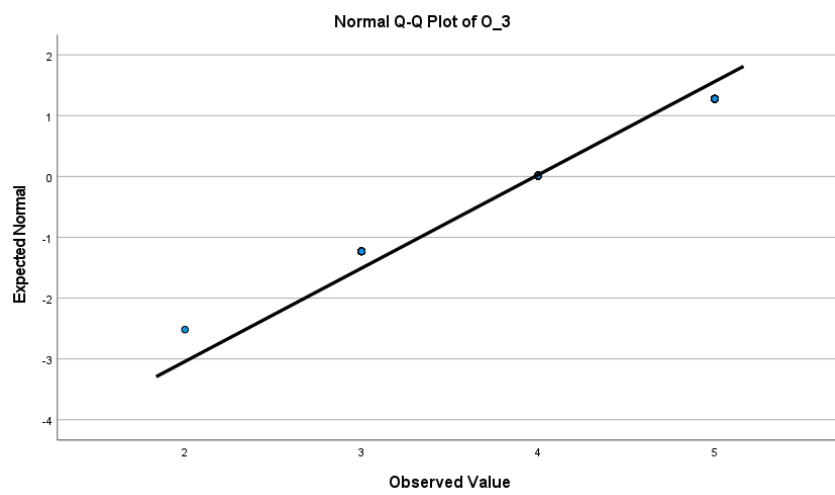

Graph 30. O\_3 Normality

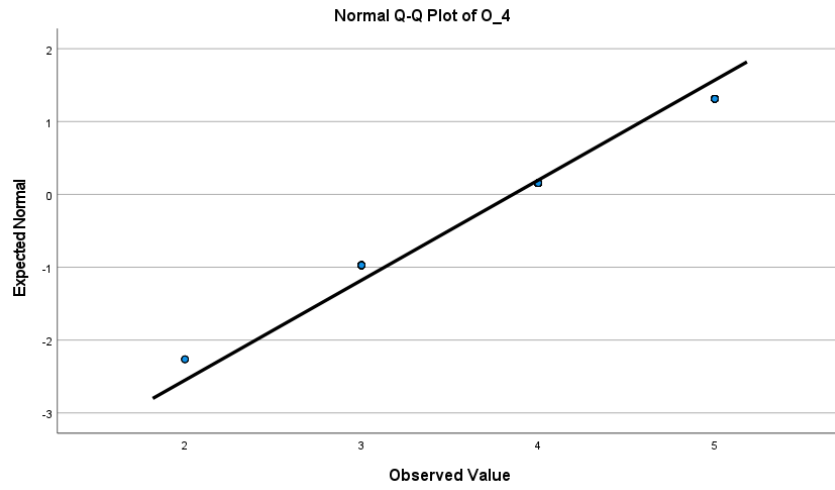

Graph 31. O\_4 Normality

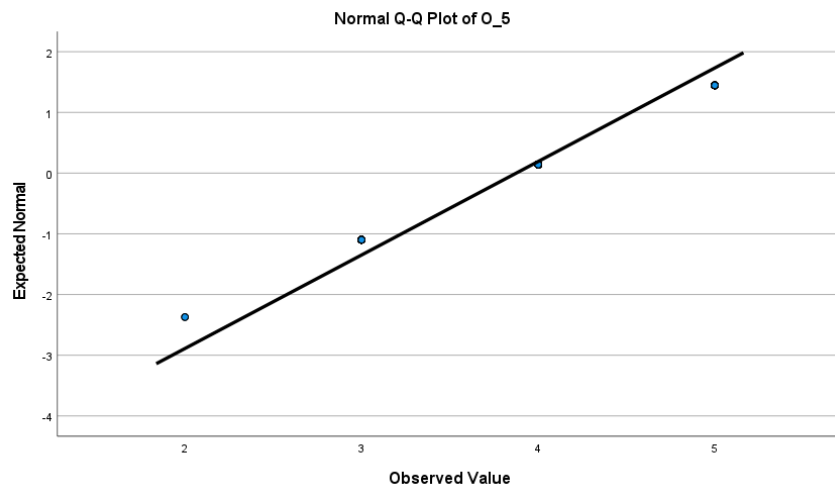

Graph 32. O\_5 Normality

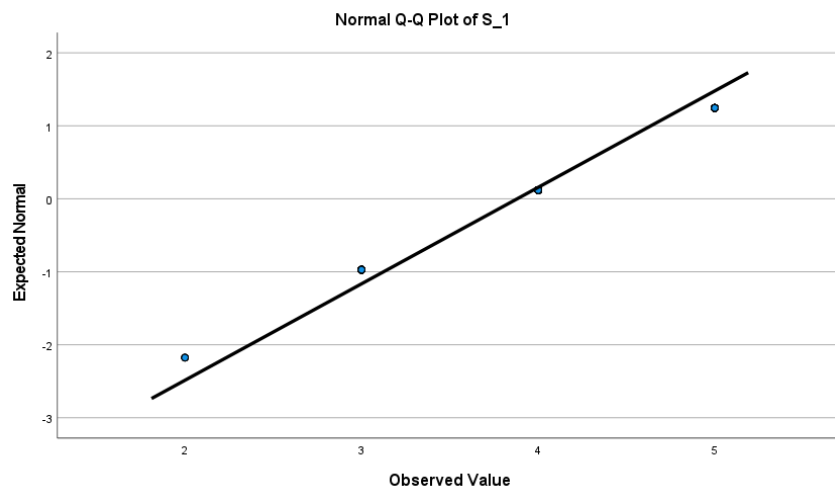

Graph 33. S\_1 Normality

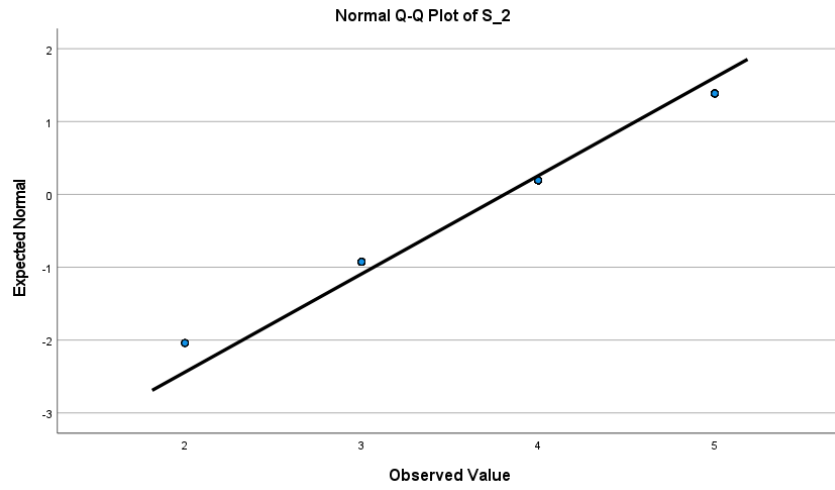

Graph 34. S\_2 Normality

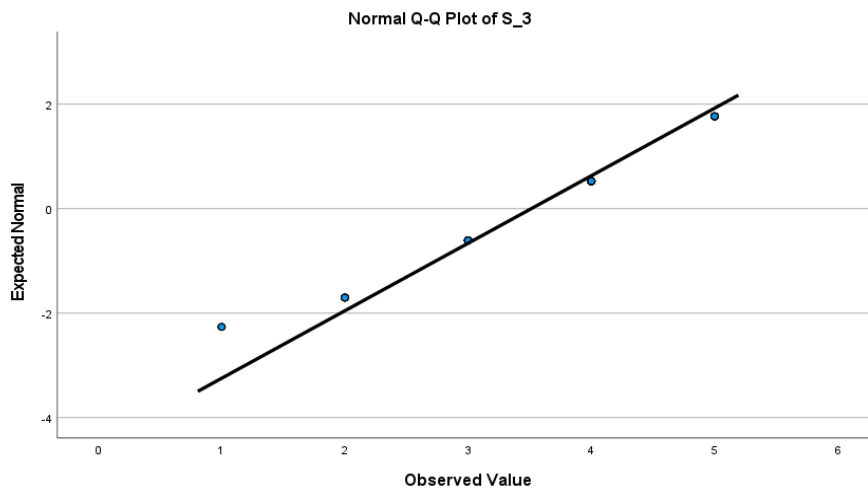

Graph 35. S\_3 Normality

The following Figures illustrate the normality distribution for the groups:

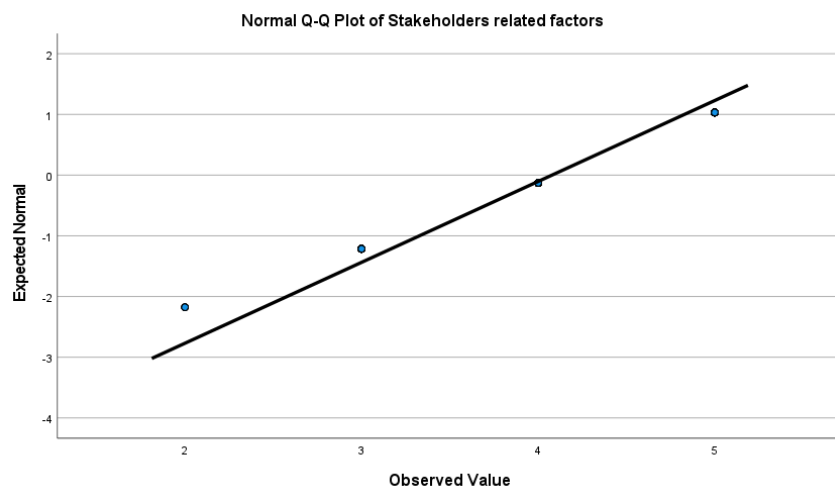

Graph 36. Stakeholder Group Normality

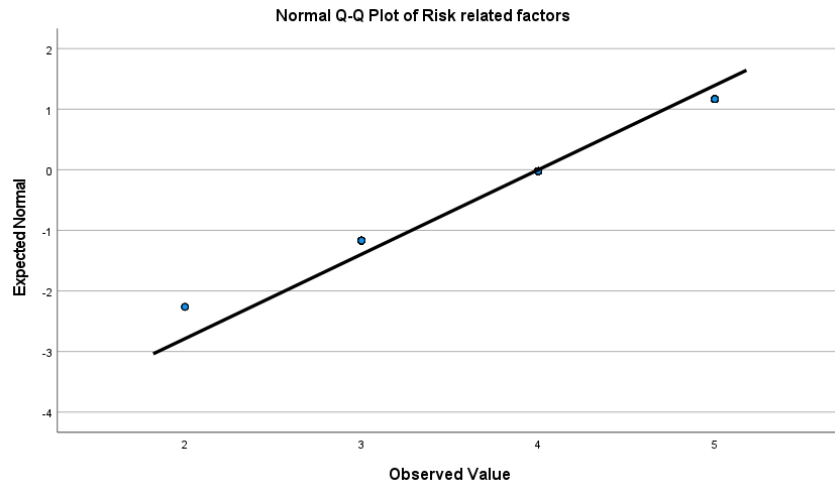

Graph 37. Risk Group Normality

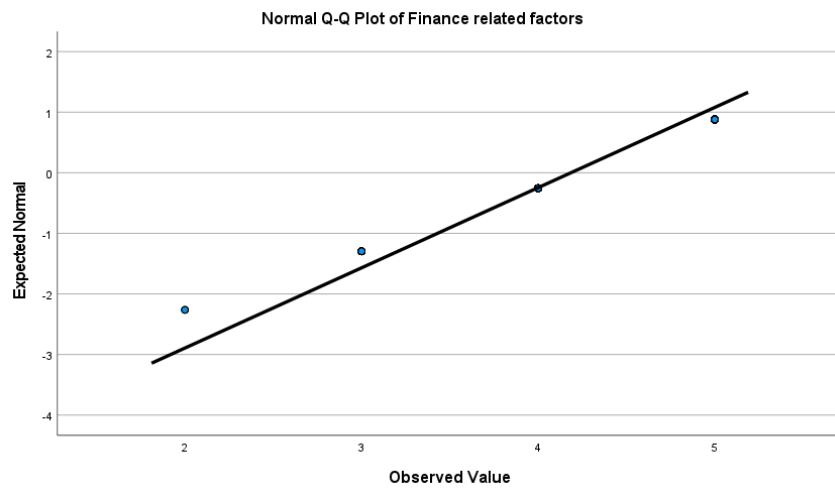

Graph 38. Finance Group Normality

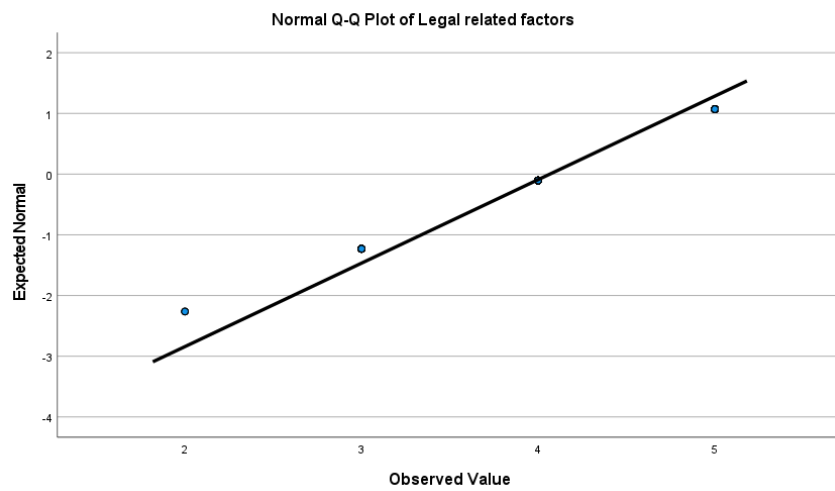

Graph 39. Legal Group Normality

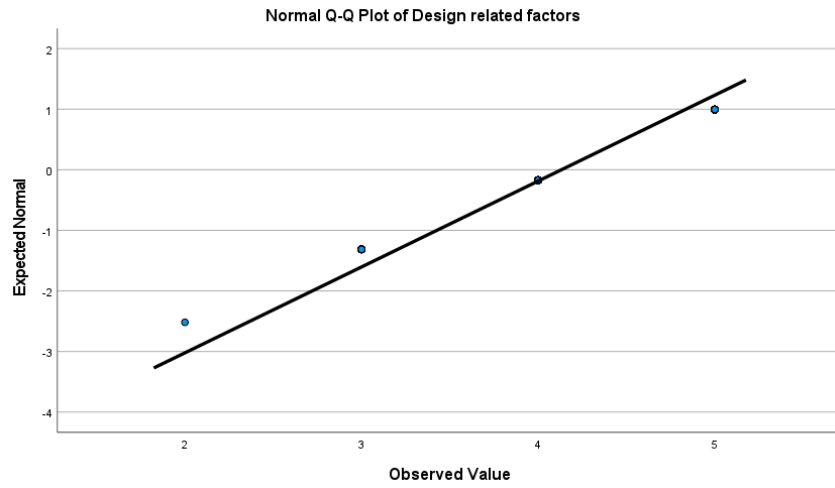

Graph 40. Design Group Normality

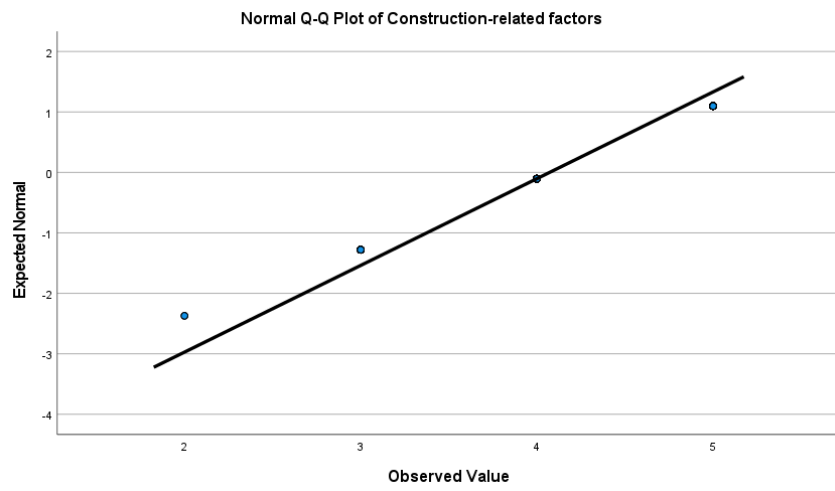

Graph 41. Construction Group Normality

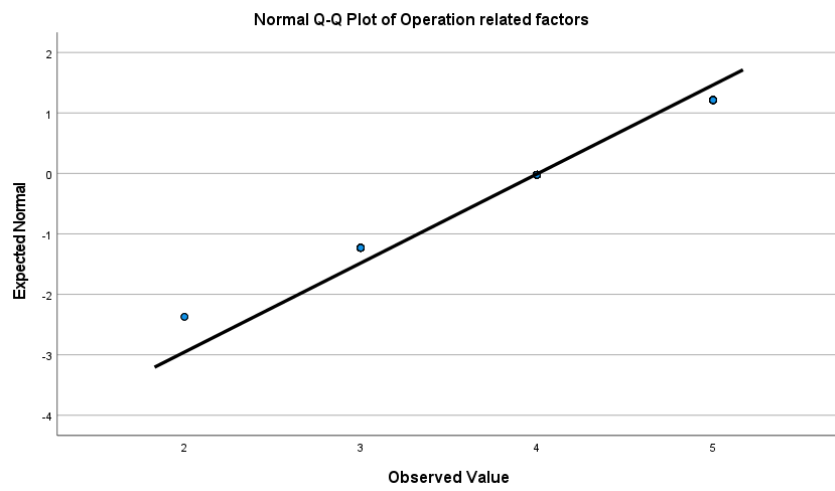

Graph 42. Operation Group Normality

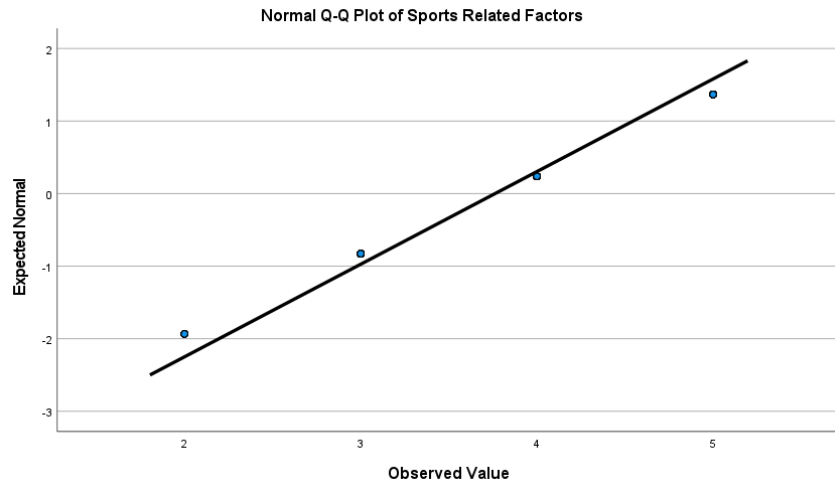

Graph 43. Sports Group Normality